

# Sk PRO HAMMOND STAGE KEYBOARD

Model: SK PRO/SK PRO-73

Thank you, and congratulations on your choice of the Hammond SK PRO/SK PRO-73 Stage Keyboard.

The Hammond SK PRO/SK PRO-73 features authentic Hammond Organ Sound along with high-quality Piano, Ensemble and Mono Synth sections to make it the perfect instrument for all musical occasions. The SK PRO has 61 keys and the SK PRO-73 has 73 keys.

Please take the time to read this Manual completely in order to take full advantage of the many features of your SK PRO/SK PRO-73, and please retain it for future reference.

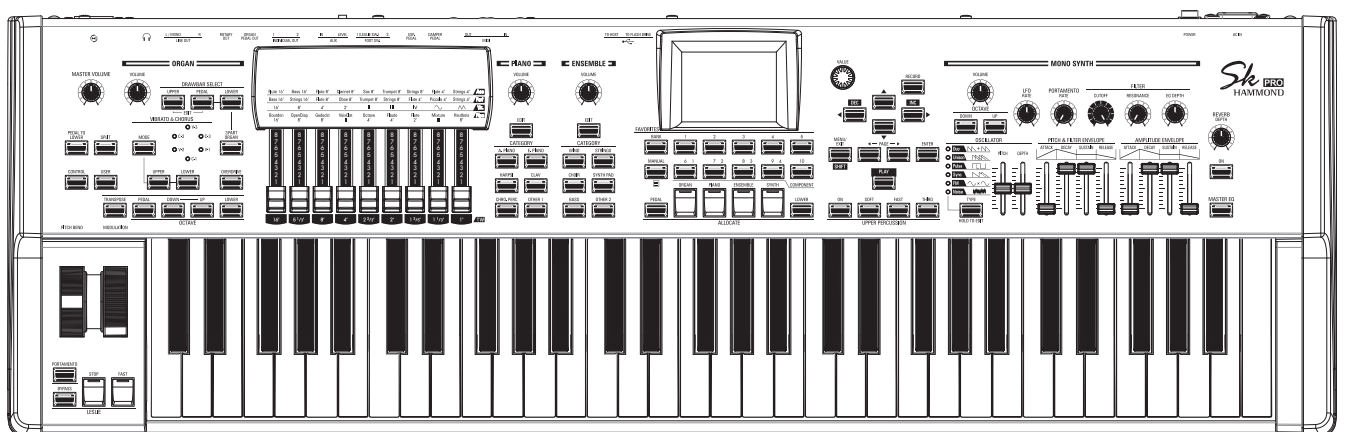

## Owner's Manual

# IMPORTANT SAFETY INSTRUCTIONS

Read these instructions.

Keep these instructions.

Heed all warnings.

Follow all instructions.

Do not use this apparatus near water.

Clean only with dry cloth.

Do not block any ventilation openings.

Install in accordance with the manufacturer's instructions.

Do not install near any heat sources such as radiators, heat registers, stoves or other apparatus (including amplifiers) that produce heat.

Do not defeat the safety purpose of the polarized or grounding-type plug. A polarized plug has two blades with one wider than the other. A grounding type plug has two blades and a third grounding prong. The wider blade or third prong is provided for your safety. If the provided plug does not fit into your outlet, consult an electrician for replacement of the obsolete outlet.

Protect the power cord from being walked on or pinched, particularly at plugs, convenience receptacles, and the point where they exit from the apparatus.

Only use attachments/accessories specified by the manufacturer.

Use only with the cart, stand, tripod, bracket, or table specified by the manufacturer, or sold with the apparatus. When cart is used: use caution when moving the cart/apparatus combination to avoid injury from tip-over.

PORTABLE CART WARNING



S3125A

Unplug this apparatus during lightning storms, or when unused for long periods of time.

Refer all servicing to qualified service personnel. Servicing is required when the apparatus has been damaged in any way, such as power-supply cord or plug is damaged, liquid has been spilled or objects have fallen into the apparatus, the apparatus has been exposed to rain or moisture, does not operate normally, or has been dropped.

Apparatus shall not be exposed to dripping or splashing and no objects filled with liquids, such as vases, shall be placed on the apparatus.



**WARNING:** To reduce the risk of fire or electric shock, do not expose this apparatus to rain or moisture.

**ATTENTION:** Pour réduire les risques de choc électrique ou d'incendie, ne pas exposer cet appareil à la pluie ou à l'humidité.

-THIS APPARATUS MUST BE EARTHED.

-The socket-outlet shall be installed near the apparatus and shall be easily accessible.



	The lightning flash with arrowhead symbol within an equilateral triangle, indicates that dangerous voltage constituting a risk of electric shock is present within this unit.
	The exclamation point within equilateral triangle, indicates that there are important operating and maintenance instructions in the literature accompanying this unit.

## FOR THE USA



NOTE: This equipment has been tested and found to comply with the limits for a Class B digital unit, pursuant to part 15 of the FCC rules. These limits are designed to provide reasonable protection against harmful interference in a residential installation. This equipment generates, uses and can radiate radio frequency energy and, if not installed and used in accordance with the instructions, may cause harmful interference to radio communications. However, there is no guarantee that interference will not occur in a particular installation. If this equipment does cause harmful interference to radio or television reception, which can be determined by turning the equipment off and on, the user is encouraged to try to correct the interference by one or more of the following measures:

- ◆ Reorient or relocate the receiving antenna.
- ◆ Increase the separation between the equipment and receiver.
- ◆ Connect the equipment into an outlet on a circuit different from that to which the receiver is connected.
- ◆ Consult the dealer or an experienced radio/TV technician for help.

## FOR CANADA

This class B digital apparatus complies with Canadian ICES-003.

Cet appareil numérique de la classe B est conforme à la norme NMB-003 du Canada.

## FOR EU COUNTRIES



In case in the future your instrument gets too old to play/use or malfunctions beyond repair, please observe the instructions of this mark, or, if any question, be sure to contact your dealer or your nearest town or municipal office for its proper disposal.

## FOR UNITED KINGDOM

FOR YOUR SAFETY, PLEASE READ THE FOLLOWING TEXT CAREFULLY

This appliance is supplied with a molded 3-pin mains plug for your safety and convenience.

The plug contains a 13 amp fuse.

Should the fuse need to be replaced, please ensure that the replacement fuse has a rating of 13 amps and that it is approved by ASTA or BSI to BS11362.

Check for the ASTA mark  or the BSI mark  on the body of the fuse.

If the plug contains a removable fuse cover, you must ensure that it is refitted when the fuse is replaced.

If the fuse cover is lost, the plug must not be used until a replacement cover is obtained.

A replacement fuse cover can be obtained from your local Hammond Dealer.

IF THE FITTED MOULDED PLUG IS UNSUITABLE FOR THE SOCKET OUTLET IN YOUR HOME, THEN THE FUSE SHOULD BE REMOVED AND THE PLUG CUT OFF AND DISPOSED OF SAFELY.

THERE IS A DANGER OF SEVERE ELECTRICAL SHOCK IF THE CUT-OFF PLUG IS INSERTED INTO ANY 13 AMP SOCKET.

To replace the fuse, open the fuse compartment with a screwdriver and replace the fuse and fuse cover.

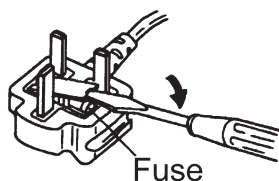

# IMPORTANT - PLEASE READ

## POWER SUPPLY

1. Do not use this unit on the same power circuit with any device that will generate line noise (such as an electric motor or variable lighting system).
2. Before connecting this unit to other devices, turn off the power to all units. This will help prevent malfunctions and/or damage to speakers or other devices.
3. This unit features an Auto Power Off function that automatically turns the power off if the unit is not operated for a specified period of time. The setting will revert to its default value if not backed up before the power is turned off.

## PLACEMENT

1. Using the unit near power amplifiers (or other equipment containing large power transformers) may induce hum. To alleviate the problem, change the orientation of this unit; or move it farther away from the source of interference.
2. This device may interfere with radio and television reception. Do not use this device in the vicinity of such receivers.
3. Noise may be produced if wireless communications devices, such as cell phones, are operated in the vicinity of this unit. Such noise could occur when receiving or initiating a call, or while conversing. Should you experience such problems, you should relocate such wireless devices so they are at a greater distance from this unit, or switch them off.
4. Do not expose the unit to direct sunlight, place it near devices that radiate heat, leave it inside an enclosed vehicle, or otherwise subject it to temperature extremes. Also, do not allow lighting devices that normally are used while their light source is very close to the unit (such as a piano light), or powerful spotlights to shine upon the same area of the unit for extended periods of time. Excessive heat can deform or discolor the unit.
5. When moved from one location to another where the temperature and/or humidity is very different, water droplets (condensation) may form inside the unit. Damage or malfunction may result if you attempt to use the unit in this condition. Therefore, before using the unit, you must allow it to stand for several hours, until the condensation has completely evaporated.
6. Do not allow rubber, vinyl, or similar materials to remain on the unit for long periods of time. Such objects can discolor or otherwise harmfully affect the finish.
7. Do not paste stickers, decals, or the like to this instrument. Peeling such matter off the instrument may damage the exterior finish.

## MAINTENANCE

8. To clean the unit, use a dry, soft cloth; or one that is slightly dampened.
9. To remove stubborn dirt off plastic parts, use a cloth impregnated with a mild, non-abrasive detergent. Afterwards, be sure to wipe the unit thoroughly with a soft, dry cloth. Try to wipe the entire surface using an equal amount of strength, moving the cloth along with the grain of the wood. Rubbing too hard in the same area can damage the finish.
10. Never use benzine, thinners, alcohol or solvents of any kind,

to avoid the possibility of discoloration and/or deformation.

## ADDITIONAL PRECAUTIONS

1. Please be aware that the contents of memory can be irretrievably lost as a result of a malfunction, or the improper operation of the unit. To protect yourself against the risk of losing important data, we recommend that you periodically save a backup copy of important data you have stored in the unit's memory in USB Flash Drive.
2. Unfortunately, it may be impossible to restore the contents of data that was stored in another MIDI device (e.g., a sequencer) once it has been lost. Hammond assumes no liability concerning such loss of data.
3. Use a reasonable amount of care when using the unit's buttons, sliders, or other controls; and when using its jacks and connectors. Rough handling can lead to malfunctions.
4. When connecting / disconnecting all cables, grasp the connector itself - never pull on the cable. This will avoid causing short circuits, or damage to the cable's internal elements.
5. To avoid disturbing your neighbors, try to keep the unit's volume at reasonable levels. You may prefer to use headphones, so you do not need to be concerned about those around you (especially when it is late at night).
6. When you need to transport the unit, package it in the box (including padding) that it came in, if possible. Otherwise, you will need to use equivalent packaging materials.



**INTRODUCTION**

# Table Of Contents

IMPORTANT SAFETY INSTRUCTIONS.....	2	USING ORGAN PATCHES.....	30
IMPORTANT - PLEASE READ.....	4	ALLOCATING THE SECTION TO THE KEYBOARD.....	30
<b>INTRODUCTION .....</b>	<b>5</b>	RECALLING A PATCH.....	30
NAMES AND FUNCTIONS .....	10	ADJUSTING THE VOLUME.....	31
CONTROL PANEL.....	10	CHANGING THE OCTAVE.....	31
LEFT SIDE OF THE KEYBOARD .....	12	CREATING AN ORGAN PATCH.....	32
REAR PANEL.....	12	SELECT [MANUAL].....	32
KEYBOARD.....	14	INITIALIZE "MANUAL".....	32
ACCESSORY.....	14	ALLOCATE THE SECTION TO THE KEYBOARD.....	32
ACCESSORIES (SOLD SEPARATELY).....	14	SELECT 3 PART ORGAN.....	32
<b>MAKING THE CONNECTIONS .....</b>	<b>15</b>	SELECT THE ORGAN TYPE.....	32
BASIC CONNECTIONS .....	16	SELECT THE PART TO ADJUST .....	33
CONNECTING A LESLIE SPEAKER .....	17	ADD DRAWBARS.....	33
BASIC CONNECTION.....	17	ADJUST THE VOLUME.....	33
3-CHANNEL TYPE (2101/mk2) .....	17	CHANGING THE OCTAVE.....	33
SINGLE-CHANNEL TYPE (122XB, 981, 3300/W).....	17	ADDING PERCUSSION.....	34
OTHER AUDIO CONNECTIONS.....	18	ADDING EFFECTS TO THE ORGAN SECTION .....	34
OUTPUT DRY ORGAN SOUNDS .....	18	VIBRATO & CHORUS.....	34
ROTARY OUT jack.....	18	LESLIE.....	35
ORGAN PEDAL OUT jack.....	18	OTHER EFFECTS.....	35
USING AN EXTERNAL MIXER.....	19	ORGAN SECTION IN DETAIL .....	36
INDIVIDUAL OUT jacks.....	19	KEYBOARDS AND PARTS.....	36
USING A MUSIC PLAYER.....	19	ORGAN TYPES.....	37
AUX IN jack.....	19	TONE WHEEL (A-100, B-3, C-3) .....	37
EXPANDING THE SK PRO.....	20	MELLOW .....	37
DUAL MANUAL OPERATION .....	20	TRANSISTOR (Vx, Farf, Ace).....	37
TWO MANUALS + PEDALBOARD .....	21	PIPE.....	37
<b>TURN ON AND PLAY.....</b>	<b>23</b>	HARMONIC DRAWBARS™ .....	38
POWERING ON.....	24	DRAWBARS FOR THE UPPER AND LOWER PARTS.....	39
BACKING UP THE INITIAL SETTINGS.....	24	PEDAL DRAWBARS.....	39
AUTO POWER OFF.....	24	DRAWBAR REGISTRATION PATTERNS.....	40
RESTORING THE FACTORY SETTINGS .....	24	MODERN DRAWBAR REGISTRATIONS .....	41
STRUCTURE OF THE SK PRO.....	25	F1: Classic.....	44
SECTIONS .....	25	F2: Theatre 1.....	44
KEYBOARDS AND PARTS.....	25	F3: Theatre 2.....	44
PARTS.....	25	ORGAN SECTION OPERATION .....	45
MEMORY.....	25	MATCHING THE REGISTRATION TO THE DRAWBAR SETTING.....	45
PATCHES.....	25	SHOWING CURRENT SETTINGS .....	45
FACTORY, USER and BUNDLE .....	25	USING PIANO AND ENSEMBLE PATCHES.....	46
COMBINATIONS.....	25	ALLOCATING THE SECTION TO THE KEYBOARD.....	46
FAVORITES.....	25	RECALLING A PATCH.....	46
USING COMBINATIONS.....	26	ADJUSTING THE VOLUME.....	47
WHAT IS A "COMBINATION?".....	26	ADJUST THE VELOCITY SENSITIVITY .....	47
SELECT A COMBINATION .....	26	CHANGING THE OCTAVE.....	47
FAVORITES-FREQUENTLY USED COMBINATIONS .....	27	USING MONO SYNTH PATCHES .....	48
WHAT IS A "FAVORITE?".....	27	ALLOCATING THE SECTION TO THE KEYBOARD.....	48
BANK AND NUMBER.....	27	RECALLING A PATCH.....	48
LINKING A COMBINATION .....	27	ADJUSTING THE VOLUME .....	49
TO A FAVORITE.....	27	CHANGING THE OCTAVE.....	49
RECALLING A COMBINATION USING A [FAVORITE] BUTTON .....	27	CREATING A MONO SYNTH PATCH.....	50
USING CONTROLLERS.....	28	SELECT [MANUAL].....	50
INTERNAL CONTROLLERS.....	28	ALLOCATE THE SECTION TO THE KEYBOARD.....	50
EXPRESSION PEDAL.....	28	LOCATE THE MONO SYNTH CONTROLS .....	50
FOOT SWITCH.....	28	ADJUST THE VOLUME.....	50
DAMPER PEDAL.....	28	CHANGING THE OCTAVE.....	50
MANUAL .....	29	INITIALIZE "MANUAL".....	50
What is "MANUAL"?	29	SELECT AN OSCILLATOR.....	51
INITIALIZE "MANUAL".....	29	SLIDE THE PITCH (PORTAMENTO) .....	51
		ADJUST THE BRIGHTNESS (FILTER).....	51
		CHANGING THE SOUND OVER TIME (ENVELOPE) .....	51
		ADDING PERIODIC CHANGING (LFO).....	51
		SELECT THE WAVEFORM (OSCILLATOR TYPE).....	51
		ADJUST THE WAVEFORM (MODIFY).....	51
		ADDING EFFECTS .....	52

SHOWING CURRENT SETTINGS .....	52	DRAWBARS .....	82
WHAT IS AN "OSCILLATOR?" .....	52	UPPER & LOWER DRAWBARS .....	83
OSCILLATOR TYPES AND CHARACTERISTICS .....	53	PEDAL .....	83
<b>COMBINING THE SECTIONS AND PARTS .....</b>	<b>54</b>	CONTACT / SUSTAIN .....	84
SECTIONS AND KEYBOARDS .....	54	VIRTUAL MULTI-CONTACT .....	84
ALLOCATING THE SECTIONS .....	54	UPPER & LOWER SUSTAIN .....	84
KEYBOARD SPLIT .....	54	PERCUSSION .....	85
USING THE SPLIT FEATURE .....	55	LEVEL .....	85
CHANGING THE OCTAVE .....	55	DECAY .....	85
PEDAL TO LOWER .....	55	KEYBOARD .....	85
PEDAL SUSTAIN .....	55	DRAWBARS .....	85
<b>ADJUSTING THE SOUND DURING PERFORMANCE .....</b>	<b>56</b>	VIBRATO & CHORUS .....	86
REVERB .....	56	TONE WHEEL ORGAN .....	86
MASTER EQUALIZER .....	56	PEDAL .....	86
ADJUSTING THE MASTER EQUALIZER .....	57	TRANSISTOR ORGAN .....	86
<b>TRANSPOSE, TUNE .....</b>	<b>58</b>	PIPE ORGAN .....	86
TRANSPOSING THE ENTIRE KEYBOARD .....	58	MATCHING TRANSFORMER .....	87
MASTER TUNE .....	59	MATCHING TRANSFORMER .....	87
<b>RECORDING SETTINGS .....</b>	<b>60</b>	DEPTH .....	87
<b>USING THE DISPLAY .....</b>	<b>61</b>	LESLIE .....	88
USING THE DISPLAY .....	62	REVERB .....	88
<b>PLAY MODE .....</b>	<b>63</b>	CABINET .....	88
PLAY MODES .....	63	MULTI EFFECT 1 .....	89
HOW TO READ THE DISPLAY (COMBINATION) .....	63	OVERDRIVE .....	89
HOW TO READ THE DISPLAY (ORGAN Section) .....	64	MULTI EFFECT 2 .....	89
HOW TO READ THE DISPLAY (PIANO/ENSEMBLE Section) .....	64	EQUALIZER .....	89
HOW TO READ THE DISPLAY (MONO SYNTH Section) .....	65	<b>PIANO/ENSEMBLE .....</b>	<b>90</b>
APP (APPLICATION) MENU .....	65	EDITING THE PIANO/ENSEMBLE SECTIONS .....	90
<b>MENU MODE .....</b>	<b>66</b>	PAGES AND CONTENTS .....	90
HOW TO READ THE DISPLAY .....	66	APP (APPLICATION) MENU .....	91
OPERATION IN THIS MODE .....	66	GENERAL .....	91
MENU MODE CONTENTS .....	67	LOUDNESS .....	91
<b>FUNCTION MODE .....</b>	<b>68</b>	PITCH BEND .....	91
HOW TO READ THE DISPLAY .....	68	PORTAMENTO .....	91
OPERATION IN THIS MODE .....	68	MONO/POLY .....	91
APP (APPLICATION) MENU .....	68	LFO .....	92
EXAMPLE OF OPERATION .....	69	COMPONENT .....	93
<b>"SHORTCUTS" .....</b>	<b>71</b>	COMPONENT - BASIC .....	93
<b>IF YOU FREQUENTLY USE A CERTAIN PAGE .....</b>	<b>71</b>	COMPONENT - OSCILLATOR .....	94
REGISTER .....	71	COMPONENT - FILTER .....	96
DISPLAY THE RECORDED PAGE .....	71	COMPONENT - FILTER EG .....	96
<b>LOCKING THE DISPLAY .....</b>	<b>72</b>	COMPONENT - AMPLITUDE .....	96
<b>EDITING PARAMETERS .....</b>	<b>73</b>	COMPONENT - AMPLITUDE EG .....	97
COMBINATION .....	74	MULTI EFFECT 1 .....	97
EDITING PAGES AND PARAMETERS .....	74	OVERDRIVE .....	97
APP (APPLICATION) MENU .....	74	MULTI EFFECT 2 .....	97
SETTING .....	75	EQUALIZER .....	97
CONTROL .....	76	COPYING A COMPONENT .....	98
REVERB .....	77	INITIALIZING A PATCH OR COMPONENT .....	98
INTERNAL ZONE .....	78	COMPONENTS & POLYPHONY .....	98
KEYBOARDS .....	78	INITIALIZING A PATCH .....	99
EXTERNAL ZONE .....	78	INITIALIZING A COMPONENT .....	99
DIFFERENCE BETWEEN "VOLUME" AND "EXPRESSION" .....	79	<b>MONO SYNTH .....</b>	<b>100</b>
MESSAGE ON/OFF .....	79	EDITING THE MONO SYNTH SECTION .....	100
PANIC FUNCTION / PARAMETER RELOAD .....	79	PAGES AND PARAMETERS .....	100
<b>ORGAN .....</b>	<b>80</b>	APP (APPLICATION) MENU .....	100
EDITING THE ORGAN SECTION .....	81	GENERAL .....	101
PAGES AND PARAMETERS .....	81	LOUDNESS .....	101
APP (APPLICATION) MENU .....	81	PITCH BEND .....	101
GENERAL .....	82	PORTAMENTO .....	101
LOUDNESS .....	82	KEY .....	101
PITCH BEND .....	82	LFO .....	102
		OSCILLATOR .....	103
		FILTER .....	103
		PITCH & FILTER EG .....	104
		AMPLITUDE .....	104

AMPLITUDE EG .....	104	RECORDING SYSTEM PARAMETERS .....	141
MULTI EFFECT 1 .....	105	DELETE .....	142
OVERDRIVE .....	105	DEFAULT .....	143
MULTI EFFECT 2.....	105	INFORMATION .....	144
EQUALIZER.....	105	STATUS DISPLAY .....	144
SECTION EFFECTS.....	106	IS ACTIVE .....	144
MULTI EFFECT 1 .....	106	VERSION - FIRMWARE .....	144
OVERDRIVE .....	106	VERSION - CONTENTS .....	144
MULTI EFFECT 2.....	106	UPDATE .....	144
EQUALIZER.....	106	UPDATING THE SOFTWARE .....	145
MULTI EFFECT 1 .....	107	PREPARING OPERATING TIME.....	145
MULTI EFFECT 1 .....	107	<b>MIDI .....</b>	<b>147</b>
Tremolo.....	107	MIDI .....	148
Wah-Wah.....	108	CHANNEL MESSAGES.....	149
Ring Modulator (Ring Mod.).....	109	SYSTEM MESSAGES / SYSTEM EXCLUSIVE MESSAGES .....	149
Compressor .....	110	MEMORY DUMP .....	149
OVERDRIVE .....	111	MIDI STRUCTURE OF THE SK PRO .....	150
MULTI EFFECT 2.....	112	KEYBOARD (INTERNAL) CHANNELS .....	150
MULTI EFFECT 2 .....	112	EXTERNAL ZONES.....	150
Auto Pan.....	112	EXPANDED KEYBOARDS.....	150
Phaser.....	113	USING AN EXTERNAL SEQUENCER.....	152
Flanger .....	113	RECORDING AND PLAYING BACK A PERFORMANCE .....	152
Chorus.....	114	RECORD.....	152
Delay.....	115	PLAYBACK.....	152
EQUALIZER.....	116	RECORDING A PERFORMANCE VIA USB CABLE .....	152
SECTION EQUALIZER.....	116	USING A MIDI SOUND MODULE.....	153
MASTER EQUALIZER .....	117	BASIC CONNECTIONS .....	153
RECORDING A COMBINATION OR PATCH.....	118	SIMPLIFIED SETUP MODE .....	153
EDITING CUSTOM PARAMETERS .....	119	RECORDING TO A SEQUENCER OR DAW .....	154
CUSTOM CONTENTS.....	119	USING THE MIDI PORTS.....	154
APP (APPLICATION) MENU .....	119	PLAY BACK THE PERFORMANCE.....	154
CUSTOM TONE WHEELS .....	120	USING USB MIDI.....	155
CUSTOM PEDAL REG. ....	123	MIDI FUNCTION MODE.....	156
CUSTOM LESLIE.....	124	MIDI TEMPLATE .....	156
CUSTOM PIPE .....	126	GENERAL.....	156
RECORDING A CUSTOM SETTING .....	128	SYSTEM EXCLUSIVE MESSAGES .....	157
SYSTEM.....	129	MIDI CHANNELS.....	157
SYSTEM PARAMETERS AND CONTENTS .....	129	<b>USING MEMORY .....</b>	<b>159</b>
SOUND .....	130	USING MEMORY .....	160
MASTER TUNE.....	130	WHAT YOU CAN DO WITH A USB FLASH DRIVE .....	160
MASTER TRANSPOSE .....	130	ABOUT USB FLASH DRIVES .....	160
MASTER EQUALIZER.....	130	COMPATIBLE USB FLASH DRIVES .....	160
AUDIO .....	131	USB CONNECTOR .....	160
OUTPUT .....	131	FOLDER STRUCTURE .....	160
LESLIE.....	131	FORMAT .....	161
CONTROL.....	132	USB MASS STORAGE.....	162
FOOT SWITCH 1/2.....	132	WHAT IS "USB MASS STORAGE?" .....	162
EXPRESSION PEDAL.....	133	SETTING USB MODE TO "HOST PORT" .....	162
DAMPER.....	134	USING SETUP FILES .....	163
USER.....	134	SAVE .....	164
PITCH BEND .....	135	LOAD .....	165
TONE WHEEL BRAKE .....	135	DELETE .....	166
DISPLAY .....	136	TROUBLESHOOTING.....	168
PANEL .....	136	TROUBLES .....	168
KEYBOARD .....	137	ERROR MESSAGES .....	168
PATCH LOAD .....	138	<b>APPENDIX.....</b>	<b>169</b>
FAVORITE .....	139	FACTORY COMBINATIONS .....	170
ACCESS.....	139	ORGAN PATCHES.....	171
BANK 1 - 10 .....	139	PIANO/ENSEMBLE PATCHES .....	172
DISPLAY .....	139	MONO SYNTH PATCHES .....	175
GLOBAL .....	140		
POWER.....	140		
USB .....	140		



WAVEFORM LIST.....	176
PIANO/ENSEMBLE .....	176
PIPE ORGAN STOPS & ProChord VOICING .....	177
PIPE ORGAN STOPS.....	177
MIDI TEMPLATES .....	178
MIDI TEMPLATES .....	178
MIDI INFORMATION .....	180
MIDI IMPLEMENTATION.....	180
CHANNEL VOICE MESSAGES .....	180
CHANNEL MODE MESSAGES.....	180
DRAWBAR DATA LIST .....	181
SYSTEM EXCLUSIVE MESSAGE .....	181
COMBINATION PARAMETERS .....	182
ORGAN PATCH PARAMETERS.....	184
PIANO/ENSEMBLE PATCH PARAMETERS .....	186
MONO SYNTH PATCH PARAMETERS .....	189
CUSTOM SETS .....	191
CUSTOM TONE WHEELS .....	191
CUSTOM SUB DRAWBARS .....	191
CUSTOM LESLIE CABINETS .....	191
CUSTOM PIPES.....	191
CUSTOM TONE WHEEL PARAMETERS.....	192
CUSTOM PEDAL REG. PARAMETERS .....	192
PIPE PARAMETERS.....	192
CUSTOM LESLIE PARAMETERS .....	193
SYSTEM PARAMETERS.....	194
FAVORITES.....	195
MIDI IMPLEMENTATION CHART.....	196
MIDI CHANNELS AND MESSAGES.....	197
SPECIFICATIONS.....	198
INDEX.....	199
SERVICE.....	200

All product names mentioned in this document are trademarks or registered trademarks of their respective owners.

# NAMES AND FUNCTIONS

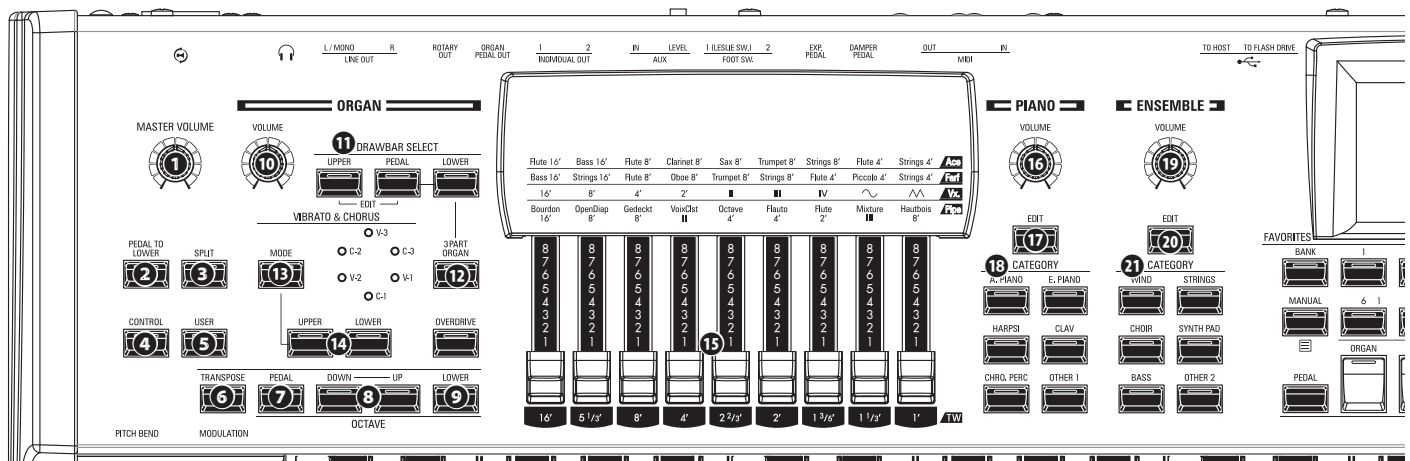

## TOP PANEL

### LEFT SIDE

- 1 MASTER VOLUME knob**  
Controls the volume of the entire instrument.
- 2 PEDAL TO LOWER button**  
Couples the entire Pedal registration, including Parameters, to the Lower Manual (P. 55).
- 3 SPLIT button**  
Divides the keyboard into Upper (right) and Lower (left) keyboards (P. 54).
- 4 CONTROL button**  
Accesses a feature from the CONTROL Menu.
- 5 USER button**  
Displays a user-assignable Menu Page.
- 6 TRANSPOSE button**  
Transposes the musical pitch of the entire keyboard when used in conjunction with **3** (P. 58).
- 7 OCTAVE PEDAL button**  
Moves the pitch of the Pedal tones “UP” or “DOWN” by octaves when used in conjunction with the [UP] or [DOWN] buttons **8**.
- 8 OCTAVE DOWN/UP buttons**  
Moves the UPPER Keyboard pitch “UP” or “DOWN” +/- 2 octaves (P. 55).
- 9 OCTAVE LOWER button**  
Moves the LOWER Keyboard pitch “UP” or “DOWN” +/- 2 octaves when used in conjunction with the [UP] or [DOWN] buttons **8**.

### ORGAN SECTION

- 10 ORGAN VOLUME knob**  
Controls the entire volume of the ORGAN Section (P. 31).
- 11 DRAWBAR SELECT buttons**
  1. Select which ORGAN Part the Harmonic Drawbars **15** will affect (P. 33).
  2. Match the Drawbar Registration contained in a Patch with the physical Drawbar setting (P. 45).
  3. Opens the editing page of the ORGAN Section ([UPPER]

and [PEDAL] buttons pressed together).

- 12 3 PART ORGAN button**  
Converts the ORGAN Section to a two-manuals-and-pedals Hammond Organ (P. 36).
- 13 VIBRATO & CHORUS MODE button**  
Selects the depth of either the Vibrato or Chorus (P. 34).
- 14 VIBRATO UPPER, LOWER button**  
Turns the Vibrato/Chorus “ON” or “OFF” for the Upper or Lower ORGAN Part (P. 34).
- 15 HARMONIC DRAWBARS**  
Registers the ORGAN Section (P. 38).
- 25 UPPER PERCUSSION buttons**  
Adds Harmonic Percussion (decay) to the UPPER Part of the ORGAN Section (P. 34).

### PIANO / ENSEMBLE SECTION

- 16 19 VOLUME knob**  
Controls the volume of the Section (P. 47).
- 17 20 EDIT button**  
Opens the Function Mode for the Section.
- 18 21 CATEGORY button**  
Selects the Voice Category of the Section (P. 46).

### ALLOCATE

- 22 PEDAL button**  
Allocates a Voice Section to the Pedalboard when used in conjunction with the PEDAL button **23** (P. 54).
- 23 SECTION buttons**  
Allocates each Voice Section to the UPPER Keyboard (P. 54).
- 24 LOWER button**  
Allocates a Voice Section to the LOWER Keyboard when used in conjunction with the LOWER button **24** (P. 54).

### FAVORITES

- 26 BANK button**  
Selects Favorite Banks by pressing and holding this button with one of the Favorite Number buttons.
- 27 MANUAL/APP button**
  1. Overrides the current Combination setting in favor of the current Panel settings (P. 29).
  2. Opens the APP (Application) Menu.

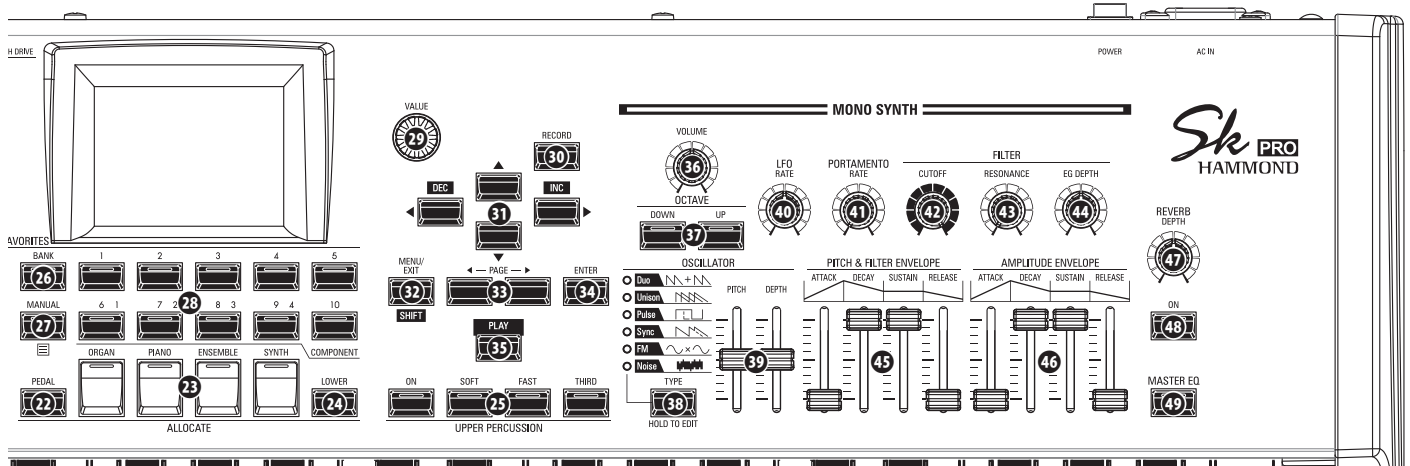

### 28 NUMBER buttons

Recalls a Favorite related to the numbered button.

## CONTROL PANEL

### 29 VALUE knob

Increases or decreases Combination/Patch numbers while performing, or adjusts values during editing.

### 30 RECORD button

Use this button to Record user-definable features such as Combinations, Patches, Custom Parameters etc (P. 60).

### 31 DIRECTION / DEC / INC buttons

1. Moves the cursor in the display.
2. Increments or decrements a value while pressing and holding the [SHIFT] button 32.

### 32 MENU / EXIT / SHIFT button

1. Opens the MENU Edit page (P. 66).
2. Exit or back one level from the current Menu Page.
3. Allows alternate functions for designated buttons.

### 33 PAGE buttons

Use these buttons to navigate the EDIT and FUNCTION Mode Pages.

### 34 ENTER button

Use this button to confirm the current entry or procedure when editing sounds or features.

### 35 PLAY button

Returns to the PLAY Mode.

## MONO SYNTH SECTION

### 36 VOLUME knob

Controls the volume of the MONO SYNTH Section (P. 49).

### 37 SYNTH OCTAVE DOWN/UP buttons

Moves the musical pitch of the MONO SYNTH Section "UP" or "DOWN" by one octave (P. 49).

### 38 OSCILLATOR TYPE button

1. Selects the Oscillator Type (P. 51).
2. Opens the MONO SYNTH Function Mode when pressed and held.

### 39 OSCILLATOR PITCH, DEPTH knob

Modifies the selected Oscillator waveform (P. 51).

### 40 LFO RATE knob

Adjusts the rate of the Low Frequency Oscillator (P. 51).

### 41 PORTAMENTO RATE knob

Adjusts the rate of the Portamento feature (P. 51).

### 42 FILTER CUTOFF knob

Selects the frequency at which the filter begins to have an effect on the waveform's frequency components (P. 51).

### 43 FILTER RESONANCE knob

Emphasizes the portion of the sound in the region of the cutoff frequency.(P. 51).

### 44 FILTER EG DEPTH knob

Adjusts the depth of the filter envelope 45 (P. 51).

### 45 PITCH & FILTER ENVELOPE sliders

Adjusts the changing over time of the pitch and filter (P. 51).

### 46 AMPLITUDE ENVELOPE sliders

Adjusts the changing over time of the amplitude or volume (P. 51).

## RIGHT SIDE

### 47 REVERB DEPTH knob

Adjusts the depth of the Reverb effect (P. 56).

### 48 REVERB ON button

Turns the Reverb "ON" or "OFF" (P. 56).

### 49 MASTER EQ button

Turns the Master Equalizer. "ON" or "OFF" (P. 56).

## LEFT SIDE OF THE KEYBOARD

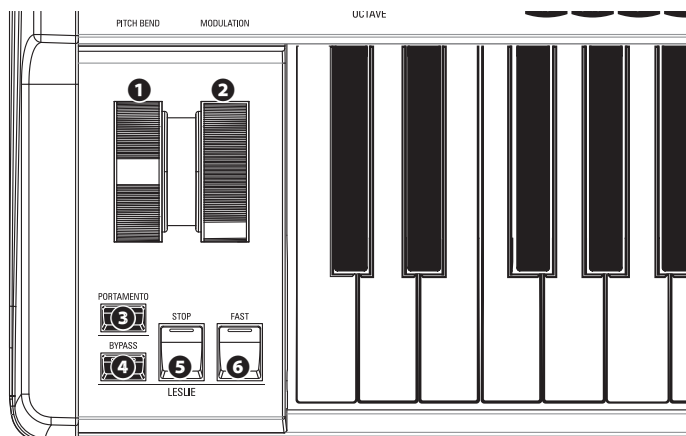

### WHEELS

**1 PITCH BEND wheel**

Bends the pitch of played notes “UP” or “DOWN” (P. 28).

**2 MODULATION wheel**

Applies modulation to played notes (except ORGAN Section) (P. 28).

### PORTAMENTO

**3 PORTAMENTO button**

Turns the PORTAMENTO “ON” or “OFF” (P. 28).

### LESLIE

**23 LESLIE BYPASS button**

Channels the sounds produced by the ORGAN Section from the Rotary channel to the Stationary channel (P. 35).

**24 LESLIE STOP button**

Stops the Leslie Rotors from turning when the [FAST] button is OFF” (P. 35).

**25 LESLIE FAST button**

Selects “FAST” Leslie Rotor speed (P. 35).

## REAR PANEL

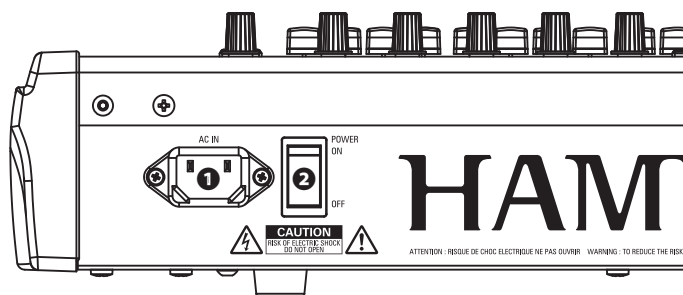

### POWER

**1 AC POWER RECEPTACLE**

Connect the female end of a grounded AC Power Cord here, and the male end into a grounded AC power outlet.

**2 POWER switch**

Turns the AC power to the instrument “ON” or “OFF”

### AUDIO OUTPUT JACKS

**3 PHONES jack**

Use this jack to connect a set of stereo headphones.

**NOTE: Connecting Headphones does NOT mute the LINE OUT or LESLIE audio outputs. If you wish the sound to go through the Headphones only, disconnect all other audio outputs.**

**4 LINE OUT L/MONO jack**

**LINE OUT R jack**

Use these jacks to connect external audio equipment.

If the connected mixer or monitor speaker is stereophonic, connect both the L and R jacks. If it is monaural, connect only to the L/MONO jack.

**5 Leslie® LESLIE 11 -PIN socket**

Use to connect a Leslie Speaker Cabinet having an 11-pin interface.

When a Leslie Speaker Cabinet is detected at via the 11-pin socket, the inbuilt digital Leslie is disabled at the PHONES jack and the LINE OUT jacks (P. 17).

**6 ROTARY OUT jack**

Outputs the Rotary Channel of the ORGAN Section. Use this jack to bypass the inbuilt digital Leslie if you want a “dry” audio output from the ORGAN Section.

**NOTE: Set the “ROTARY OUT” switch in the AUDIO portion of the FUNCTION Mode “Used” if you use this jack (P. 18).**

**7 ORGAN PEDAL OUT jack**

Outputs the PEDAL Part of the ORGAN Section. Use this jack to connect a powered sub-woofer to increase the bass, or to bypass the Leslie to the PEDAL Part (P. 18).

**8 INDIVIDUAL OUT 1 jack**

**INDIVIDUAL OUT 2 jack**

Outputs the specified Section independently (P. 19).

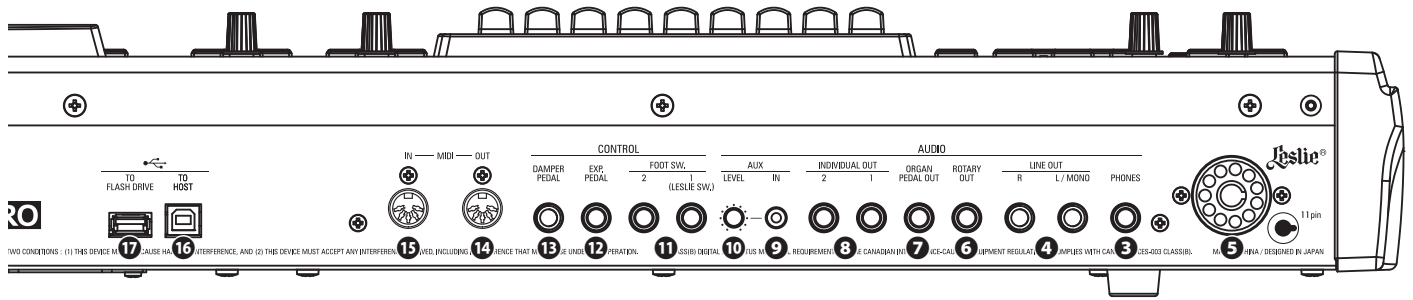

## AUDIO INPUT JACK

### 9 AUX IN jack

Use this jack to connect an external audio source. When connected, the sound will be mixed with the internal keyboard sounds and sent out to the LINE OUT jacks and the Stationary channel of a multi-channel Leslie Speaker via the 11-pin socket (P. 19).

### 10 AUX LEVEL knob

Adjusts the volume of the sound coming in from the AUX IN jack.

## CONTROLLER JACKS

### 11 FOOT SWITCH 1 jack

#### FOOT SWITCH 2 jack

Use these jacks to connect Foot Switches to switch the Leslie or change Combinations.

The recommended Foot Switches are listed below;

**HAMMOND**... FS-9H, VFP1

**BOSS**..... FS-5U

**YAMAHA**..... FC4A, FC5

In addition, the FS-10TL Leslie Switch (not available in Europe) can be connected to the FOOT SWITCH 1 jack.

### 12 EXP PEDAL jack

Use this jack to connect an Expression Pedal to control volume while playing.

The recommended Expression Pedals are listed below:

**HAMMOND**... EXP-50J, EXP-20, V-20H, V-20R; NORM

**KORG**..... XVP-10, XVP-20; REV

**ROLAND**..... EV-5; NORM

**YAMAHA**..... FC7; REV

### 13 DAMPER PEDAL jack

Use this jack to connect a Damper Pedal (Sustain Pedal) for holding notes when keys are played and released.

The recommended Damper Pedals are listed below:

**HAMMOND**... FS-9H, VFP1

**ROLAND**..... DP-10

**YAMAHA**..... FC3A, FC4A, FC5

## MIDI PORTS

### 14 MIDI OUT Port

Transmits MIDI data to a connected MIDI device.

### 15 MIDI IN Port

Receives MIDI data from a connected MIDI device. This port can be programmed for a LOWER Keyboard or a Pedalboard.

## USB PORTS

### 16 USB TO HOST Port

Use to connect to a computer to transmit MIDI messages or Load and Save files such as Setups or Update files.

### 17 USB FLASH DRIVE Port

Use to connect a USB Flash Drive to Load or Save files such as Setup or Update files.

## KEYBOARD

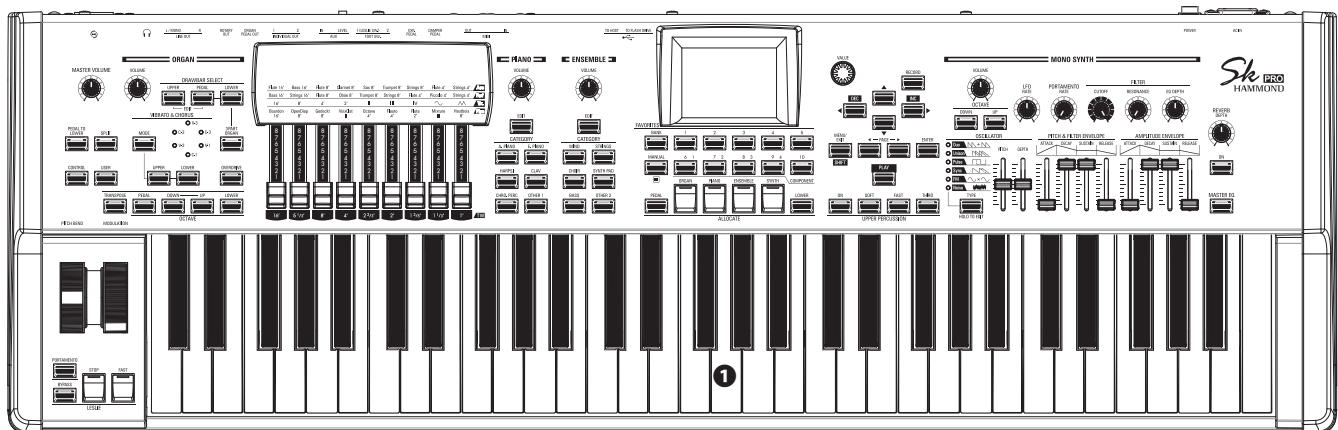

**1 Keyboard**

61 notes (SK PRO) / 73 notes (SK PRO-73), square-front (“waterfall” type), semi-weighted, velocity-sensitive keyboard.

## ACCESSORY

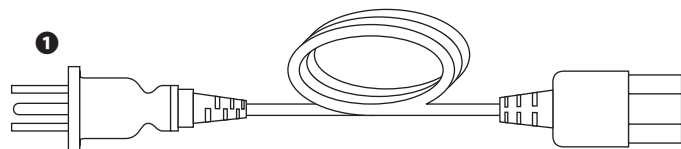

**1 AC Power Cord**

Connects to the AC Power Receptacle of the SK PRO/SK PRO-73.

## ACCESSORIES (SOLD SEPARATELY)

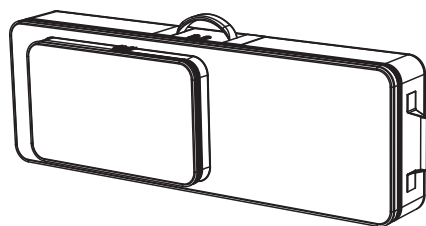

**Soft Case (SC-61KC, SC-73KC)**

Light-weight carrying case, can be held with both hands or put over the shoulder. Additional pocket for storing music, Foot Switches, Expression Pedal, etc.

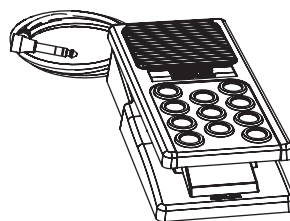

**Expression Pedal EXP-20**

Light weight for touring usage.

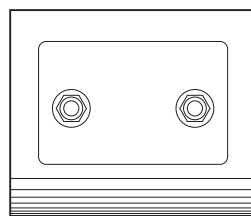

**Leslie Switch FS-10TL  
(not available in Europe)**

Controls both the [ON/OFF] and [SLOW/FAST] of the Leslie Rotors.

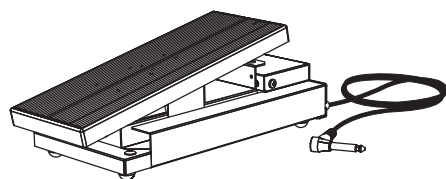

**Expression Pedal EXP-50J**

Heavyweight pedal for durability, and detachable cable to avoid breaking or fraying.

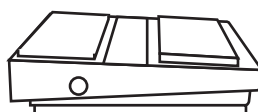

**Foot Switch FS-9H**

Multi-purpose foot switch with Momentary action.



**MAKING THE  
CONNECTIONS**

---

# BASIC CONNECTIONS

Connect audio cables and accessories as shown below.

The SK PRO/SK PRO-73 is not self-contained - an external amplifier/speaker system is required in order to hear the sound. However, if you connect a set of stereo headphones to the PHONES jack, you can hear the sound through the headphones even if an external amplifier is not connected.

**NOTE: Be sure that both the instrument and amplifier are "OFF" before connecting amplifiers or headphones.**

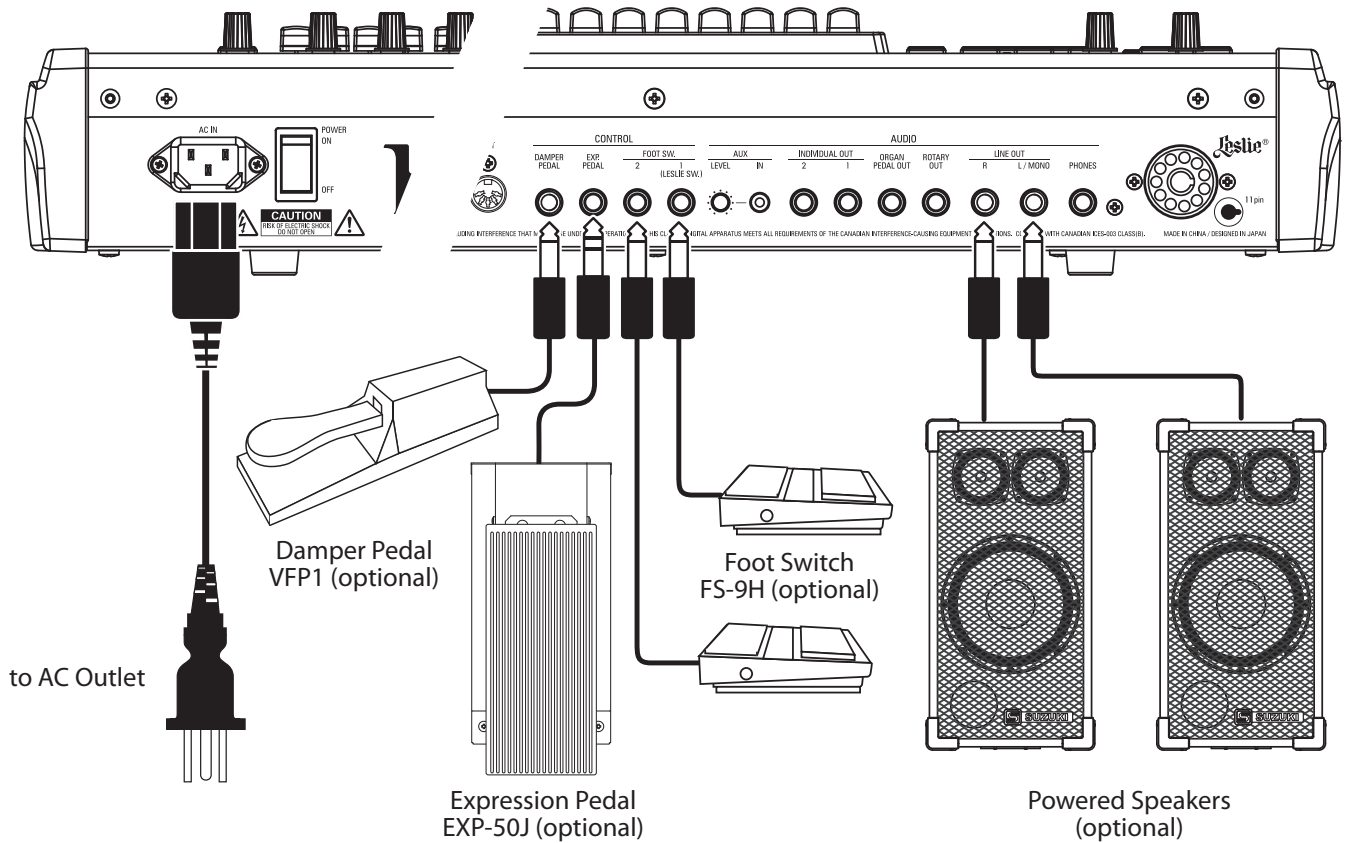

**NOTE: The Expression Pedal, Foot Switch and Damper Pedal Parameters must be set properly. This is explained in more detail starting on page 132.**

## ⚠ CAUTION

This instrument draws a slight amount of power even if the [POWER] switch is "OFF." Therefore, if the instrument will not be used for a long period of time, disconnect the AC plug from the outlet.

Do not place this instrument in direct sun light, near heat sources, or in a hot location.



A Leslie Speaker Cabinet with an 11-pin interface can be directly connected to the SK PRO/SK PRO-73.

**NOTE:** Be sure the power to the SK PRO is "OFF" before connecting the Leslie Speaker.

## Connecting a single-channel Leslie Speaker

## Connecting a 3-channel Leslie Speaker

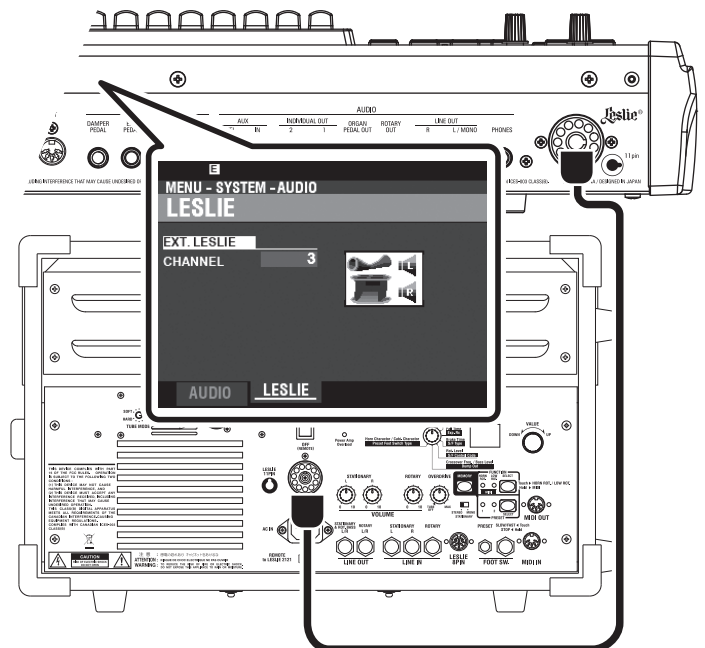
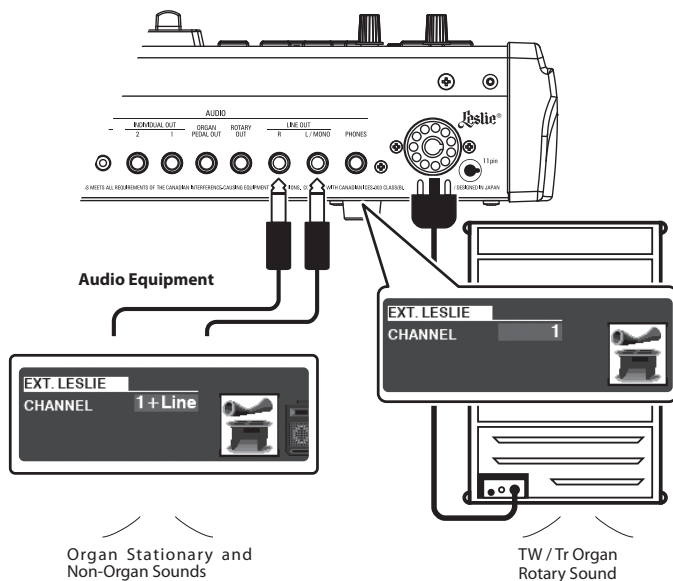

## BASIC CONNECTION

### 3-CHANNEL TYPE (2101/mk2)

1. Connect the SK PRO to the Leslie Speaker via an 11-pin Leslie cable (optional LC-11-7M, not included).
2. Turn the power to the SK PRO "ON" and set the EXT. LESLIE CH Parameter to "3."
3. Make sure a Hammond Tone Wheel Organ (**A-100**, **B-3**, **C-3**, or **Mellow**) is selected.
4. Press the [BYPASS] button "ON" and set the [STATIONARY VOLUME] of the Leslie Speaker at a desired level.
5. Press the [BYPASS] button "OFF" while playing, and set the [ROTARY VOLUME] of the Leslie Speaker at the same audible level as the [STATIONARY] Channel.

### SINGLE-CHANNEL TYPE (122XB, 981, 3300/W)

1. Connect the SK PRO to the Leslie Speaker via an 11-pin Leslie cable (optional LC-11-7M, not included). This will allow you to hear the Drawbar ORGAN sounds.
2. Connect the SK PRO to a keyboard amp or powered speakers via 1/4" audio cables from the LINE OUT jacks of the SK PRO.
3. Turn the power to the SK PRO "ON" and set the EXT. LESLIE CH Parameter at "1+LINE."
4. Make sure a Tone Wheel Organ (**A-100**, **B-3**, **C-3**, or **Mellow**) is selected.
5. Press the [BYPASS] button "ON" and set the audio equipment at a desired level.
6. Press the [BYPASS] button "OFF" and set the Volume of the connected Leslie Speaker at the same audible level as when the [BYPASS] button is "OFF."

### tips LESLIE SPEAKERS TO CONNECT

The SK PRO/SK PRO-73 is designed to connect with 3-channel Leslie Speakers such as the 2101/mk2. It is also possible to connect a single-channel Leslie Speaker such as a 122XB, 981 or 3300/W; however, a single-channel Leslie will reproduce the Drawbar ORGAN sounds only. To hear the PIANO/ ENSEMBLE/SYNTH voices, connect an additional sound source such as a keyboard amp or powered speakers via the LINE OUT jacks.

### tips LESLIE CHANNEL

3-channel type Leslie Speakers are equipped with a stereo speaker system, independent of the Rotary channel, to provide stereo sound for the Rotary (ORGAN) channel and the Stationary (PIANO, ENSEMBLE and MONO SYNTH) channel.

A traditional single-channel Leslie Speaker, such as a 122, 981 or 3300/W has no stationary speaker system, thus requiring a separate amplifier/speaker for other sounds such as PIANO, ENSEMBLE and MONO SYNTH.

# OTHER AUDIO CONNECTIONS

## OUTPUT DRY ORGAN SOUNDS

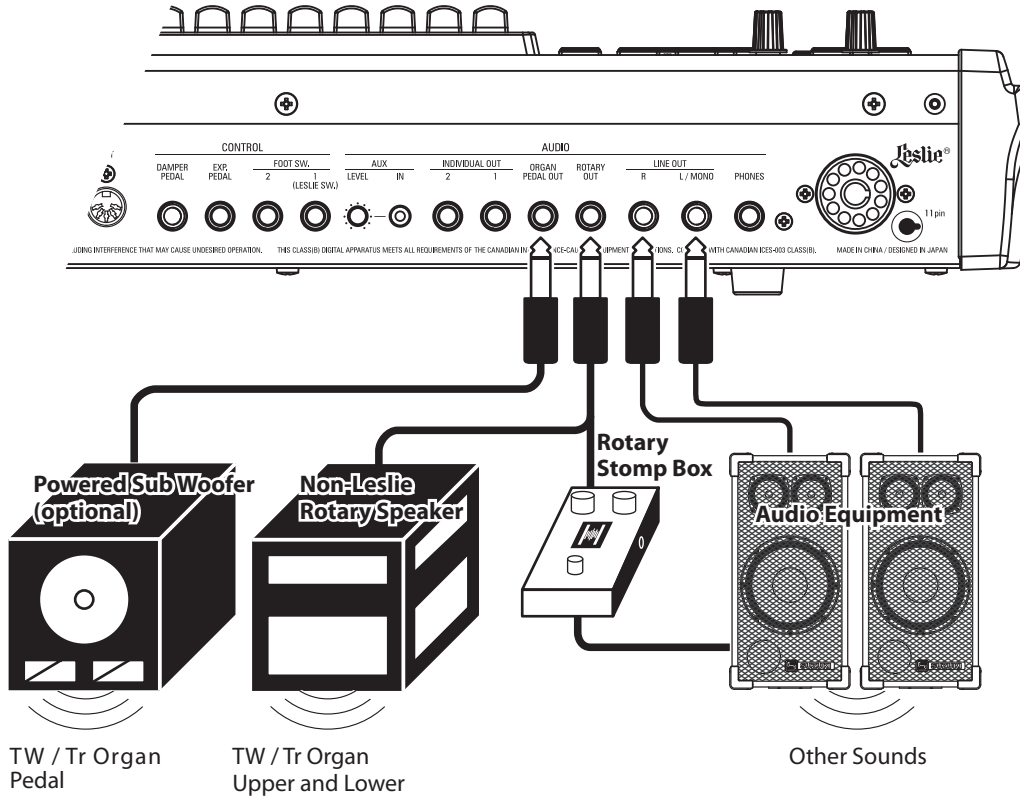

### ROTARY OUT jack

Use the [ROTARY OUT] jack if you want to output a “dry” organ signal without the inbuilt digital Leslie.

**NOTE:** Set the “ROTARY OUT” switch in the AUDIO FUNCTION Mode at “Used” when using this jack to mute the ORGAN Section from the [LINE OUT] jacks. This is explained in more detail on page 131.

### ORGAN PEDAL OUT jack

This jack outputs the PEDAL Part of the ORGAN Section.

Connect the [ORGAN PEDAL OUT] jack to a powered sub-woofer if you want to reinforce the bass or bypass the Leslie to the PEDAL Part.

**NOTE:** Set the “USE PEDAL OUT” switch in the AUDIO FUNCTION Mode at “Used” when using this jack to mute the PEDAL Part from the [LINE OUT] jacks.

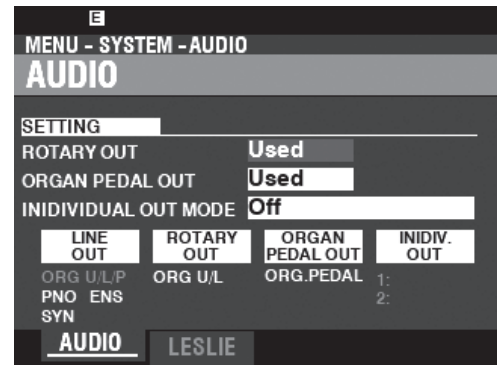

## USING AN EXTERNAL MIXER

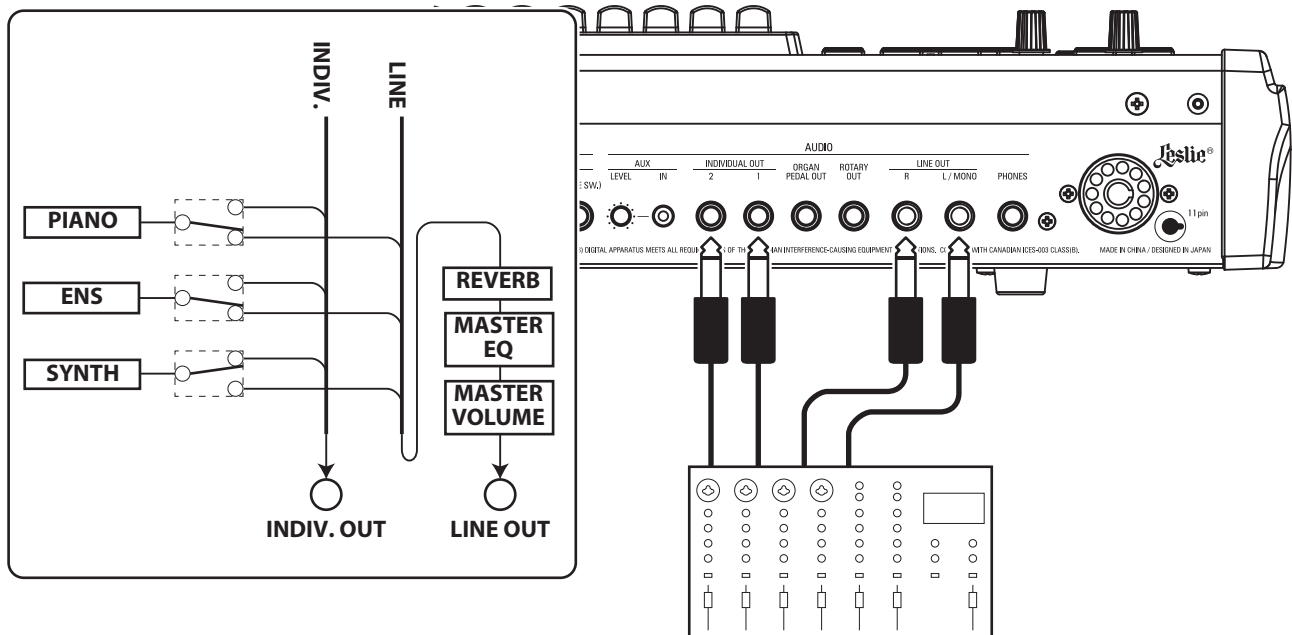

### INDIVIDUAL OUT jacks

Use the [INDIVIDUAL OUT] jacks to connect an external mixer or add effects from external effects devices. You can choose the Voice Section which will be present at each of these jacks.

**NOTE:** Use the **INDIVIDUAL OUT** switch in the **AUDIO FUNCTION** Mode to select the Sections to assign to the [INDIVIDUAL OUT] jacks. This is explained in more detail on page 131.

**NOTE:** If a Voice Section is assigned to an [INDIVIDUAL OUT] jack, it will not be muted from the [LINE OUT] jacks.

**NOTE:** The sound from the [INDIVIDUAL OUT] jacks is not affected by Reverb, the Master Equalizer, or the [MASTER VOLUME] knob.

**NOTE:** The **ORGAN** Section cannot be assigned to the INDIVIDUAL OUT jacks.

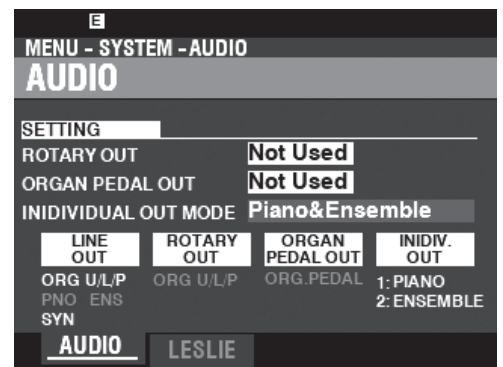

## USING A MUSIC PLAYER

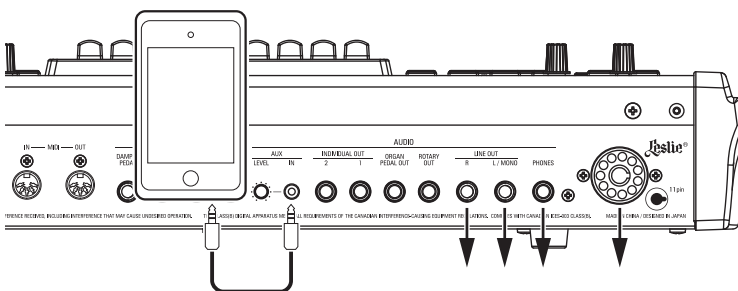

### AUX IN jack

Use the [AUX IN] jack to connect a music player or phone.

Use the [AUX LEVEL] knob on the Rear Panel to control the volume of a device connected via the [AUX IN] jack.

The audio signal via the [AUX IN] jack will combine with the output from the [LINE OUT] jacks, [PHONES] jack and the Stationary Channel of the 11-pin Leslie socket.

**NOTE:** The [MASTER VOLUME] knob does not affect the audio signal coming into the [AUX IN] jack.

The SK PRO/SK PRO-73 can be expanded by connecting an external keyboard and/or a pedalboard.

## DUAL MANUAL OPERATION

You can use an external MIDI keyboard with the SK PRO in two ways (shown below):

- Use the SK PRO and an external MIDI keyboard for UPPER and LOWER Keyboards without using SPLIT.
- Play a specified Section, such as PIANO, via external MIDI keyboard while retaining a SPLIT on the SK PRO.

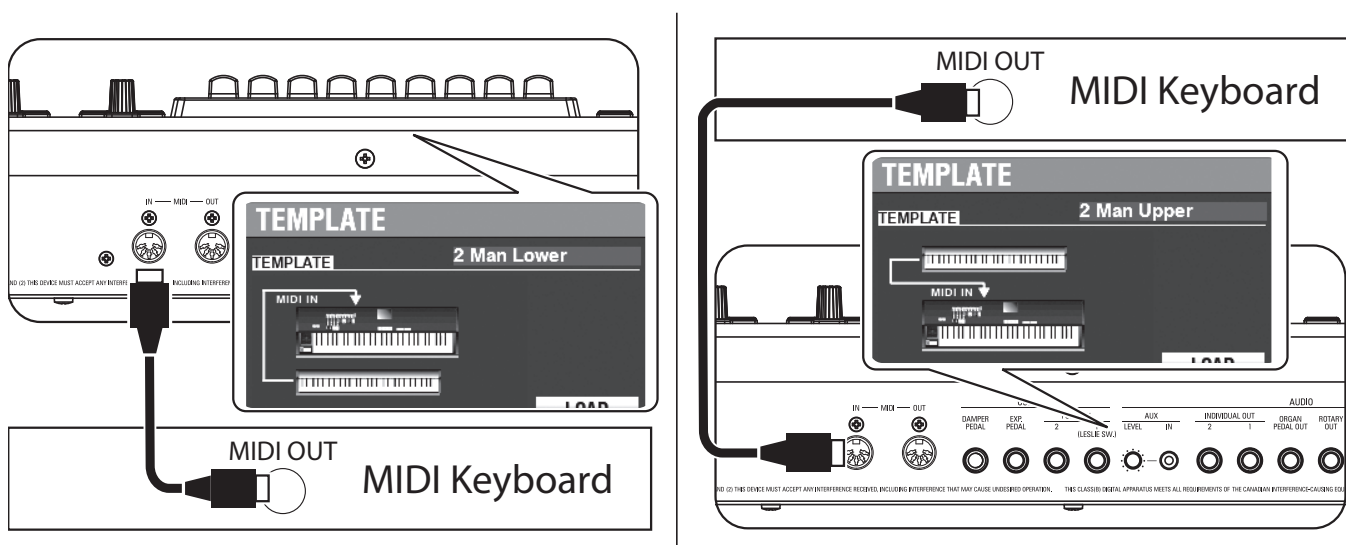

In order to use an external MIDI keyboard, you will have to connect it via MIDI. You will also have to select a **MIDI Template**, which is a preselected set of MIDI Parameters designed for specific MIDI applications.

To use an external MIDI keyboard with the SK PRO, do the following:

1. Connect an external MIDI keyboard as shown above.
2. Turn the power to the SK PRO "ON" and press the MENU\EXIT button to enter MENU Mode.
3. Press the [PAGE ►] button two times to display the SYSTEM Menu.
4. Press the [DIRECTION ►] button once to select MIDI.
5. Press the [ENTER] button. You will see the MIDI TEMPLATE Menu.
6. Use the [VALUE] knob to select the MIDI Template for the type of playing you want to do.

**2 Man Lower** ..... The internal keyboard works as Upper, and the MIDI keyboard works as Lower.

**Piano** ..... The internal keyboard works as Upper and Lower, the MIDI keyboard sounds PIANO Section only.

For more specific information about the connected MIDI keyboard, please refer to the Owner's Manual for the specific keyboard you are using.

## TWO MANUALS + PEDALBOARD

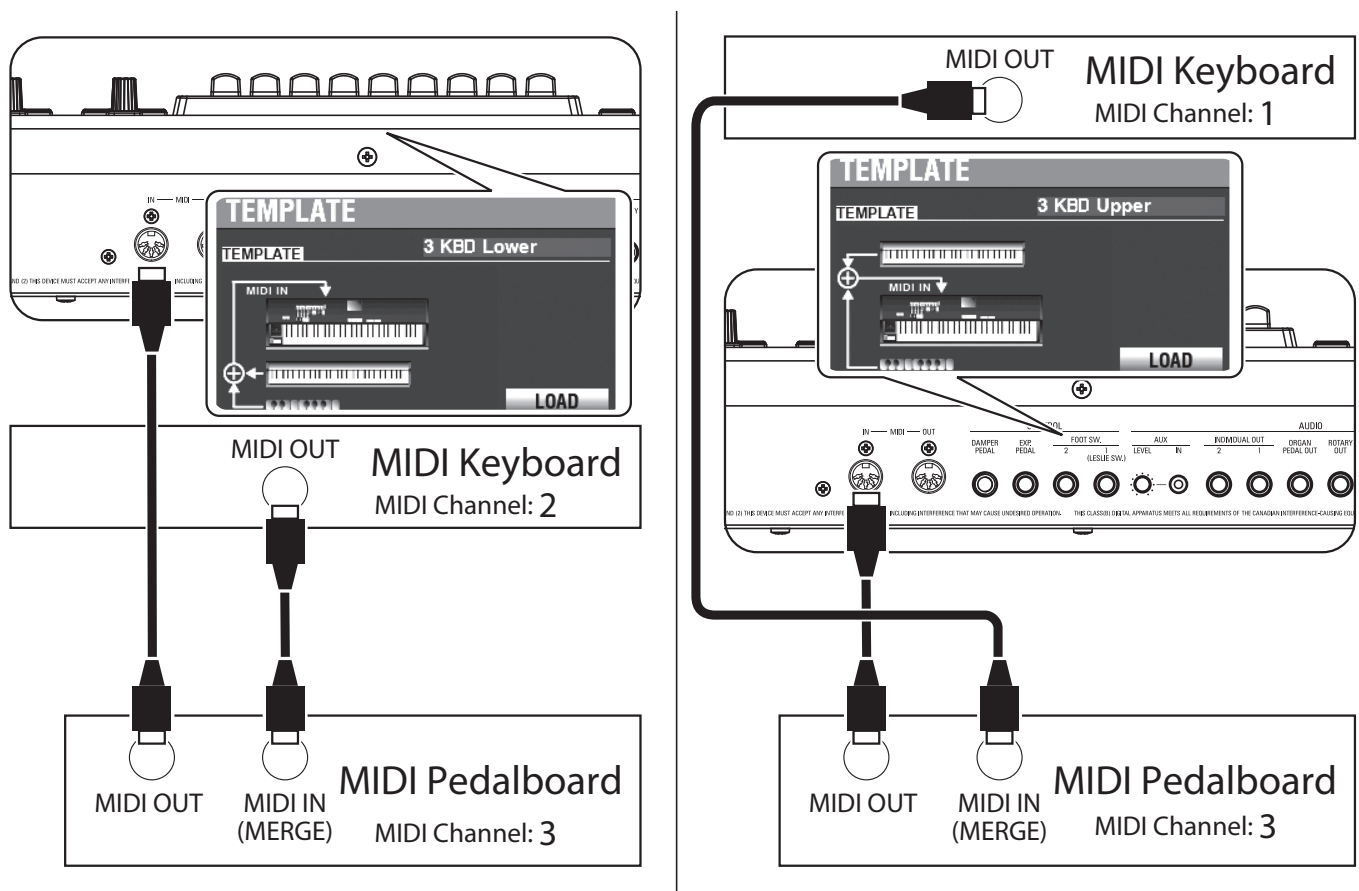

1. Connect as illustrated above. The SK PRO has one MIDI IN Port; therefore a MIDI keyboard with a merge function or a MIDI Merge-box is necessary for a dual keyboard configuration.
2. Turn the power to the SK PRO/SK PRO-73 "ON."
3. Select MIDI Template "3KBD Upper" or "3KBD Lower."
4. Set the Transmit channel of the added MIDI keyboard at "2" if you are using it as a Lower Keyboard, or "1" if you are using it as a UPPER Keyboard. If you are using a MIDI Pedalboard, set its Transmit Channel at "3."

**NOTE:** Hammond MIDI Pedalboards are automatically set to transmit on MIDI Channel 3.

## RECOMMENDED MIDI PEDALBOARDS

The following HAMMOND MIDI Pedalboards are recommended for use with the SK PRO/SK PRO-73:

- MIDI Sound Pedalboard XPK-130G (13 notes)
- MIDI Sound Pedalboard XPK-200G (20 notes)
- MIDI Sound Pedalboard XPK-200GL (long 20 notes)

**NOTE:** The SK PRO/SK PRO-73 can also be used with the following Hammond MIDI Pedalboard models:

**XPK-100, XPK-200, XPK-200L.**

### **tips** HOW A MIDI KEYBOARD WORKS

On the SK PRO, a connected MIDI keyboard functions as a "LOWER" Keyboard when the MIDI Template is set for "3KBD" or "Two Manual." On the SK PRO-73, a connected MIDI keyboard functions as an "UPPER" keyboard when the MIDI Template is set for "3KBD" or "Two Manual."

---

**\*\*\*THIS PAGE INTENTIONALLY LEFT BLANK TO PRESERVE PAGE FORMATTING \*\*\***



# POWERING ON

After making the connections described on the previous pages, you are ready to turn the SK PRO power “ON.” Follow the procedure below to prevent malfunction or damage.

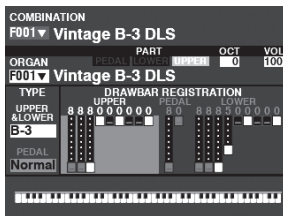
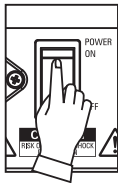
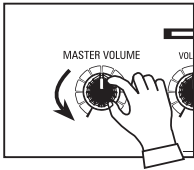

## TURNING THE POWER “ON”

1. Before turning the power to the SK PRO “ON,” make sure you have connected all peripherals (Expression Pedal, Foot Switch(es), etc.) properly. Also be sure to set the [MASTER VOLUME] knob to its minimum setting.

**NOTE: The polarity of each Foot Controller will be detected automatically.**

2. The Power Switch is located on the left side of the Accessory Panel (right side facing the keyboard). Turn the power to the instrument “ON.” The display will show, “Loading...” below the opening screen for approximately 25 seconds while the system software loads, then the PLAY Mode screen will display.

**NOTE: If you have a Leslie Speaker connected to the instrument, the Leslie will turn “ON” automatically.**

**NOTE: In order to protect the circuits, the SK PRO will be ready to play approximately 6 seconds after the power is turned “ON.”**

3. Turn the power to the connected amplifier “ON.”

4. Hold down a playing key and turn the [MASTER VOLUME] to the right a little and play some notes on the keyboard. Adjust the [MASTER VOLUME] as needed.

**NOTE: If the [MANUAL] button is pressed in the Default setting and the [ALLOCATE] buttons are all “OFF,” no sound will be heard. You can touch any of the [ALLOCATE] buttons or select any of the [FAVORITE] ([1] to [10]) buttons to hear sounds.**

5. Adjust the volume of the amplifier.

**NOTE: To turn the SK PRO power “OFF,” reverse the above procedure. Also, be sure to turn the power to a connected amplifier “OFF” before turning the keyboard “OFF.” This will prevent a loud “pop” from the amplifier.**

## BACKING UP THE INITIAL SETTINGS

The SK PRO does not remember the status of the playing controls before the power is turned “OFF.” The status of the default settings are the same as when the [FAVORITE] [1] button is depressed.

## AUTO POWER OFF

The SK PRO has an “AUTO POWER OFF” feature which will automatically turn the power to the instrument “OFF” if no keys or buttons are pressed for 30 minutes.

**NOTE: Depending on the status of the instrument - while editing, for example - the power may not turn “OFF” even if AUTO POWER OFF is enabled. Therefore, it is best to turn the SK PRO power “OFF” via the Power Switch after every use.**

## RESTORING THE FACTORY SETTINGS

To reset all Parameters of the SK PRO to their default settings, do the following:

1. Turn the power to the SK PRO “OFF.”
2. Press and Hold the red [RECORD] button.
3. While holding the red [RECORD] button, turn the [POWER] “ON.”
3. Continue to hold down the red [RECORD] button. When “Loading Default” is displayed, release the red [RECORD] button.
4. When the PLAY Mode is displayed, the factory settings have been restored.



The illustration below show the structure of the sound engine and memory.

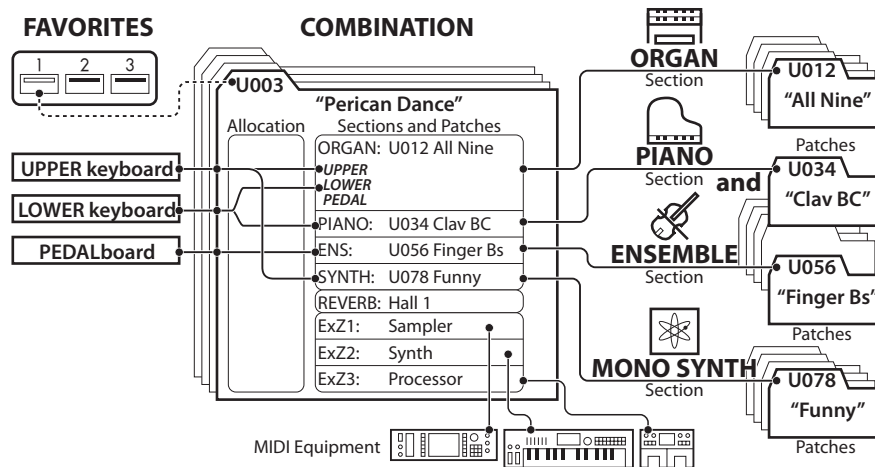

The SK PRO has four sound-producing divisions or **Sections**. Each Section has sounds and Parameters which can be Recorded as a Patch. In addition, Patches from the different Sections can be combined to produce a Combination. This is explained in more detail starting below.

## SECTIONS



There are four (4) sound Sections - ORGAN, PIANO, ENSEMBLE and MONO SYNTH. These can be used individually or together, as shown on the right side of the above illustration.

## KEYBOARDS AND PARTS

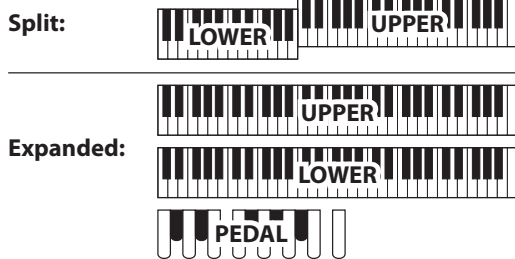

The SK PRO Voice Sections can be allocated either by using the SPLIT feature to divide the keyboard or by expanding the instrument via MIDI (see the figure above). When the [SPLIT] feature is enabled, the portion of the keyboard to the right of the SPLIT Point is called UPPER and the left portion of the keyboard is called LOWER. PEDAL refers to the bass tones which can be played from a connected MIDI Pedalboard.

## PARTS

The ORGAN Section has 3 Parts - UPPER, LOWER and PEDAL. These can be assigned either by using the [ALLOCATE] buttons or, when using the [3 PART ORGAN] function, allocated to replicate the performance of a classic Hammond Organ with two manuals and pedals.

## MEMORY

### PATCHES

A **Patch** is an individual unit of each Voice Section. For example, the PIANO Section contains Grand Pianos, Electric Pianos, etc., the ENSEMBLE Section contains Strings, Choir, and so on.

### FACTORY, USER and BUNDLE

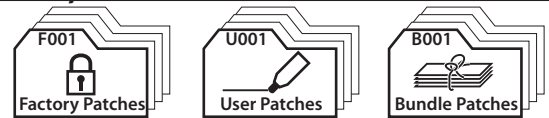

The Patches are grouped in three ways. “F” (Factory) Patches are set at the factory and cannot be changed. “U” (User) Patches can be changed by the player. “B” (Bundles) consist of COMBINATION Parameters plus ORGAN and MONO SYNTH Sections grouped together for inclusion into new Patches.

There are 100 Factory and 100 User Patches for the ORGAN and MONO SYNTH Sections. The PIANO and ENSEMBLE Sections share a common library of Factory and User Patches.

### COMBINATIONS

A “Combination” is a unit which contains Patches as well as other Parameters such as the Patch number of each Section, keyboard allocations of each Section, etc. (upper center illustration on this page).

The SK PRO contains a total of 100 Factory (“F”) Combinations which can be used “as is” or changed to suit the player.

For example, “ORGAN Section Patch #10, allocated to LOWER Keyboard, soft Volume, Octave +1, PIANO Section Patch #3, allocated to UPPER Keyboard at high Volume.”

### FAVORITES

The [FAVORITE] buttons allows you to store and recall frequently-used Combinations (upper figure of this page, upper-left side).

There are 10 [FAVORITE] buttons. In addition, there are 10 Banks of Favorites, bring the total number of Favorites to 100. Use the [BANK] button to access the Favorite Banks.

# USING COMBINATIONS

**Combinations** are the basic memory units of the SK PRO. This is explained in more detail starting below.

## WHAT IS A “COMBINATION?”

As explained previously, the SK PRO has four sound-producing sections - ORGAN, PIANO, ENSEMBLE, and MONO SYNTH. These, along with other Parameters such as Control Panel settings, etc., can be combined into a single unit called a **Combination**.

The SK PRO/SK PRO-73 comes with 100 pre-programmed Combinations. Starting below is an example of how to use Combinations.

**tips** WHAT IS A “BUNDLE?”

In order to decrease the number of steps necessary to create a Combination, you can save Combination Parameters, ORGAN Patches and MONO SYNTH Patches to a **Bundle**. You can then save the Bundle along with PIANO and/or ENSEMBLE Patches to a Combination.

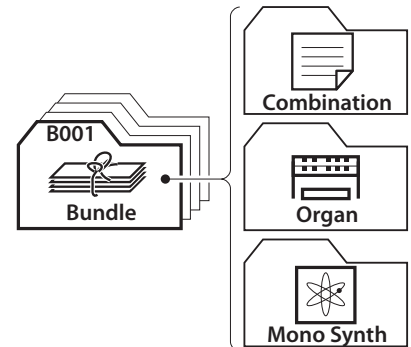

## SELECT A COMBINATION

### ① LOCATE THE PLAY MODE

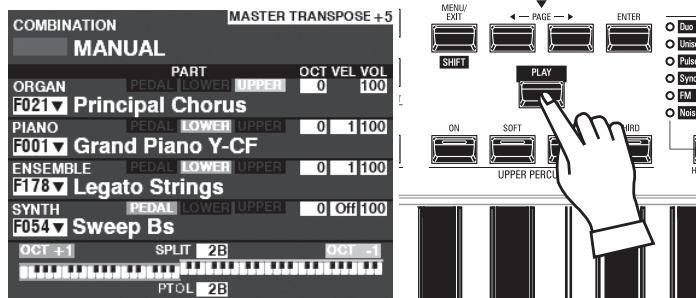

If the PLAY Mode is not displaying, press the [PLAY] button to display it.

**NOTE:** The word “MANUAL” is explained in more detail on page 29.

### ② MOVE THE CURSOR TO THE COMBINATION NUMBER

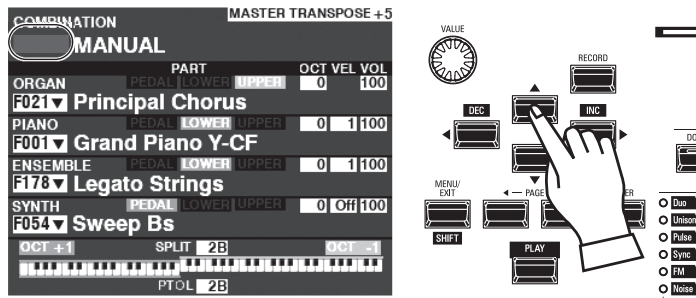

If the cursor is not at the Combination Number (very top of the screen), move the cursor to it using the [DIRECTION] buttons.

### ③ SELECT A COMBINATION

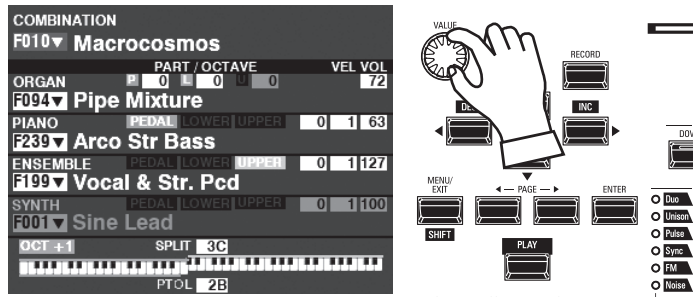

Use the [VALUE] knob to select a Combination.

**NOTE:** You can also select a Combination Number by direct numerical key input. This is explained in more detail on page 139.

**tips** “▼” INDICATES A LIST

The “▼” shown to the right side of the Combination Number indicates a list of available choices for that selected Voice Category. Use the “▲” and “▼” buttons to highlight the available Voices. When you have selected the Voice you want, press the [ENTER] button to select it. Use the [VALUE] knob to select a Combination Number and press the [ENTER] button. The Voice has now been Recorded to the Combination and the list will close.

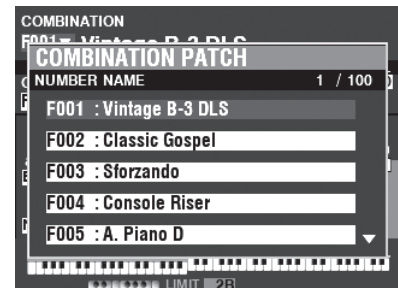

To recall Combinations that are frequently used, follow the instructions below.

## WHAT IS A "FAVORITE?"

A **Favorite** is simply a Combination which is stored to one of the 10 numbered buttons in the [FAVORITE]S section, allowing you to recall frequently used Combinations more quickly than using the [VALUE] knob.

## BANK AND NUMBER

Number	1	2	3
1	U011 Born Verse	U012 Born Solo	U011 Born Verse
2	U024 MyLife Pf	U045 Lucy Org	U023 GetBack EP
3	P061 Classic	P062 Slow	P063 Contemp.

There are 10 available Banks of Favorites, each of which contains 10 Favorites. This allows you to have 100 Combinations readily available to quick access. The chart above shows an example of compiling a **Set List** using different Favorite Banks.

## LINKING A COMBINATION TO A FAVORITE

### 1 SELECT A COMBINATION

Select a Combination you want to link to a Favorite.

For this example, link Combination F002 to Favorite #2, Bank #5.

### 2 SELECT A BANK

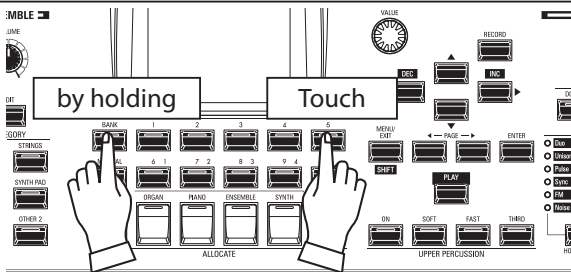

Select the Bank. For this example, select Bank 5.

Press and Hold the [BANK] button and press the [5] [FAVORITE] button. The LED of the selected number will flash several times.

### 3 SELECT A NUMBERED [FAVORITE] BUTTON

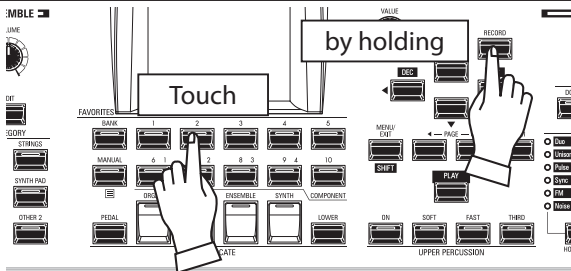

Select a Favorite Number. For this example, Press and Hold the red [RECORD] button and press the [FAVORITE] [2] button. The LED of the numbered button will flash several times. When the LED stops flashing the procedure is complete and your Bank is selected.

## RECALLING A COMBINATION USING A [FAVORITE] BUTTON

### 1 SELECT THE BANK

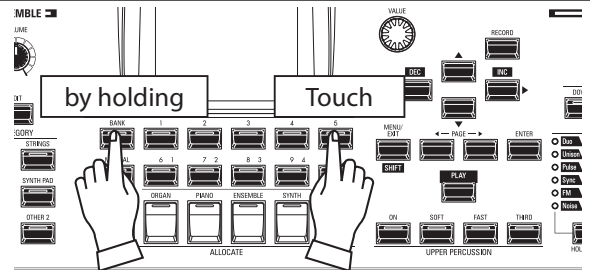

Press and Hold the [BANK] button and press the numbered [FAVORITE] button representing the Bank where the Combination you want to stored. The LED of the [FAVORITE] button will flash several times.

### 2 SELECT THE [FAVORITE] BUTTON

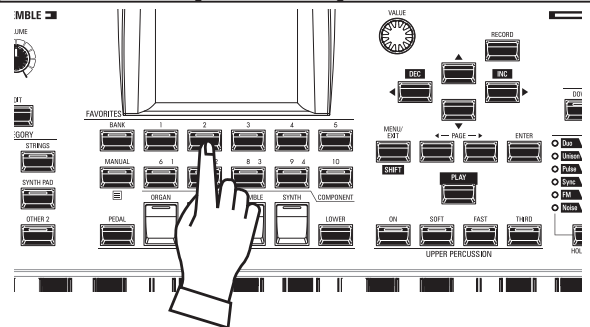

Press the numbered [FAVORITE] button where the Combination you want is stored. The LED of the numbered button will light and your Combination is selected.

**NOTE:** You can view a list of Favorites. This is explained in more detail on page 139.

#### **tips** CONFIRM THE CURRENT BANK

Press and Hold the [BANK] button to determine which Bank is selected. One of the numbered [FAVORITE] buttons will light indicating which Bank is currently active.

#### **tips** OMITTING BANK STEP

If the current Bank already contains the [FAVORITE] you want, you can omit Step 1 above.

# USING CONTROLLERS

The various Controllers of the SK PRO are explained in detail starting below.

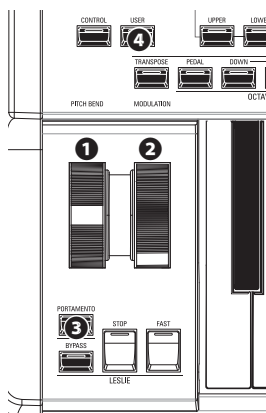

## INTERNAL CONTROLLERS

### 1 PITCH BEND wheel

This allows you to bend the pitch “UP” or “DOWN” smoothly. Push the wheel away from you to bend the pitch “UP,” and pull it toward you to bend the pitch “DOWN.” When the wheel is released, it will automatically return to its center position.

### 2 MODULATION wheel

This allows you to add Vibrato or Modulation to the sound. Push the wheel away from you to increase the effect, and away from you to decrease the effect.

**NOTE: The effects controlled by the wheels may be somewhat different for each Combination or Patch.**

### 3 PORTAMENTO button

This allows you to turn the Portamento effect “ON” or “OFF.” When this button is “ON” and Portamento is enabled for a particular Patch, the pitch will glide smoothly from the last note played to the current note being played and held.

**NOTE: The status of the PORTAMENTO button can be Recorded to a Combination.**

**NOTE: PORTAMENTO can be applied to the PIANO, ENSEMBLE or MONO SYNTH Voices. This is explained in more detail on page 91 and 101.**

### 4 USER button

This allows you to assign a function for instant access.

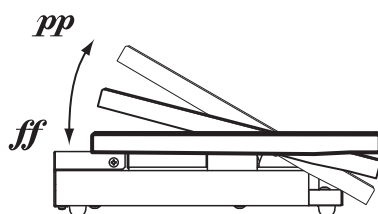

EXP-50J (optional)

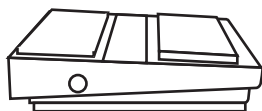

FS-9H (optional)

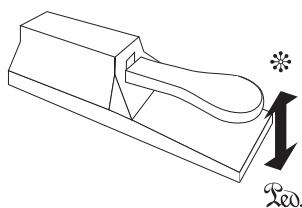

VFP1 (optional)

## EXPRESSION PEDAL

You can use an Expression Pedal to control the overall volume of the SK PRO.

Press forward with the front of your foot to increase the volume and back with your heel to decrease the volume.

**NOTE: You can adjust the minimum volume of the Expression Pedal. This is explained in more detail on page 76.**

**NOTE: You can select whether or not the Expression Pedal will affect a particular Voice Section. This is explained in more detail in later sections of this Manual.**

## FOOT SWITCH

You can use a Foot Switch to control various functions - for example, switching Leslie rotor speeds.

**NOTE: You can assign a Foot Switch to control various functions. This is explained in more detail on page 132.**

## DAMPER PEDAL

You can use a Damper Pedal to hold or “damp” notes while it is pressed and held, similar to the damper pedal on an acoustic piano.

**NOTE: You can assign the Damper effect to the Voice Section or Sections you wish. This is explained in more detail on page 134.**

The SK PRO incorporates an exclusive Hammond feature called **MANUAL**, which is explained starting below.

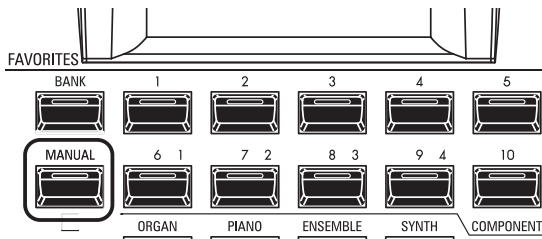

## WHAT IS “MANUAL”?

Normally, one of the [FAVORITE] buttons is “ON” (LED lit), indicating that a Combination is selected. However, if you want to de-select Combinations and use the front panel controls entirely to control the sound, turn the [MANUAL] button “ON.” The [FAVORITE] buttons will all turn “OFF” and all sounds and features of the SK PRO will be controlled by the front panel controls as well as by the settings from the Menus.

## INITIALIZE “MANUAL”

Some Menu Parameters may not be set the way you wish even if [MANUAL] is selected. If you encounter this, you can initialize all the MANUAL Parameters using the following procedure.

### ① LOCATE THE PLAY MODE

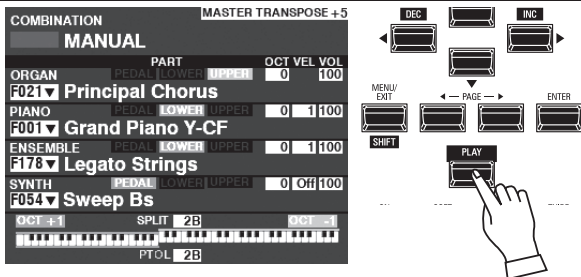

If the PLAY Mode is not displaying, press the [PLAY] button to display it.

### ② SELECT MANUAL

Press the [MANUAL] button “ON” (LED lit).

### ③ OPEN THE APP (APPLICATION) MENU

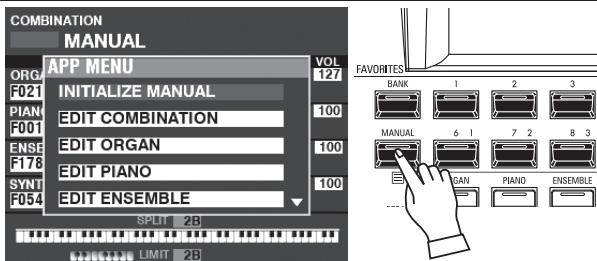

Press and Release the [≡] button to open the APP Menu.

### ④ SELECT “INITIALIZE MANUAL”

If “INITIALIZE [MANUAL]” is not already highlighted, use the [▲][▼] buttons to select it, and press the [ENTER] button. The screen shown below will display.

### ⑤ CHOOSE THE SECTION TO INITIALIZE

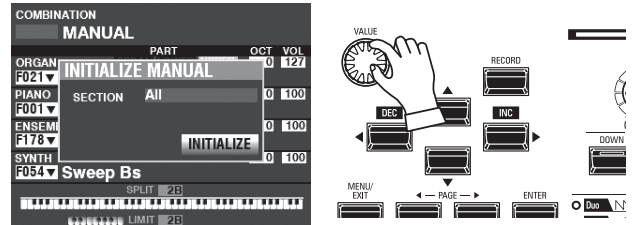

Use the [VALUE] knob to select which Section to Initialize - ALL, ORGAN or SYNTH.

### ⑥ COMPLETE THE PROCEDURE

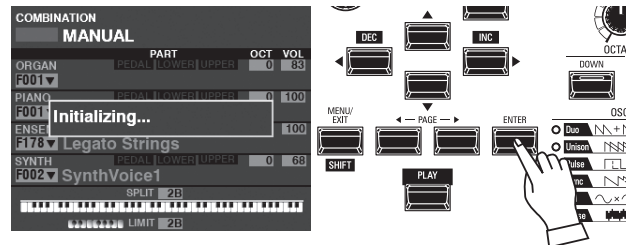

Use the [DIRECTION] [▼] button to move the cursor to the [INITIALIZE] icon, and press the [ENTER] button. The screen will display “Initializing...” for approximately 1 second.

**NOTE:** If you DO NOT wish to Initialize, press the [MENU/EXIT] or [PLAY] button instead of the [ENTER] button.

### tips “MANUAL”

The “Manual” feature cancels all Combinations, Patches, internal Parameters, etc. It works much the same way as the “Adjust Presets” on Hammond Organs with Preset Keys or the “Cancel” piston on many classic organs or on electronic home organs such as the Hammond XT/XH-series. The Hammond 935 Church Organ has a feature called “Panel Memory” which performs much the same function.

# USING ORGAN PATCHES

ORGAN Patches are explained in detail starting below.

## ALLOCATING THE SECTION TO THE KEYBOARD

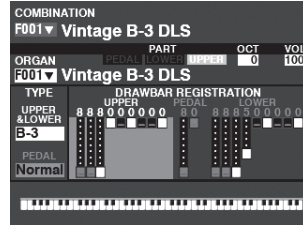
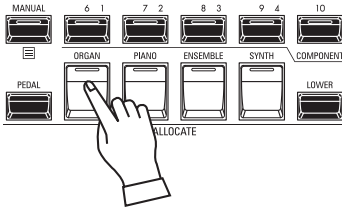

PLAY Mode (Organ)

To play an ORGAN Patch on the keyboard, simply press the [ORGAN] button in the [ALLOCATE] button group. The LED will light red.

**NOTE:** If only the ORGAN Section is active (no other [ALLOCATE] buttons lit), the PLAY Mode will display only the ORGAN Parameters.

**NOTE:** The ORGAN Section has a special mode called "3 PART ORGAN" which allows the SK PRO to replicate the performance of a vintage Hammond Organ with 2 manuals and Pedals.

## RECALLING A PATCH

For this example, recall "F011 Classic Gospel."

### ① MOVE THE CURSOR TO THE PATCH NUMBER

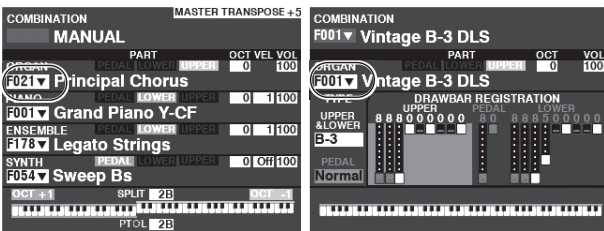

PLAY Mode (General)

PLAY Mode (Organ)

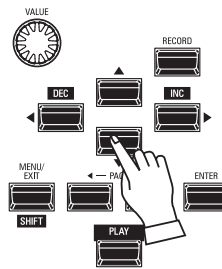

Use the [DIRECTION] buttons to move the cursor to the Patch Number in the ORGAN Section.

**NOTE:** The word "MANUAL" is explained in more detail on page 29.

### ② OPEN THE PATCH LIST

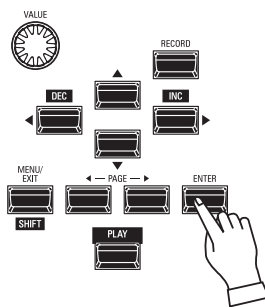
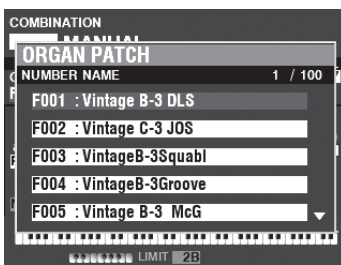

You can use the Patch List to display available Patches quickly. To open the Patch List, press the [ENTER] button when the Patch Number is highlighted in the display.

### ③ SELECT THE PATCH

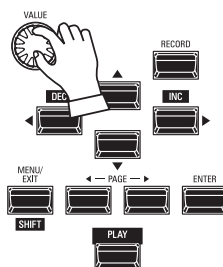
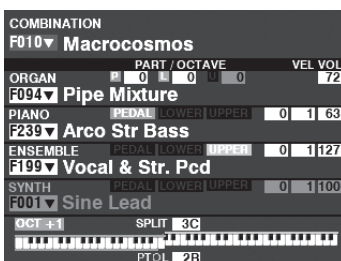

Use the [VALUE] knob to select the desired Patch. For this example, select "F011 Classic Gospel."

Press the [PLAY] or [ENTER] button to return from Patch List to PLAY Mode.

# ADJUSTING THE VOLUME

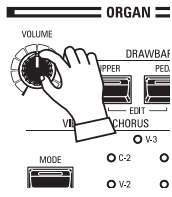
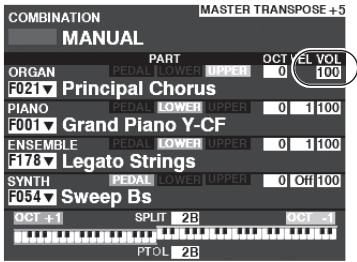

Use the [VOLUME] knob in the ORGAN Section to adjust the volume.

**NOTE:** You can also adjust the volume of the ORGAN Section in the PLAY screen by moving the cursor to "VOL" (right side of screen) and turning the [VALUE] knob.

**NOTE:** The word "MANUAL" is explained in more detail on page 29.

# CHANGING THE OCTAVE

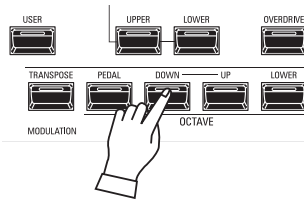
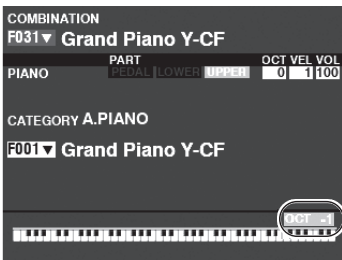

To change the Octave of the entire Keyboard (all Sections), press the OCTAVE [UP] or [DOWN] button. The display will show the current Octave setting.

**NOTE:** You can select "-2" (up to two octaves down) through +2" (up to two octaves up).

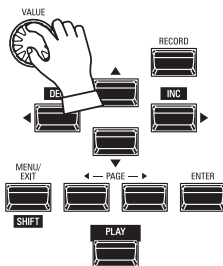
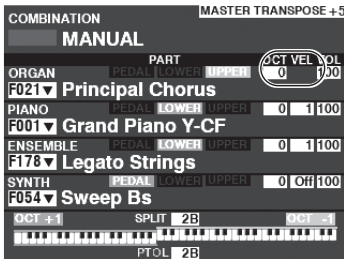

To change the Octave for the ORGAN Section only, use the [DIRECTION] buttons to move the cursor to "PLAY Mode - ORGAN Section - OCTAVE" and use the [VALUE] knob to change the Octave. The display will show the current Octave setting.

**NOTE:** You can select "-2" (up to two octaves down) through +2" (up to two octaves up).

# CREATING AN ORGAN PATCH

The ORGAN Section can be registered for vintage Hammond Organ sounds, Combo Organs, and Pipe Organs. This is explained in more detail starting below.

## SELECT [MANUAL]

Normally, one of the [FAVORITE] buttons is “ON” (LED lit), indicating that a Combination is selected. However, if you want to de-select Combinations and use the front panel controls entirely to control the sound, turn the [MANUAL] button “ON.” The [FAVORITE] buttons will all turn “OFF” and all sounds and features of the SK PRO will be controlled by the front panel controls as well as by the settings from the Menus.

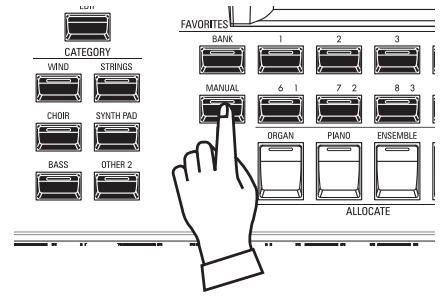

## INITIALIZE “MANUAL”

Some Menu Parameters may not be set the way you wish even if [MANUAL] is selected. If you encounter this, you can initialize the MANUAL Parameters (P. 29).

## ALLOCATE THE SECTION TO THE KEYBOARD

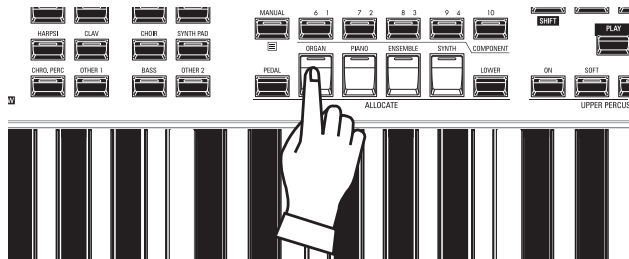

Press the [ORGAN] button in the [ALLOCATE] button group “ON.” The LED will light and the ORGAN Section will play from the keyboard.

## SELECT 3 PART ORGAN

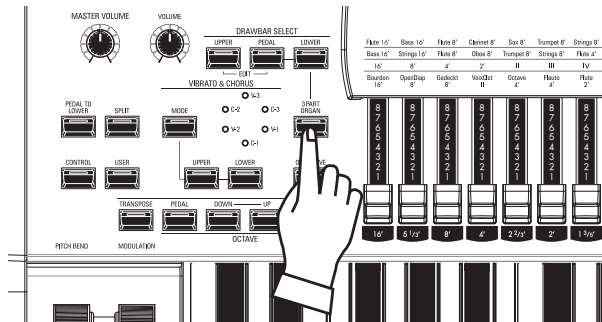

The ORGAN Section has 3 Parts - UPPER, LOWER and PEDAL. The [3 PART ORGAN] button selects how the 3 Parts are allocated. When “ON” (LED lit) the Upper, Lower and PEDAL Parts are allocated automatically. When “OFF” (LED not lit) the UPPER Part will play on the entire keyboard but the LOWER and PEDAL [ALLOCATE] button group buttons can still be used to allocate the entire ORGAN Section to the Lower or PEDAL Parts.

## SELECT THE ORGAN TYPE

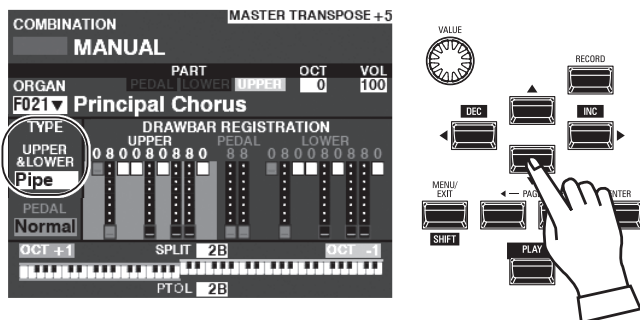

Select the ORGAN Type most appropriate to the musical style you wish to play.

Use the [DIRECTION] buttons to move the cursor to “ORGAN TYPE - UPPER&LOWER.”

Use the [VALUE] knob to select the ORGAN Type.

**NOTE: The word “MANUAL” is explained in more detail on page 29.**



## SELECT THE PART TO ADJUST

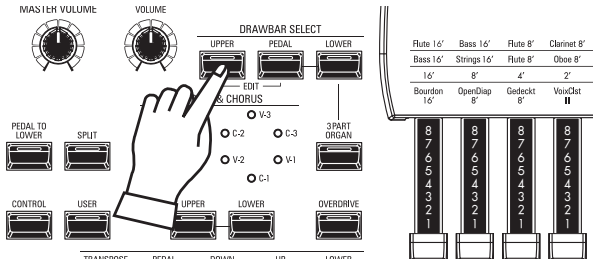

Use the [DRAWBAR SELECT] buttons to select which Part the Drawbars will adjust. For this example, press the [UPPER] button “ON” (LED lit).

## ADD DRAWBARS

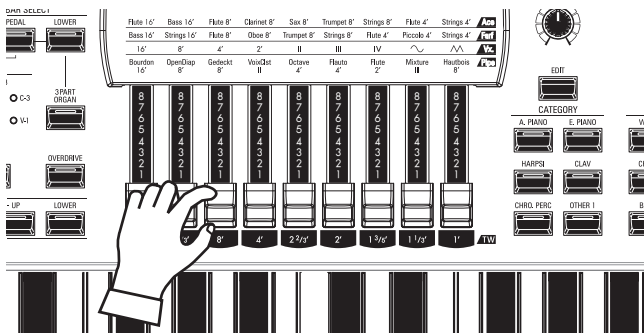

The Drawbars control the basic organ sounds. You can hear the effect each Drawbar has on the sound by pulling out or pushing in Drawbars while holding keys.

## ADJUST THE VOLUME

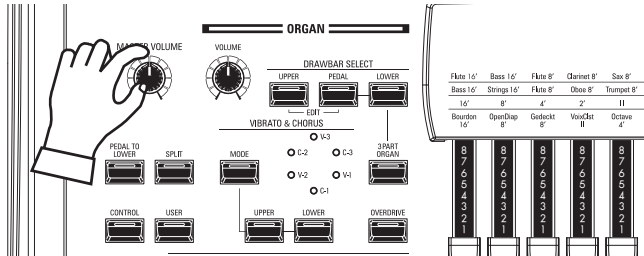

Use the [VOLUME] knob in the ORGAN Section to adjust the volume.

**NOTE:** You can also adjust the volume of the ORGAN Section in the PLAY screen by moving the cursor to “VOL” (right side of screen) and turning the [VALUE] knob.

## CHANGING THE OCTAVE

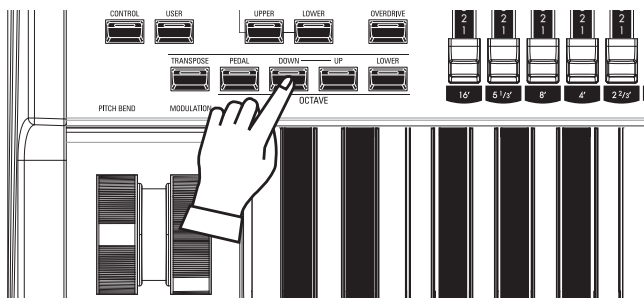

To change the Octave of the entire Keyboard (all Sections), press the OCTAVE [UP] or [DOWN] button. The display will show the current Octave setting.

To change the Octave for the ORGAN Section only, use the [DIRECTION] buttons to move the cursor to “PLAY Mode - ORGAN Section - OCTAVE” and use the [VALUE] knob to change the Octave. The display will show the current Octave setting.

**NOTE:** You can select “-2” (up to two octaves down) through +2” (up to two octaves up).

## ADDING PERCUSSION

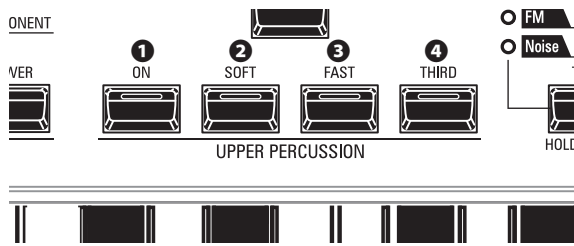

An important component of the Hammond Sound is “Touch-Response Percussion Control™.” The Percussion controls on the SK PRO consist of four separate buttons (shown at left) which control harmonic Percussion tones. These four buttons control all the same functions as the tilt tablets on a tone-wheel Hammond.

### 1 [ON] button

This tab, when “ON” (LED lit), turns the Percussion effect “ON.” The Percussion tone will sound in accordance with the settings for the other three Percussion controls.

**NOTE:** In the “ON” position, all of the Upper Manual Drawbars will be effective except the 1’ (fourth white) Drawbar. This duplicates the performance of a vintage tone-wheel organ such as a B-3/C-3/A-100. In the “OFF” position, the 1’ Drawbar is effective as usual. However, you can change this Parameter if you wish.

### 2 [SOFT] button

This tab regulates the volume of the Percussion tone. When it is “OFF” (LED not lit), the Percussion effect will be very prominent. The Drawbar tones will also be reduced in volume to compensate for the addition of the Percussion tones. When this tab is “ON” (LED lit), the Percussion effect is much less prominent. The volume of the Drawbar tones remains unaffected by the addition of the Soft Percussion effect.

### 3 [FAST] button

When this tab is “OFF” (LED not lit) the Percussion tone will decay slowly like a bell. When it is “ON” (LED is lit) the Percussion tone will decay rapidly like a xylophone.

### 4 [THIRD] button

This tab determines the pitch at which the Percussion tone sounds. When set at “SECOND” (LED not lit), the pitch is up one octave with respect to the Fundamental (8’) Drawbar; when set at “THIRD” the Percussion pitch is up an octave and a fifth with respect to the Fundamental Drawbar.

**NOTE:** The Percussion features works with the “A-100,” “B-3,” “C-3” and “Mellow” Organ types only, and on the UPPER Part only.

**NOTE:** You can adjust the Parameters of the Percussion to your liking. This is explained in more detail on page 126.

## ADDING EFFECTS TO THE ORGAN SECTION

### VIBRATO & CHORUS

“Vibrato & Chorus” allows you to add “Vibrato” (a periodic raising and lowering of pitch) or “Chorus” (a “shimmering” effect having the periodicity of Vibrato) to your Drawbar registrations.

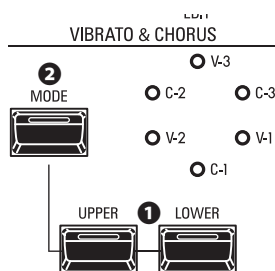

### 1 [UPPER], [LOWER] buttons

These allow you to turn Vibrato & Chorus “ON” or “OFF” for each Part. When “ON” the red LEDs will light.

### 2 [MODE] button

This allows you to select from three degrees of Vibrato and three degrees of Chorus. Each successive press of this button selects a different amount of Vibrato or Chorus.

**NOTE:** When the ORGAN Mode is set to “Pipe,” the Vibrato & Chorus works as a pipe organ Tremulant. You can select from six degrees of Tremulant. This is explained in more detail on page 126.

**NOTE:** You can adjust the Vibrato & Chorus effect to your liking. This is explained in more detail on page 86.

## LESLIE

The SK PRO has an inbuilt digital Leslie that replicates the sound of a twin-rotor Leslie Speaker Cabinet. In addition, the instrument can also be used with a variety of different Leslie Speaker Cabinets.

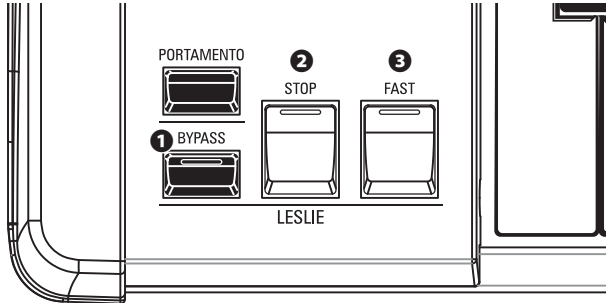

### 1 [BYPASS] button

Disables the digital Leslie, producing a “dry” organ sound.

### 2 [STOP] button

To toggle between “FAST” and “SLOW” when the [FAST] button is pressed, turn this button “OFF” (LED not lit).

To toggle between “FAST” and “STOP” when the [FAST] button is pressed, turn this button “ON” (LED lit).

### 3 [FAST] button

Toggles between “FAST” (LED lit) and “SLOW” (LED not lit).

**NOTE:** The digital Leslie is **not** available for the Pipe Organ.

**NOTE:** These controls perform the same functions when a Leslie Speaker Cabinet is connected via the 11-pin socket.

**NOTE:** You can fine-tune the Parameters of the inbuilt digital Leslie. This is explained in more detail starting on pages 88 and 191.

## OTHER EFFECTS

### - OVERDRIVE

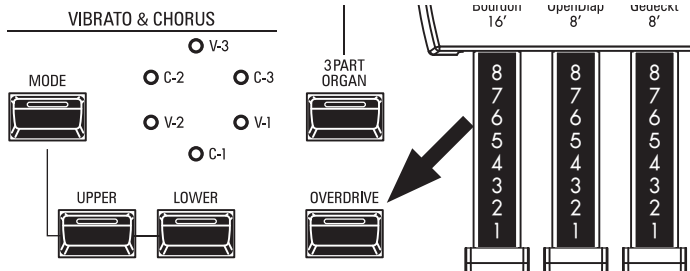

“Overdrive” adds distortion to the sound by increasing the pre-amplifier input gain. Press the OVERDRIVE button to turn the Overdrive effect “ON” (LED lit) or “OFF” (LED not lit).

### - MULTI-EFFECTS

There are several **Multi Effects** which you can use to enhance the sound.

### - REVERB

The SK PRO has built-in Reverb (reverberation) which allows you to simulate several different acoustic profiles.

### tips LESLIE BUTTONS AND MODES

BUTTON			MODE	
BYPASS	STOP	FAST	CH=1	CH=3 or digital Leslie
Off	Off	On		Fast
Off	Off	Off		Slow
Off	On	On		Fast
Off	On	Off		Stop
On	On	On	Fast	Bypass
On	On	Off	Stop	
On	Off	On	Fast	
On	Off	Off	Slow	

### tips WHAT IS THE LESLIE EFFECT?

When the Hammond Organ was first introduced in the mid 30's, the sound-producing apparatus was not contained within the console. A separate “tone cabinet” had to be connected to the organ console via a special cable. For many years, Hammond manufactured tone cabinets specifically for use with Hammond Organs. The best known of these is probably the PR-40 model.

In the late 30's, an independent engineer and organ enthusiast named Donald J. Leslie found that rotating a baffle in front of a stationary speaker created the effect of a tremulant (the well-known “Doppler effect”) and called the subsequent speaker the “Vibratone.” (The “Vibratone” designation was eventually dropped and subsequent models would be known simply as Leslie Speakers.) Many models of Leslie Speakers have been made over the years; probably the best known being the models 122, 142, 145 and 147. The figure below shows the configuration of a typical twin-rotor Leslie Speaker Cabinet.

The inbuilt digital Leslie on the SK PRO reproduces all three modes - Fast, Slow and Off. In addition, all three modes are available when the SK PRO is connected to an 11-pin Leslie Speaker Cabinet.

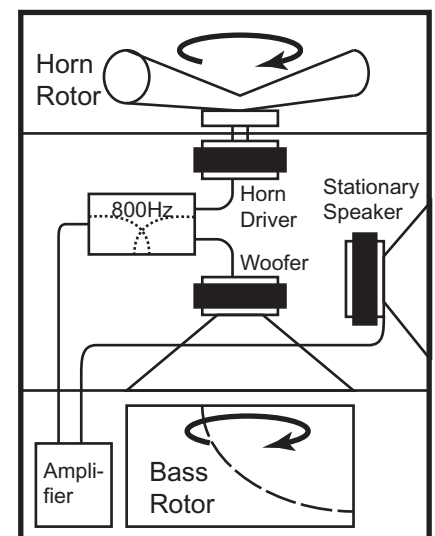

## KEYBOARDS AND PARTS

The classic Hammond Organ has two manuals or keyboards and a pedal keyboard (or pedal clavier). Commonly, the two keyboards will be registered differently - for example, the Upper Keyboard will have a registration appropriate for Melody while the Lower Keyboard will have an Accompaniment registration to provide harmonic backing for the Melody. In addition, the Pedals will have a setting appropriate for bass notes.

The ORGAN Section of the SK PRO can function as a classic Hammond Organ by dividing or “Splitting” the keyboard into two Parts. When SPLIT is active, “UPPER” is the portion of the keyboard to the right of the SPLIT Point and “LOWER” is to the left of the SPLIT Point.

In addition, the PEDAL Part can be played either from a connected MIDI pedalboard, or from the keyboard by using the PEDAL TO LOWER feature when SPLIT is active.

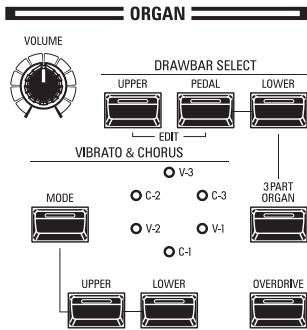
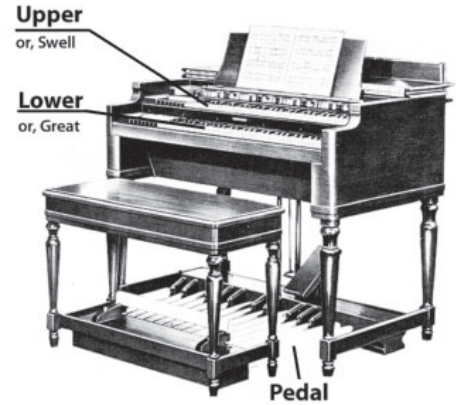

### 1 [3 PART ORGAN] button

This allows you to select whether the ORGAN Section will function as a classic Hammond Organ with two manuals and pedals or as a single-manual organ.

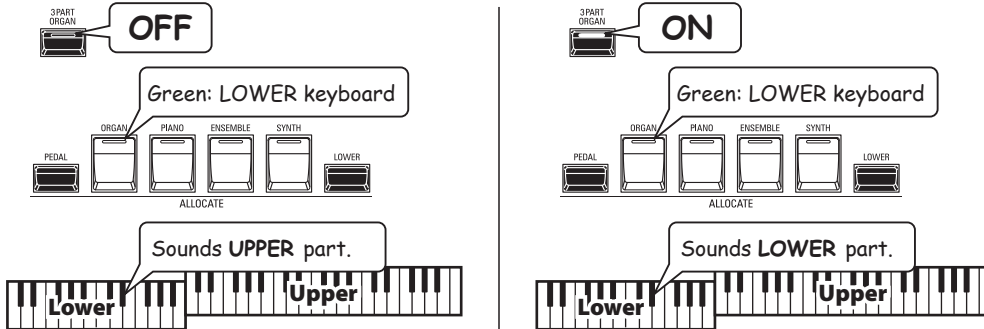

**ON** .....The ORGAN Section will function as a classic two-manuals-and-pedals Hammond Organ.

**OFF** .....The ORGAN Section can either sound on the entire keyboard, or be dynamically assigned to UPPER, LOWER or PEDAL.

### 2 [DRAWBAR SELECT] buttons

Allow you to use the Drawbars to control the sounds for each ORGAN Part. If the LED of one of these buttons is lit, the Drawbars will control the sounds represented by that button.

## ORGAN TYPES

The Drawbars on your SK PRO can be made to control organ sounds other than traditional Hammond Drawbars. Several makes of combo organs, for example, also used Drawbar-type controls to register the sounds, which were actual organ voices rather than individual harmonics as with Hammond Drawbars.

### TONE WHEEL (A-100, B-3, C-3)

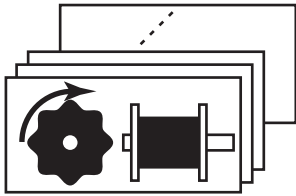

The Hammond Organ's original purpose was to duplicate the pipe organ, however, they became famous for producing a unique sound of their own.

Tone Wheels are the method by which tone-wheel Hammond Organs generate sound. Each frequency is generated by a steel disk 1 7/8" in diameter and containing a number of high spots on its outer edge. (See the illustration above.) These disks are the Tone Wheels. The most common tone-wheel generator has a total of 96 tone wheels, all with different numbers of teeth - some wheels have 2 teeth, others have 4, 8, 16, 32, 64, 128, up to 192 teeth. The classic Tone Wheel design uses 91 tone wheels to generate the musical tones.

**A-100**, **B-3** and **C-3** are traditional Tone Wheel sounds.

### MELLOW

The **Mellow** setting replicates the non-mechanical electronic Hammond tone generators such as the Concorde, the X-5 combo organ and the later "multiplex" organs such as the B-3000 and 340 series Elegante.

### TRANSISTOR (Vx, Farf, Ace)

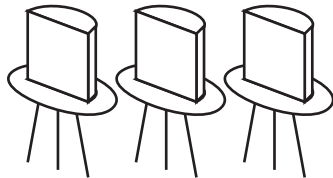

As transistors gradually replaced vacuum tubes in electronic circuits it became possible to produce light-weight combo organs. These have been used extensively in rock and popular music since the early 60's. The type of circuitry is different from maker to maker or model by model. We have replicated 3 representative types here.

**Vx** replicates a British combo organ which combines triangle waves and square waves using several footages. "Farf" and "Ace" both replicate combo organs (Italian and Japanese) which use tablets to combine sound waves which are filtered to produce different tones.

### PIPE

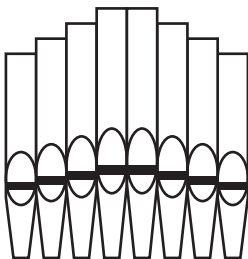

A pipe organ produces sounds by pushing pressurized air through sets of wood or metal pipe called Ranks or Stops. There are many different types of Pipe Stops which produce sounds of different pitches, timbres and levels of volume. Each Stop is identified by a unique Name indicating what type of sound it will produce when selected.

The **Pipe** Organ replicates several different types of pipe organs by using the Drawbars as drawstops or stop tablets to create pipe organ registrations.

#### tips PEDAL ORGAN TYPES

When using the Tone Wheel Organs (**A-100**, **B-3**, **C-3** or **Mellow**) for the UPPER & LOWER Parts, you can select two different PEDAL Voicings - **Normal** and **Muted**. **Normal** replicates the Pedal Drawbars of a vintage Hammond Organ while **Muted** more nearly duplicates the mellow Pedal Drawbar tones of an electronic Hammond.

On the Transistor Organs (**Vx**, **Farf**, and **Ace**), the PEDAL Voicing is automatically set to **Muted**. For **Pipe**, the Pedal Drawbars register Pipe organ voices to complement the UPPER and LOWER Pipe Voices.

# HARMONIC DRAWBARS™

The Harmonic Drawbars are the heart of the renowned Hammond Sound and have been used since the first Hammond Organ Model A was introduced in 1935. There are approximately 253,000,000 possible sound combinations that can be produced by these Drawbars. The illustration below shows how each Drawbar relates to the keyboard when middle “C” is pressed.

**NOTE:** When recalling Combinations or ORGAN Patches, the positions of the Drawbars will change internally, but not physically. When a Drawbar is moved, the Patch setting will update to that Drawbar’s current position. You can also match the entire Drawbar registration to the physical Drawbar setting. See page 45 for more information.

## DRAWBARS (A-100, B-3, C-3, Mellow)

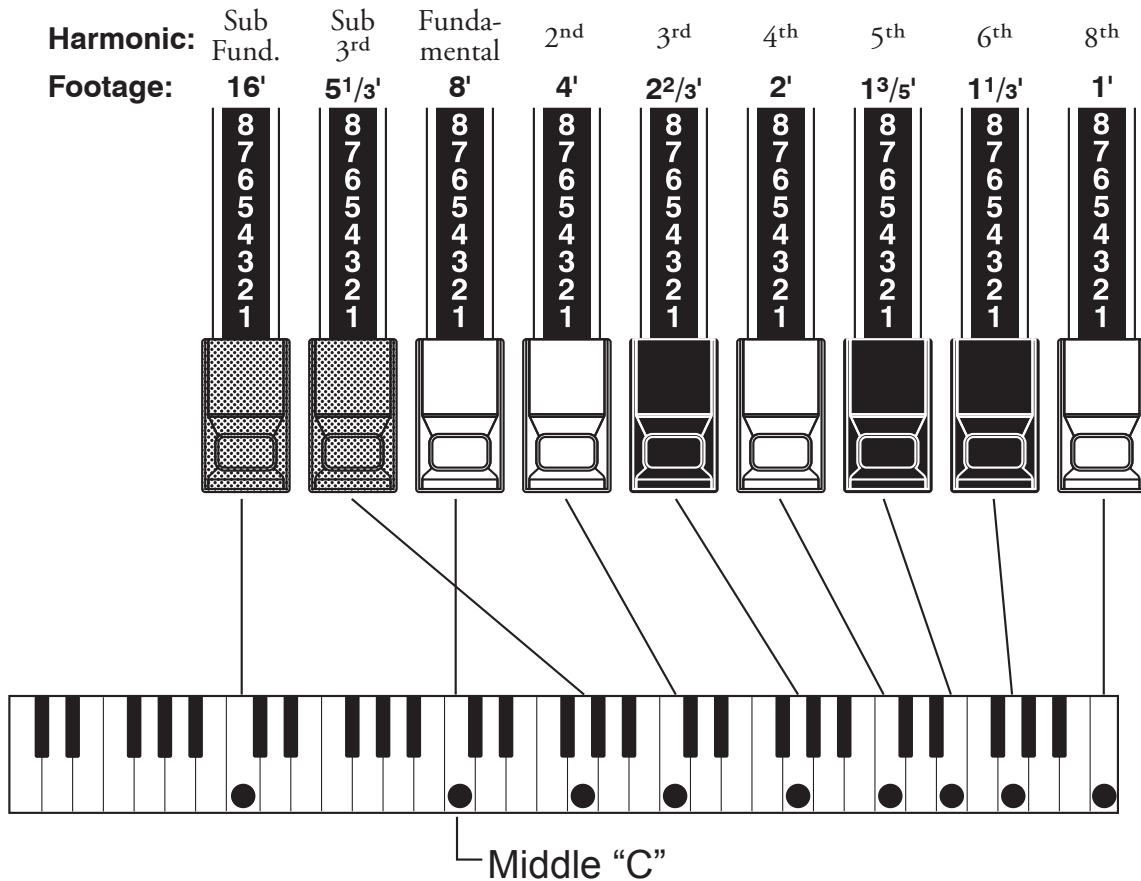

Each Drawbar may be set in eight different positions in addition to the silent or “0” position. Each position, as marked on the Drawbars, represents a different degree of intensity of the harmonic it controls. When drawn out to position “1,” the harmonic it represents will be present with minimum intensity, when drawn out to position 2 with greater intensity, and so on up to position “8.”

If you pull the fundamental (8’) the third harmonic (2 2/3’) plus the fifth harmonic (1 3/5’) Drawbars out completely and play the keyboard you will notice the sound resembles a clarinet.

If you pull the 8’ Drawbar half-way, you’ll notice the sound becomes more high-pitched and a bit “harder.” Now pull the 8’ Drawbar back out fully and push the 2 2/3’ and 1 3/5’ in halfway. Notice how the sound becomes mellower.

Experiment with the Drawbars to obtain your own favorite registrations.

### **tips** DRAWBAR REGISTRATION

Below is an example of using Drawbars to create different sounds.

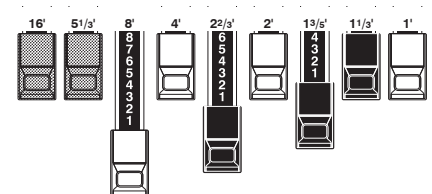

Example of “Clarinet”



For “Tone Wheel” Organs, the relationship between each Drawbar and its footage is shown on the “TW” legends directly in front of the Drawbars.

# DRAWBARS FOR THE UPPER AND LOWER PARTS

The Colors of the Drawbars are traditional to Hammond, and were established to provide a quick visual guide to the harmonics generated by the Drawbars.

## WHITE DRAWBARS

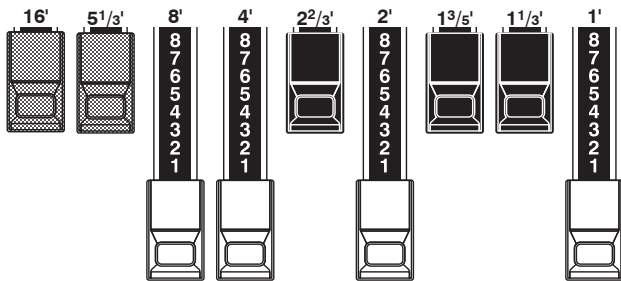

The first white Drawbar represents the “fundamental” or “8’ base” tone. All of the other white Drawbars are octave intervals or harmonics of the fundamental tone. The tonal brilliance is greatly increased by adding white Drawbars, but the harmonics added are always in “consonance” or harmony.

## BLACK DRAWBARS

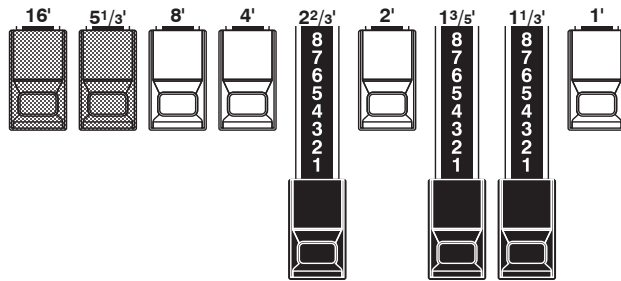

The black Drawbars represent the “dissonant” harmonics which are also necessary in building rich tone colors. The mellowness of a horn, the pungency of strings, and the brilliance of reed voices owe much of their character to the presence of these harmonics in different degrees.

## BROWN DRAWBARS

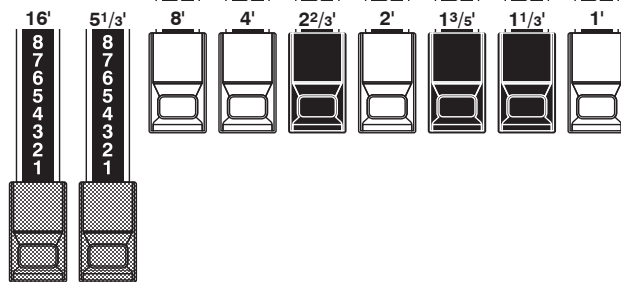

The two brown Drawbars on the far left give depth and richness to the sound. The left 16’ is one octave lower than the 8’, and 5 1/3’ is the third harmonic of the 16’ fundamental. Normally, the tones are built on the 8’ fundamental, but, if you want to add depth to the tone or to expand the playing range by one octave lower, build your tones on the 16’ fundamental.

## PEDAL DRAWBARS

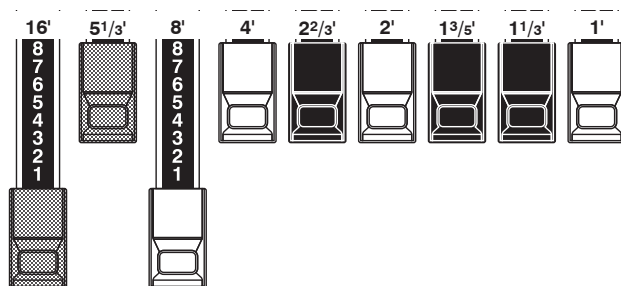

The 16’ and 8’ Drawbars control the sounds produced by the Pedal part. The first brown Drawbar produces a composite tone at 16’ pitch for a deep foundation bass, while the first white Drawbar produces a composite tone at 8’ pitch, or one octave higher.

## DRAWBAR REGISTRATION PATTERNS

Regardless of the size of a pipe organ or its number of stops, all of its voices are related to four basic families of tone. The four basic families - Flute, Reed, String and Diapason - can be quickly set up on the Drawbars by relating a pattern or shape to each family.

### FLUTE FAMILY (2 STEP PATTERN)

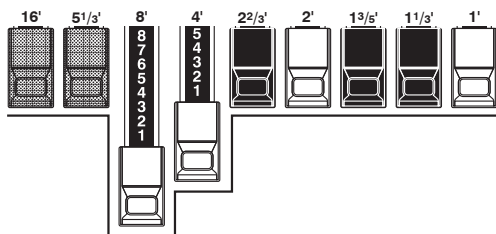

Accompaniment Flute 8' I.....	00 8460 000
Accompaniment Flute 8' II.....	00 3220 000
Accompaniment Flute 8' III.....	00 8600 000
Chorus of Flutes 16'.....	80 8605 002
Orchestral Flute 8'.....	00 3831 000
Piccolo 2'.....	00 0006 003
Stopped Flute 8'.....	00 5020 000
Tibia 8'.....	00 7030 000
Tibia 4'.....	00 0700 030
Tibia (Theater) 16'.....	80 8605 004
Wooden Open Flute 8'.....	00 8840 000

### DIAPASON FAMILY (CHECK MARK PATTERN)

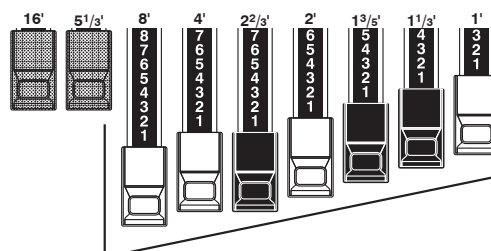

Accomp. Diapason 8'.....	00 8874 210
Chorus Diapason 8'.....	00 8686 310
Diapason 8'.....	00 7785 321
Echo Diapason 8'.....	00 4434 210
Harmonic Diapason 16'.....	85 8524 100
Harmonic Diapason 8'.....	00 8877 760
Harmonic Diapason 4'.....	00 0606 045
Horn Diapason 8'.....	00 8887 480
Open Diapason 8'.....	01 8866 430
Solo Diapason.....	01 8855 331
Wood Diapason 8'.....	00 7754 321

### REED FAMILY (TRIANGLE PATTERN)

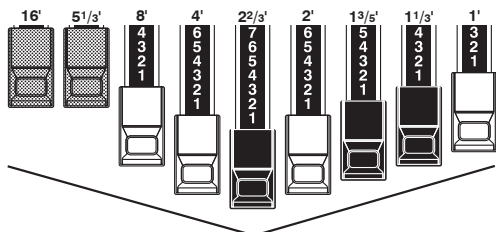

Bassoon 16'.....	44 7000 000
Clarinet 8'.....	00 6070 540
English Horn 8'.....	00 3682 210
Flugel Horn 8'.....	00 5777 530
French Horn.....	00 7654 321
Kinura 8'.....	00 0172 786
Oboe 8'.....	00 4764 210
Trombone 8'.....	01 8777 530
Trumpet 8'.....	00 6788 650
Tuba Sonora 8'.....	02 7788 640
Vox Humana 8'.....	00 4720 123

### STRING FAMILY (BOW PATTERN)

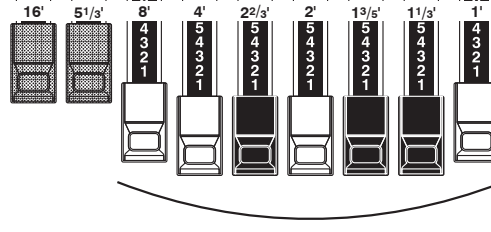

Cello 8'.....	00 3564 534
Dulciana 8'.....	00 7770 000
Gamba 8' I.....	00 3484 443
Gemshorn 8'.....	00 4741 321
Orchestral String 8'.....	00 1464 321
Salicional 8'.....	00 2453 321
Solo Viola 8'.....	00 2474 341
Solo Violin 8'.....	00 3654 324
Viola da Gamba 8'.....	00 2465 432
Violina 4'.....	00 0103 064
Violone 16'.....	26 3431 000

Notice that Drawbar registrations are expressed in number groups of 2, 4 and 3. This "2-4-3" number formula for Drawbar Registration has been a Hammond convention since the beginning. It has been found to be the easiest way to convey a specific setting. The first two numbers correspond to the two brown Drawbars of either manual. The middle four numbers designate the 8', 4', 2 2/3', 2' Drawbars, and the remaining three numbers refer to the last three Drawbars.



# MODERN DRAWBAR REGISTRATIONS

The Drawbar registration patterns shown on the previous page are intended to simulate the four basic families of tone found on a classical pipe organ, since this was the original intention of the Hammond Organ. Later on, as the Hammond Organ began to be used in Jazz, Pop and Rock music, other sounds became identified with the "Hammond Sound." The figures below illustrate some of these modern registrations.

## JAZZ

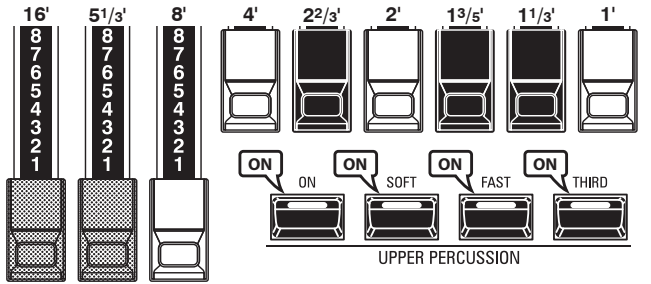

## BLUESY

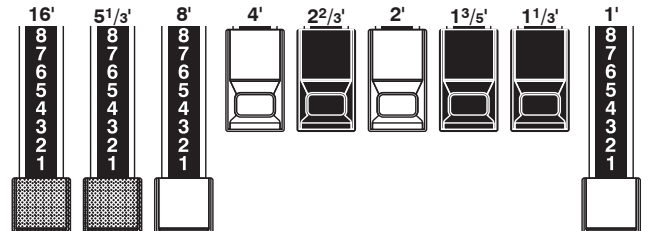

## GROOVY & FUNKY

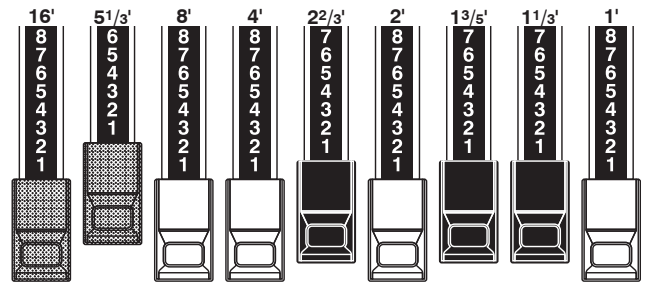
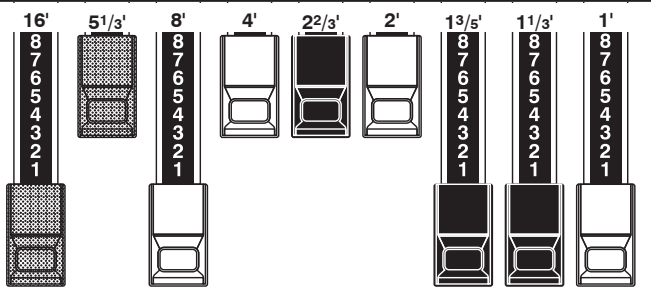

## SQUABBLE ("Erroll Garner" Registration)

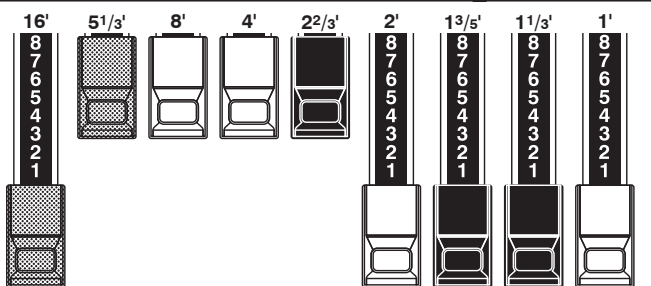

### tips APPLICATION OF PERCUSSION

When Percussion is used, the sound of the 1' Drawbar is cancelled just as it is on vintage organs (B-3, C-3, A-100, M-3, etc.). Some jazz organists have taken advantage of this idiosyncrasy by keeping the 1' Drawbar pulled out and turning Percussion "ON" and "OFF" while playing. The result is an instantaneous registration change with a single motion.

# DRAWBARS (Vx)

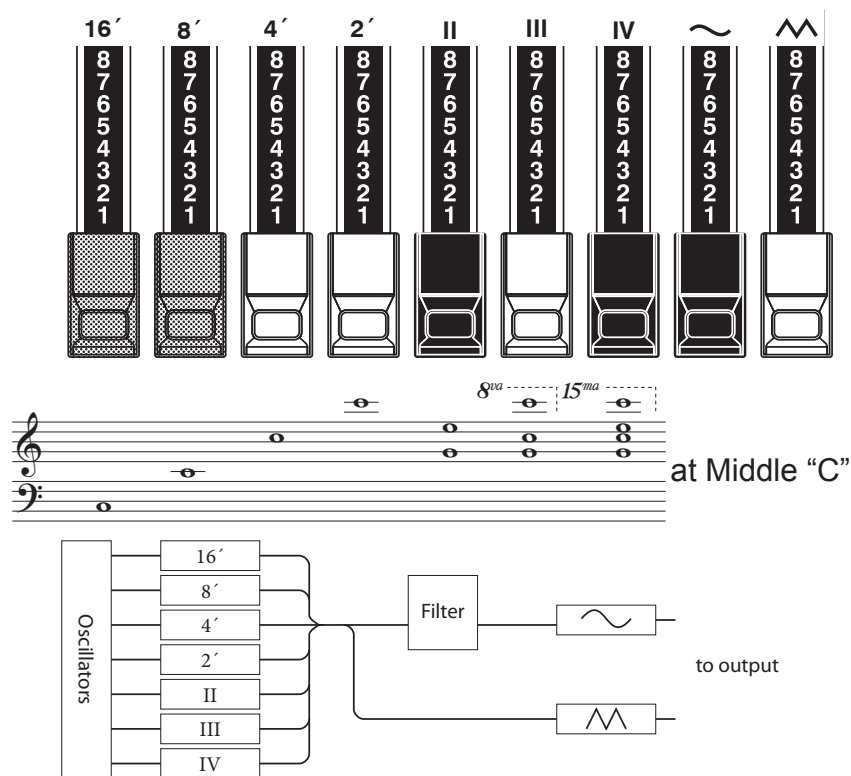

The type of British combo organ replicated by the “Vx” ORGAN Type had Drawbar-type controls, but they functioned differently from Hammond Harmonic Drawbars. The first four Drawbars control individual pitches, while the next three are “Mixture” Drawbars which cause multiple pitches to sound. “II,” “III” and “IV” refer to the number of pitches represented by that Drawbar.

The last two Drawbars control the type of tone produced by the first seven Drawbars.

The “~” Drawbar causes mellow tones to sound while the “^” Drawbar causes brighter and more harmonically complex tones to sound.

**NOTE: The first seven Drawbars WILL NOT sound unless one or both of the right two Drawbars are also “out.” These two Drawbars regulate the overall volume as well as timbre of the total Drawbar registration, and can be used separately or together.**

**tips FOOTAGE**

“Footage” is a term inherited from the pipe organ. It is used to designate the pitch at which a particular organ stop will sound. The number refers to the length of pipe necessary to produce the lowest note of that particular stop. For example, if a stop is marked “8” it means that the lowest note on a standard 5-octave organ keyboard “C” will require a pipe 8 feet long.

Flute 16'	Bass 16'	Flute 8'	Clarinet 8'	Sax 8'	Trumpet 8'	Strings 8'	Flute 4'	Strings 4'	<b>Aca</b>
Bass 16'	Strings 16'	Flute 8'	Oboe 8'	Trumpet 8'	Strings 8'	Flute 4'	Piccolo 4'	Strings 4'	<b>Farf</b>
16'	8'	4'	2'	II	III	IV	~	^	<b>Vx</b>
Bourdon 16'	OpenDiap 8'	Gedeckt 8'	VoixClst II	Octave 4'	Flauto 4'	Flute 2'	Mixture III	Hautbois 8'	<b>Pipe</b>

When using the “Vx” ORGAN Type, refer to the “Vx” row above the Drawbars for the correspondence between each Drawbar and the voice, footage and timbre.

# DRAWBARS (Farf, Ace)

## Farf

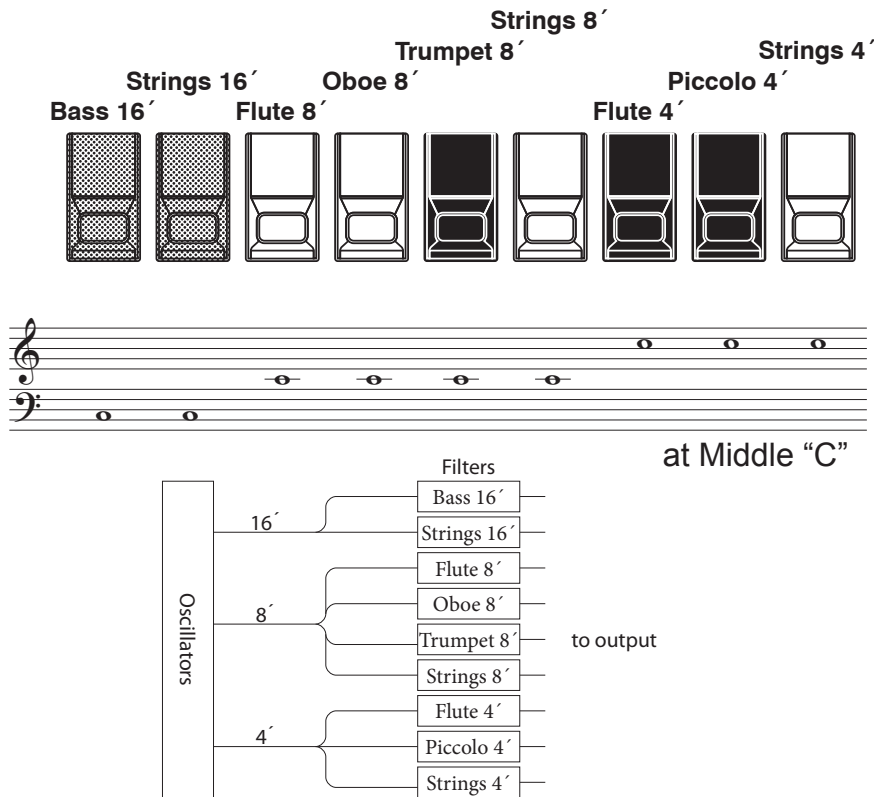

The figures to the left follow the layout of the Italian “Combo Compact” and the “TOP 7” combo organs, which used rocker-type tilt tablets rather than Drawbars to turn voices “ON” and “OFF.” On the SK PRO, the Drawbars are used to control the same sounds.

To replicate the effect of tablets, simply pull the Drawbar(s) representing the tone(s) you want “out” all the way. Or, you can create shadings of tones by using the Drawbars in the more traditional fashion.

**tips** TABLET

The word “tablet” refers to a tilting or “rocker”-type control used on many analog organs to turn voices “ON” and “OFF” as well as to add effects (see figure below).



## Ace

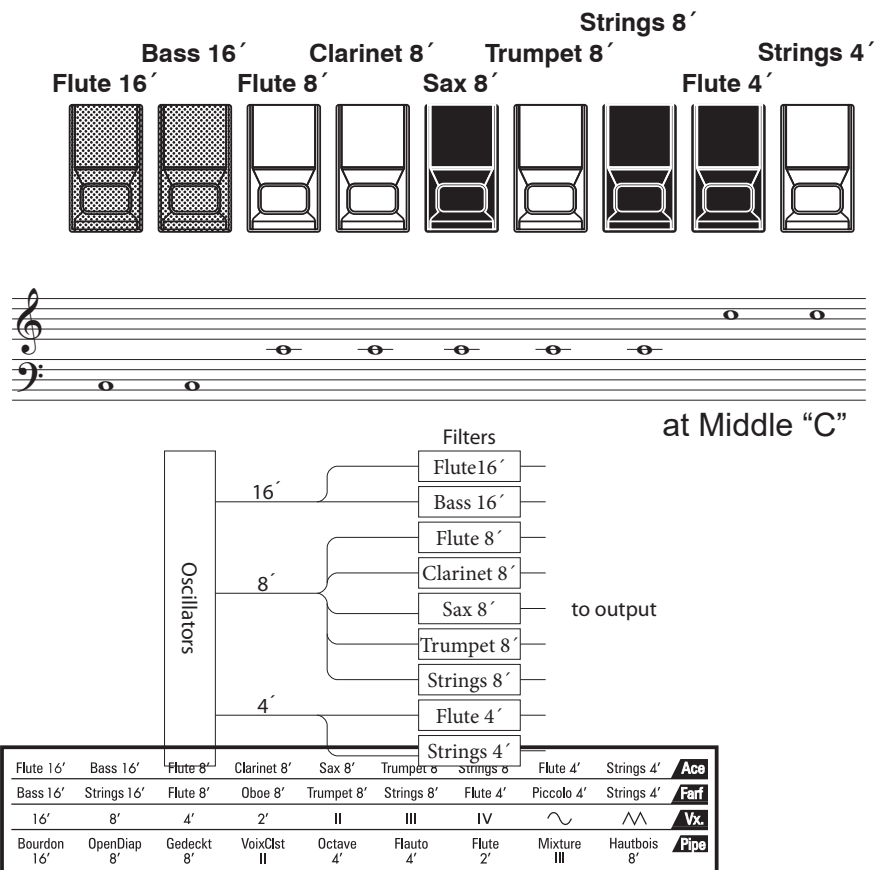

When using the “Farf” or “Ace” ORGAN Types, refer to the “Farf” or “Ace” row above the Drawbars for the correspondence between each Drawbar and the voice and footage.

# DRAWBARS (Pipe)

## F1: Classic

UPPER: Bourdon 16'    Open Diapason 8'    Gedeckt 8'    Viole Celeste II    Octave 4'    Flauto Dolce 4'    Flute 2'    Mixture III    Hautbois 8'

LOWER: Principal 16'    Principal 8'    Melodia 8'    Rohr Flute 8'    Prestant 4'    Flute 4'    Super Octave 2'    Mixture IV    Trom-pette 8'

PEDAL: Sub Bass 16' + Gedeckt 8'    Diapason 8' + Flute 4'

When using the Pipe Organ, the stops are registered through the Drawbars. The Classic type follows the classic organ layout left to right as follows: Flue, Mixture and Reed.

On the UPPER and LOWER Parts, each Drawbar corresponds with a pipe organ rank or stop.

On the PEDAL part, two stops sound with one Drawbar (Complex Stop).

**NOTE:** When "Classic" is activated, the Drawbars will function in a manner similar to drawstops on a traditional pipe organ - pulling a Drawbar "out" will turn the associated Pipe Voice "ON" while pushing the Drawbar "in" will turn the Pipe Voice "OFF." The Pipe Voices do not have gradations of volume - they are either "ON" or "OFF."

**NOTE:** The labels "F1," "F2" etc., refer to Custom Pipes.

**NOTE:** The digital Leslie is not available on the Pipe Voices. However, the Vibrato/Chorus feature becomes a pipe organ Tremulant when the PIPE Organ Type is selected.

## F2: Theatre 1

UPPER: Tibia Clausa 16'    Vox Humana 8'    Style "D" Trumpet 8'    Tibia Clausa 8'    Clarinet 8'    Viol d'Orch 8'    Vox Humana 8'    Tibia Clausa 4'    Tibia Clausa 2'

LOWER: Style "D" Trumpet 8'    Open Diapason 8'    Clarinet 8'    Viol d'Orch 8'    Flute 8'    Vox Humana 8'    Open Diapason 4'    Tibia Clausa 4'    Vox Humana 4'

PEDAL: Tibia 16' + Flute 8'    Diapason 8' + Flute 4'

The Theatre 1 and Theatre 2 PIPE settings provide a complement of organ stops characteristic of a theatre or "cinema" organ. "Theatre 1" is a stop complement similar to a Wurlitzer "Style 210" while "Theatre 2" is derived from the stops from a Wurlitzer "Style 260 Special," including English Post Horn. The figures on the left show the stop complements for the Theatre 1 and Theatre 2 Custom Pipe sets.

**NOTE:** When "Theatre 1" or "Theatre 2" is activated, the Drawbars will function similar to tablets on a theatre organ console.

## F3: Theatre 2

UPPER: Tibia Clausa 16'    English Post Horn 16'    Brass Trumpet 8'    Tibia Clausa 8'    Clarinet 8'    Vox Humana 8'    Tibia Clausa 4'    Tibia Clausa 2 2/3'    Tibia Clausa 2'

LOWER: Brass Trumpet 8'    Diapason 8'    Clarinet 8'    Viol Celeste 8'    Oboe 8'    Flute 8'    Vox Humana 8'    Viol Celeste 4'    Flute 4'

PEDAL: Tibia 16' + Flute 8'    Diapason 8' + Flute 4'

**tips STOP**

A single voice or sound on a pipe organ is referred to as a "Stop" due to the fact that air flow is "stopped" (or started) by manipulating the individual controls which turn sounds "ON" or "OFF."

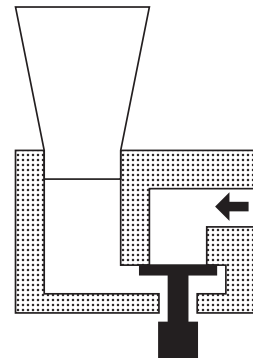

Flute 16'	Bass 16'	Flute 8'	Clarinet 8'	Sax 8'	Trumpet 8'	Strings 8'	Flute 4'	Strings 4'	<b>Ace</b>
Bass 16'	Strings 16'	Flute 8'	Oboe 8'	Trumpet 8'	Strings 8'	Flute 4'	Piccolo 4'	Strings 4'	<b>Farf</b>
16'	8'	4'	2'	II	III	IV	~	^	<b>Vx</b>
Bourdon 16'	Open Diap 8'	Gedeckt 8'	Voix Clst II	Octave 4'	Flauto 4'	Flute 2'	Mixture III	Hautbois 8'	<b>Pipe</b>

If the ORGAN Type is "Pipe," refer to the "Pipe" row on the other side of the Drawbars for the correspondence between each Drawbar and the footage.

## MATCHING THE REGISTRATION TO THE DRAWBAR SETTING

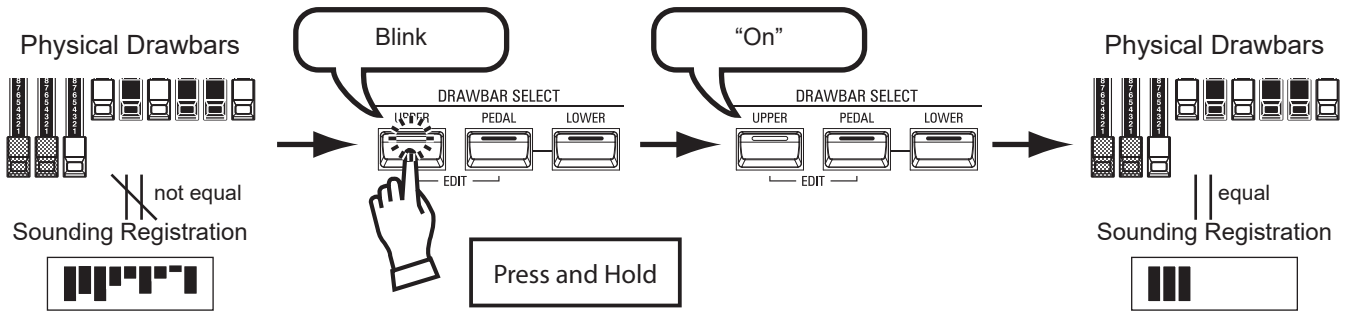

When you recall an ORGAN Patch, the Drawbar registration of the Recorded Patch is heard, instead of the physical Drawbar setting. If you move any Drawbar, its position takes precedence over the Recorded registration, although the Patch is not changed.

If you want to switch to the physical Drawbar setting immediately, Press and Hold any of the three DRAWBAR SELECT buttons ([UPPER] [PEDAL] or [LOWER]) until the button LED blinks then release it. The physical registration now becomes “current” for the selected Part.

## SHOWING CURRENT SETTINGS

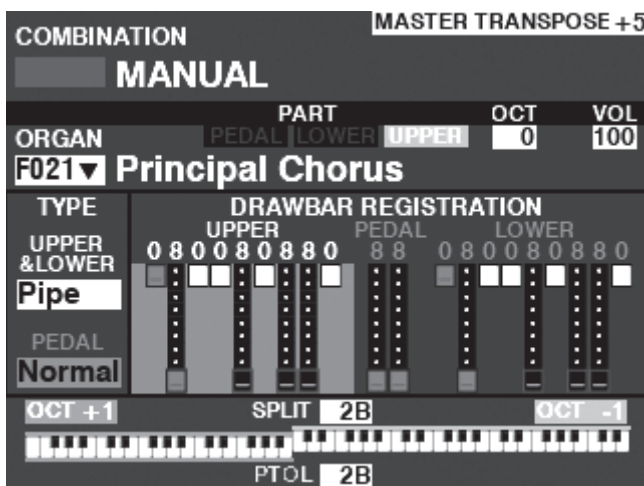

When you are in PLAY Mode, a page similar to the one shown at left will display if the ORGAN Section only is selected via the [ALLOCATE] button or by repeatedly touching the [PLAY] button.

**NOTE:** The word “MANUAL” is explained in more detail on page 29.

# USING PIANO AND ENSEMBLE PATCHES

The PIANO and ENSEMBLE Voice Sections allow you to play various instrumental and vocal sounds such as Piano, Strings, Trumpet, Choir, etc. This is explained in more detail starting below.

## ALLOCATING THE SECTION TO THE KEYBOARD

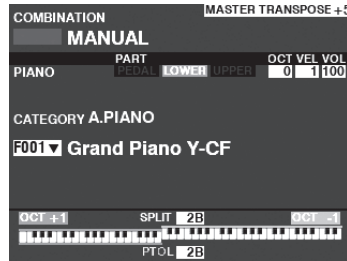
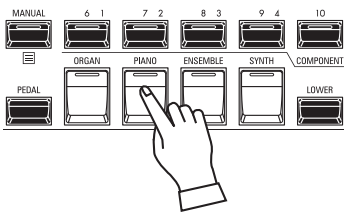

PLAY Mode (Piano)

To play a PIANO or ENSEMBLE Patch on the keyboard, simply press the [PIANO] or [ENSEMBLE] button in the [ALLOCATE] button group. The LED will light red.

**NOTE:** If only the PIANO or ENSEMBLE Section is active (no other [ALLOCATE] buttons lit), the PLAY Mode will display only the PIANO / ENSEMBLE Parameters.

**NOTE:** If the SPLIT button is "ON" (LED lit), the PIANO / ENSEMBLE will play to the right of the SPLIT Point only.

## RECALLING A PATCH

For this example, recall "EP Tine Mk2"

### ① SELECT A CATEGORY

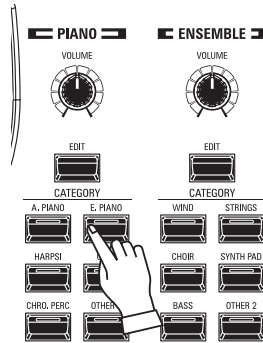

Select a Voice Category from the PIANO or ENSEMBLE Section. For this example, press the [E. PIANO] button in the PIANO Category. The display will show the Patch List for the selected category.

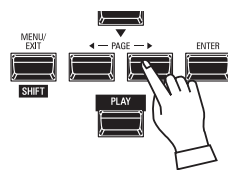
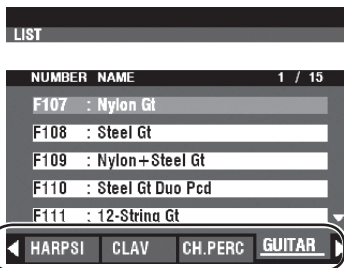

### USING THE "OTHER" VOICE CATEGORY

Both the PIANO and ENSEMBLE Voice Sections have a category called [OTHER]. These include various groups of Voices not represented by buttons on the Control Panel.

To select a Voice in the [OTHER] Category:

1. Press the [OTHER] button to display the Patch List.
2. Use the [PAGE] [◀]/[▶] buttons to select among the available Voice Categories.
3. Use the [DIRECTION] [▲]/[▼] buttons to select a Voice from the selected Category. Press [ENTER] to select the Voice you wish.

### ② SELECT THE PATCH

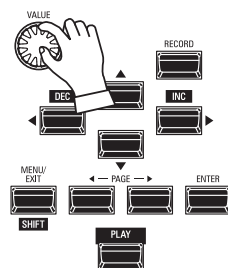

Use the [VALUE] knob to scroll through the Patch List.

**NOTE:** You can also use the PAGE [◀]/[▶] buttons to scroll through the Patch List.

## ADJUSTING THE VOLUME

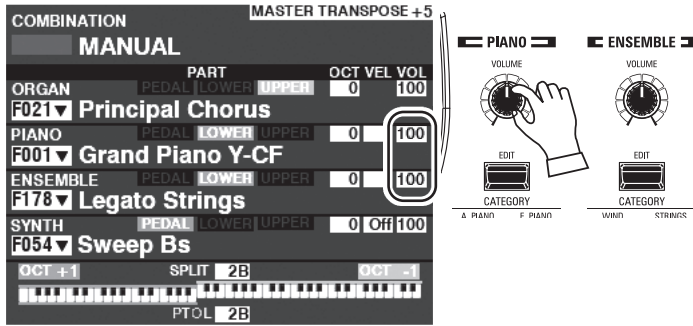

Use the [VOLUME] knob in the PIANO or ENSEMBLE Section to adjust the volume of the selected Section. For this example, use the [VOLUME] knob in the PIANO Section.

**NOTE:** You can also adjust the volume of the PIANO and ENSEMBLE Sections in the PLAY screen by moving the cursor to “VOL” (right side of screen) and using the [VALUE] knob.

**NOTE:** The word “MANUAL” is explained in more detail on page 29.

## ADJUST THE VELOCITY SENSITIVITY

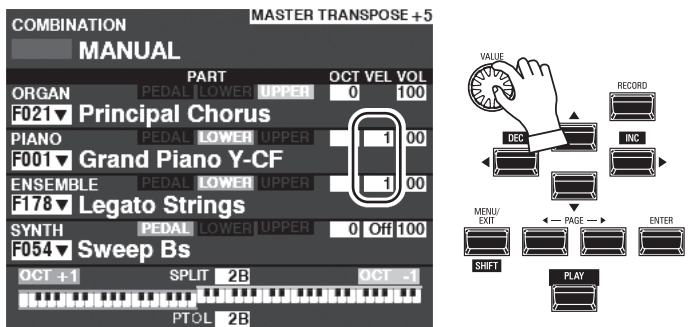

Use the [DIRECTION] buttons to move the cursor to “VEL,” and use the [VALUE] knob to select the Velocity Curve. The setting range is “Off” and “1” to “4.”

“Off” is standard organ touch - the notes sound at the same volume regardless of a light or heavy key pressure. “1” is the most exaggerated velocity curve while “4” is a gentler curve. “2” and “3” are curves in between.

**NOTE:** The Velocity setting will vary from Patch to Patch.

## CHANGING THE OCTAVE

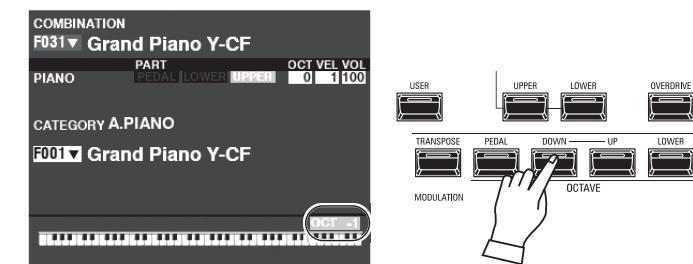

To change the Octave of the entire UPPER Keyboard (all Sections), press the OCTAVE [UP] or [DOWN] button. The display will show the current Octave setting.

**NOTE:** You can select “-2” (up to two octaves down) through +2” (up to two octaves up).

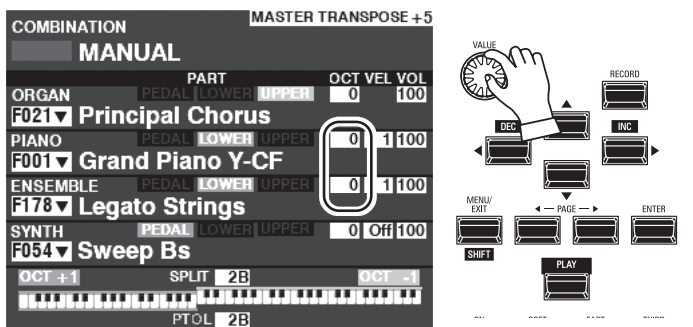

To change the Octave for the PIANO Section only, use the [DIRECTION] buttons to move the cursor to “PLAY Mode - PIANO Section - OCTAVE” and use the [VALUE] knob to change the Octave. The display will show the current Octave setting.

**NOTE:** You can select “-2” (up to two octaves down) through +2” (up to two octaves up).

### **tips** DIFFERENCE BETWEEN PIANO AND ENSEMBLE

The PIANO and ENSEMBLE Sections contain the same voices; however, to make registration of certain types of sounds easier, the inbuilt voices are separated into PIANO and ENSEMBLE Sections. The PIANO Section consists of Category buttons appropriate for keyboard and other Percussion voices, while the ENSEMBLE Section consists of voices such as Strings, Choir, Wind instruments, Synth voices and other primarily instrumental and vocal sounds. However, all inbuilt voices can be played from either the PIANO or ENSEMBLE Categories - if desired, the PIANO Section can play Strings, the ENSEMBLE Category can play Electric Piano, and so on.

# USING MONO SYNTH PATCHES

MONO SYNTH Patches are explained in detail starting below.

## ALLOCATING THE SECTION TO THE KEYBOARD

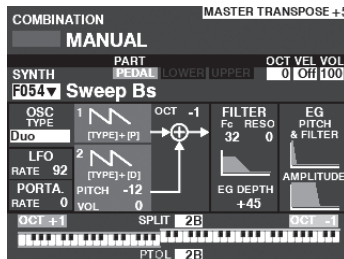
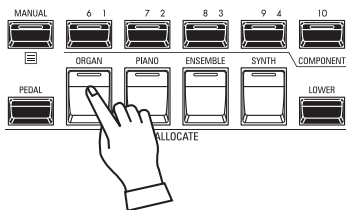

PLAY Mode (Mono Synth)

To play the MONO SYNTH on the keyboard, simply press the [MONO SYNTH] button in the [ALLOCATE] button group. The LED will light red.

**NOTE:** If only the MONO SYNTH Section is active (no other [ALLOCATE] buttons lit), the PLAY Mode will display only the MONO SYNTH Parameters.

**NOTE:** If the SPLIT button is "ON" (LED lit), the MONO SYNTH will play to the right of the SPLIT Point only.

## RECALLING A PATCH

For this example, recall MONO SYNTH Patch F048 ("4th Saw Ld").

### 1 MOVE THE CURSOR TO THE MONO SYNTH PATCH NUMBER

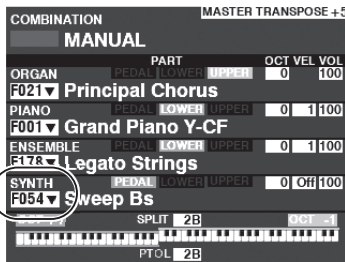

PLAY Mode (Combination)

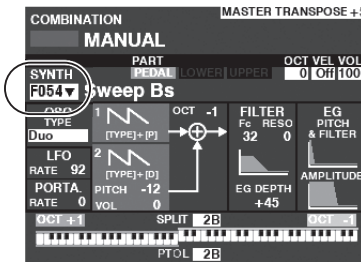

PLAY Mode (Mono Synth)

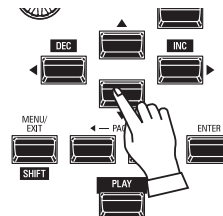

Use the [DIRECTION] buttons to move the cursor to the MONO SYNTH Patch Number.

### 2 OPEN THE PATCH LIST

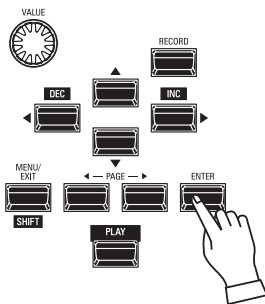
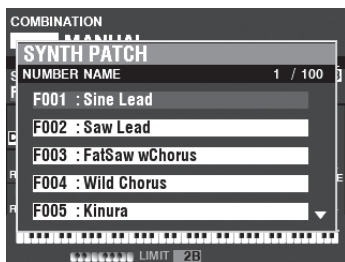

The Patch List allows you to scroll through the Patches quickly to find the Patch you want.

With the cursor highlighting the Patch Number, press [ENTER] to open the Patch List. You will see a screen similar to the one shown at the left.

### 3 SELECT THE PATCH

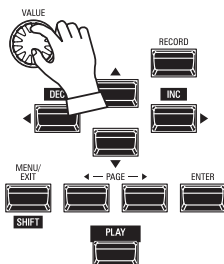
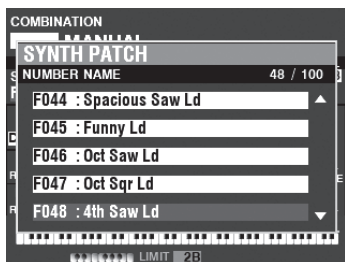

Use the [VALUE] knob to scroll through the Patch List.

For this example, when you have located Patch F048 ("4th Saw Ld"), press either the [PLAY] or [ENTER] button to return from Patch List to PLAY Mode.

**NOTE:** You can also use the PAGE [◀]/[▶] buttons to scroll through the Patch List.



# ADJUSTING THE VOLUME

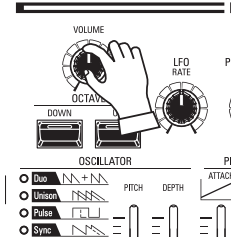
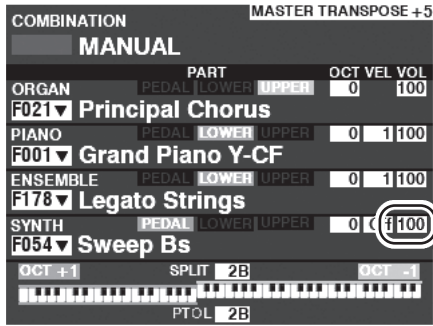

Use the [VOLUME] knob in the MONO SYNTH Section to adjust the volume.

**NOTE:** You can also adjust the volume of the MONO SYNTH Section in the PLAY screen by moving the cursor to "VOL" (right side of screen) and turning the [VALUE] knob.

**NOTE:** The word "MANUAL" is explained in more detail on page 29.

# CHANGING THE OCTAVE

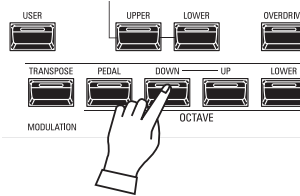
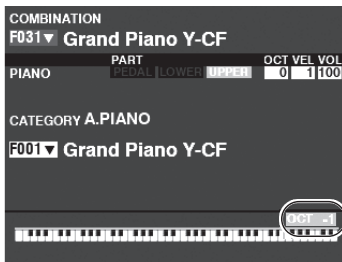

To change the Octave of the entire UPPER Keyboard (all Sections), press the OCTAVE [UP] or [DOWN] button. The display will show the current Octave setting.

**NOTE:** You can select "-2" (up to two octaves down) through +2" (up to two octaves up).

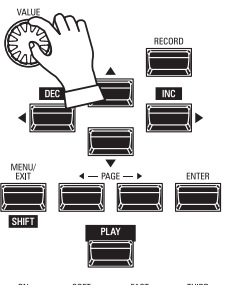
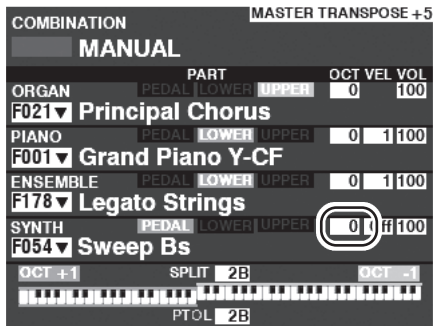

To change the Octave for the MONO SYNTH Section only, use the [DIRECTION] buttons to move the cursor to "PLAY Mode - MONO SYNTH Section - OCTAVE" and use the [VALUE] knob to change the Octave. The display will show the current Octave setting.

**NOTE:** You can select "-2" (up to two octaves down) through +2" (up to two octaves up).

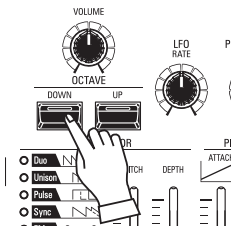
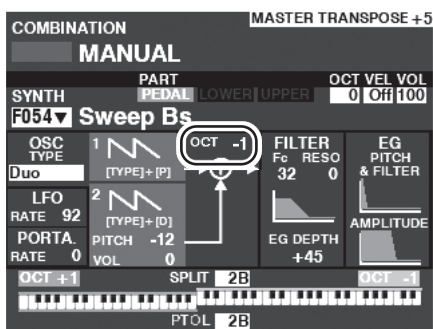

To change the Octave of the Oscillator, press the OCTAVE [UP] or [DOWN] buttons in the MONO SYNTH Section. The display will show the current Octave setting.

**NOTE:** You can select "-2" (up to two octaves down) through +2" (up to two octaves up).

# CREATING A MONO SYNTH PATCH

These pages show an example of how to create a MONO SYNTH Patch.

## SELECT [MANUAL]

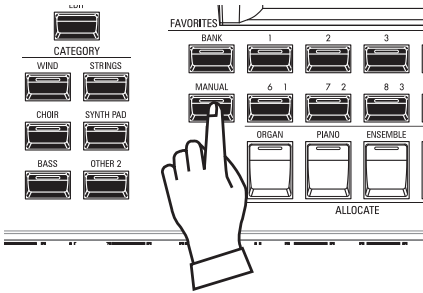

Normally, one of the [FAVORITE] buttons is “ON” (LED lit), indicating that a Combination has been selected. However, if you want to deselect Combinations and use the front panel controls entirely to control the sound, turn the [MANUAL] button “ON.” The [FAVORITE] buttons will all turn “OFF” and all sounds and features of the SK PRO will be controlled by the front panel controls as well as by the Advanced Feature settings from the Menu.

## INITIALIZE “MANUAL”

Some Menu Parameters may not be set the way you wish even if [MANUAL] is selected. If you encounter this, you can initialize the MANUAL Parameters (P. 29).

## ALLOCATE THE SECTION TO THE KEYBOARD

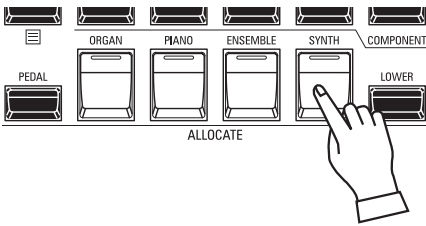

Press the [SYNTH] button in the [ALLOCATE] button group “ON.” The LED will light and the SYNTH Section will play from the keyboard.

## LOCATE THE MONO SYNTH CONTROLS

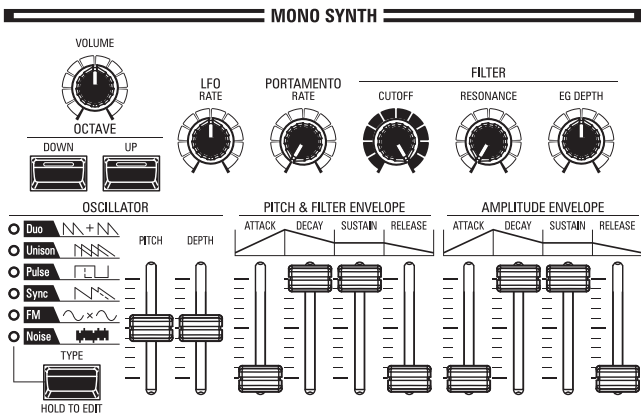

Use the controls in the MONO SYNTH portion of the Control Panel to create a MONO SYNTH Patch.

## ADJUST THE VOLUME



Use the [VOLUME] knob in the MONO SYNTH Section to adjust the volume of the MONO SYNTH. Turn to the right to increase the volume and to the left to decrease the volume.

## CHANGING THE OCTAVE

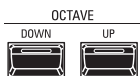

To change the Octave for the MONO SYNTH Section only, use the [DIRECTION] buttons to move the cursor to “PLAY Mode - MONO SYNTH Section - OCTAVE” and use the [VALUE] knob to change the Octave. The display will show the current Octave setting.

To change the Octave of the Oscillator, press the OCTAVE [UP] or [DOWN] buttons in the MONO SYNTH Section. The display will show the current Octave setting.

## SELECT AN OSCILLATOR

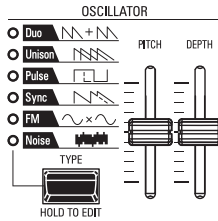

### SELECT THE WAVEFORM (OSCILLATOR TYPE)

Use the [OSC TYPE] button to select the basic waveform.

### ADJUST THE WAVEFORM (MODIFY)

Use the [PITCH] and [DEPTH] sliders to modify the Pitch and Depth of the waveform you have selected.

**NOTE:** The Oscillator Types are explained in more detail on page 53.

## SLIDE THE PITCH (PORTAMENTO)

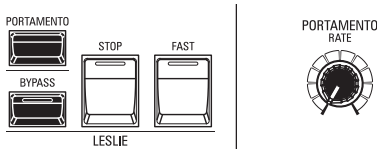

Use the PORTAMENTO [RATE] knob to adjust the rate of the Portamento.

**NOTE:** In order to hear the PORTAMENTO effect, both the [PORTAMENTO] button and the Portamento Patch Parameter must be "ON."

**tips** PORTAMENTO

"Portamento" allows you to slide smoothly from one note to another. It is often used in vocal performances or on instruments such as violin or trombone.

## ADJUST THE BRIGHTNESS (FILTER)

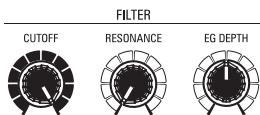

1 **[CUTOFF] knob**

This allows you to adjust the Cutoff Frequency of the filter, making the sound either brighter or more mellow.

2 **[RESONANCE] knob**

This allows you to add coloration to the sound by emphasizing the Cutoff Frequency.

3 **[EG DEPTH] knob**

This allows you to adjust the absolute level of the Cutoff Frequency of the filter.

## CHANGING THE SOUND OVER TIME (ENVELOPE)

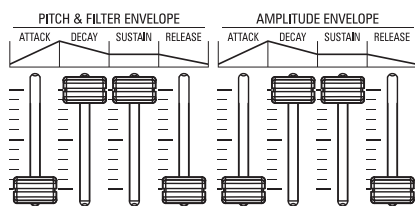

The Envelope Generator allow you to change the sound over time.

**Amplitude**..... Allows you to adjust the [AMPLITUDE] Envelope.

**Filter**..... Allows you to adjust the [PITCH&FILTER] Envelope, and set the changing depth ([EG DEPTH]) in the FILTER group.

**Pitch**..... Allows you to adjust the [PITCH&FILTER] Envelope, and set the changing depth ([PITCH EG DEPTH]) in the Patch Parameters.

1 **[ATTACK] slider**

This allows you to adjust the rate at which the value rises from zero to maximum, beginning when a key is first pressed.

2 **[DECAY] slider**

This allows you to adjust the rate at which the value changes from the Attack level to the Sustain level.

3 **[SUSTAIN] slider**

This allows you to adjust the final level when a key is depressed and held.

4 **[RELEASE] slider**

This allows you to adjust the rate at which the value decays to zero when a key is released.

## ADDING PERIODIC CHANGING (LFO)

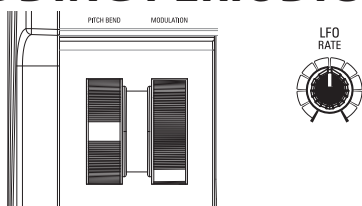

Use the LFO (Low Frequency Oscillator) to add periodic audio effects such as Vibrato or Tremolo.

**NOTE:** In the default state, you can use the [MODULATION] wheel to control the LFO. Also, you can change various characteristics of the LFO such as Waveform, etc.

## ADDING EFFECTS

You can add Multi Effects such as Chorus, Delay, Overdrive, etc., to the MONO SYNTH sound. This is explained in more detail under “Setting the Parameters” - “Mono Synth.”

## SHOWING CURRENT SETTINGS

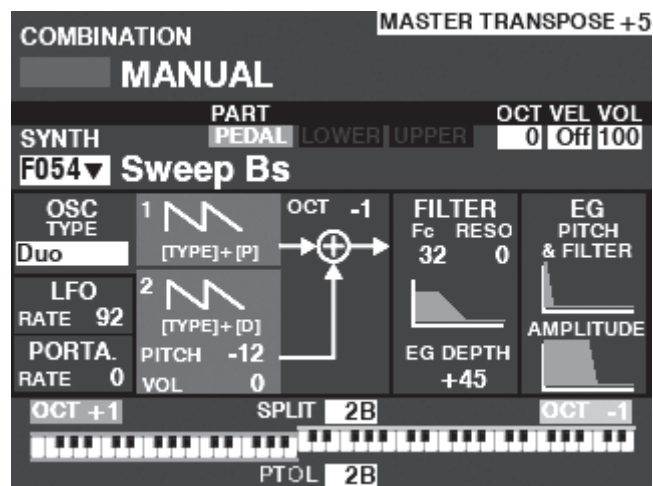

When you are in PLAY Mode, a page similar to the one shown at left will display if the MONO SYNTH Section only is selected via the [ALLOCATE] button or by repeatedly touching the [PLAY] button.

**NOTE:** The word “MANUAL” is explained in more detail on page 29.

## WHAT IS AN “OSCILLATOR?”

An **Oscillator** is the basic sound-producing unit of a synthesizer. There are several different types which produce different waveforms having different harmonic structures. These in turn can be manipulated in various ways to produce a wide variety of different musical effects.

The MONO SYNTH on the SK PRO follows the pattern of classic analog synthesizers. “Mono” is an abbreviation for “Monophonic,” meaning that this Voice Section plays one note at a time. If multiple notes are played on the keyboard, only one note will sound. The Oscillator types available on the SK PRO are explained starting on the next page.

# OSCILLATOR TYPES AND CHARACTERISTICS

The SK PRO has 6 audio oscillator settings which can be manipulated to produce a wide variety of tones. These are explained starting below.

## DUO

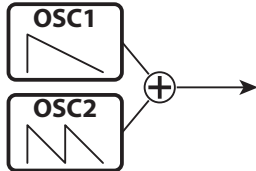

This setting utilizes two different pitched Oscillators. OSC1 sounds at “true pitch,” while OSC2 can be transposed up or down by one (1) octave in half-step increments. If the OSC2 LEVEL is set to “0,” only OSC1 will sound.

This Oscillator type is useful for Bass, Lead and “chord” effects.

Parameter	Control	Description
PITCH	PITCH	Shift the OSC2 pitch (-12 - 0 - +12 by semitones)
VOLUME	DEPTH	Volume of the OSC2 (0 - 127)
OSC1	[TYPE] + PITCH	Waveform of the OSC1 (Sawtooth, Square, Saw+Sqr)
OSC2	[TYPE] + DEPTH	Waveform of the OSC2 (same as above)

## UNISON



This setting utilizes from one to seven Oscillators, one of which can be detuned against the other. It can be used for celeste, chorus, or other purposely “out-of-tune” effects.

Parameter	Control	Description
DETUNE	PITCH	Detune depth (0 - 127)
LAYERS	DEPTH	Numbers of Oscillators (1 - 7)
OSC1	[TYPE] + PITCH	Waveform of the OSC1 (Sawtooth, Square, Saw+Sqr)
OSC2	[TYPE] + DEPTH	Waveform of the OSC2 (same as above)

## PULSE



A Pulse (or rectangular) waveform has a variable width known as the “duty cycle.” The sound can be modified by changing the pulse width or duty cycle. For example, a duty cycle of 50% will produce a clarinet-like sound while a duty cycle of 6% will yield a bright, brass-like tone quality.

Parameter	Control	Description
PW	PITCH	Pulse Width (0 - 127 as 50 - 90 [%])
MOD DEPTH	DEPTH	Depth of the Pulse Width Modulation (0 - 127)
MOD SOURCE	[TYPE] + DEPTH	Modulating source (Pitch EG, LFO, Note)

## SYNC

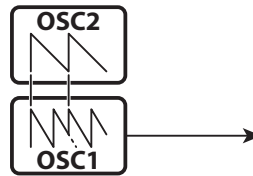

This setting utilizes two Oscillators which synchronize against each other to produce overtone effects.

Parameter	Control	Description
DETUNE	PITCH	Detune depth of the OSC1 (0 - 127)
MOD DEPTH	DEPTH	Modulation depth of the OSC1 (0 - 127)
MOD SOURCE	[TYPE] + DEPTH	Modulating source (Pitch EG, LFO, Note)

## FM



This setting utilizes two Oscillators or “operators.” OSC1 is the “carrier tone” and OSC2 is the “modulating tone. You can use this to create both “harmonic” and “inharmonic” tonal effects.

Adjusting the OSC2 pitch **down** creates wind-instrument sounds such as flute, brass, etc., while adjust the OSC2 pitch **up** is suitable for bell-like or “metallic” tones.

Setting the FB (feedback) at “Half” allows you to create string-type tones while “Full” is useful for unpitched or “noisy” tones.

Parameter	Control	Description
RATIO	PITCH	Multiply of the OSC2 (0.5, 1 - 16)
MOD DEPTH	DEPTH	Modulation depth OSC2 to OSC1 (0 - 127)
FEEDBACK	[TYPE] + DEPTH	Feedback Level (Off, Half, Full)

## NOISE

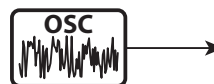

This setting creates unpitched sounds or “noise.” The sound changes from “noise” to “random pitched tones” by controlling the sampling rate.

A high sampling rate creates “seashore” type effects, a slightly lower rate yields a “noisy percussion,” and a still lower rate creates effects suggestive of a “retro science fiction movie.”

Parameter	Control	Description
RATE	PITCH	Sampling Rate (0 - 127)
MOD DEPTH	DEPTH	Modulation depth to the sampling rate (0 - 127)
COLOR	[TYPE] + PITCH	Noise color (Red, Pink, White)
MOD SOURCE	[TYPE] + DEPTH	Modulating source (Pitch EG, LFO, Note)

# COMBINING THE SECTIONS AND PARTS

You can play in a variety of different styles by allocating the 4 Voice Sections as well as the “3 PART ORGAN” feature of the ORGAN Section to each keyboard. This is explained in more detail starting below.

## SECTIONS AND KEYBOARDS

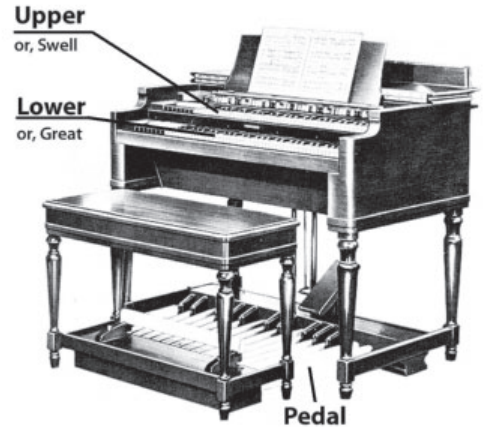
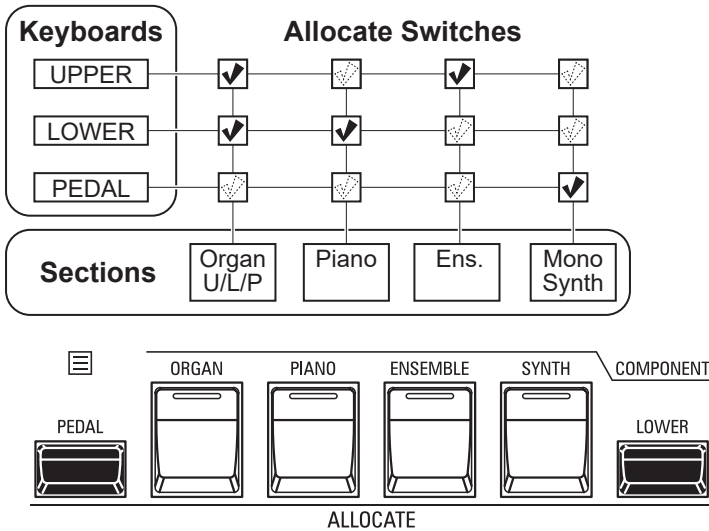

The SK PRO/SK PRO-73 contains 4 Voice Sections - ORGAN, PIANO, ENSEMBLE and MONO SYNTH. These can be played by turning the [ALLOCATE] button for each Section “ON.” In addition, the ORGAN Section has 3 Parts - UPPER, LOWER and PEDAL to replicate the performance of a classic Hammond Organ with two manuals and pedals.

### ALLOCATING THE SECTIONS

- UPPER**..... Press the [ALLOCATE] button for the desired Section “ON.” The LED will light red.
- LOWER**..... Press and Hold the [LOWER] button and turn the [ALLOCATE] button for the desired Section “ON.” The LED will light green.
- PEDAL**..... Press and Hold the [LOWER] button and turn the [ALLOCATE] button for the desired Section “ON.” The LED will light green while the [PEDAL] button is pressed.
- ALLOCATING TWO OR MORE SECTIONS TO THE SAME KEYBOARD**...Press the desired Section buttons simultaneously. The figure below shows switching on both PIANO and ENSEMBLE Sections.

**tips** [ORGAN] BUTTON LIGHTS ORANGE  
When the 3 PART ORGAN feature is used, the ORGAN Section is allocated to multiple keyboards. In this case, the LED in the [ALLOCATE] button in the ORGAN Section will light orange.

### KEYBOARD SPLIT

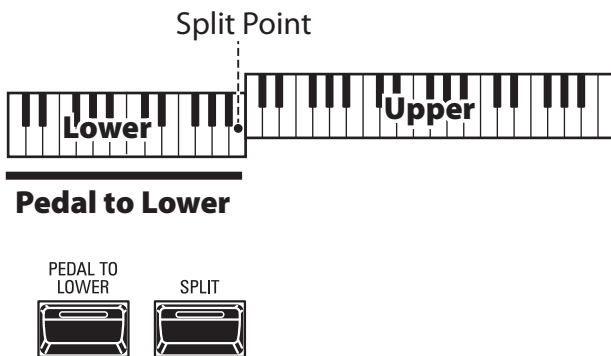

The SK PRO is a single-keyboard instrument, but by using the SPLIT feature it can be made to perform as if it were a two-manual instrument.

**tips** DIFFERENCE BETWEEN “ALLOCATE” AND “PEDAL TO LOWER”  
When you allocate a Section to Lower, it works as typically keyboard instrument as same as Upper. The PEDAL TO LOWER features for “sounding bass note with chord playing.” You can sounding the Pedal part for lowest note or root note of the chord, and ranging the Pedal part for playing by both hands on the keyboard.

## USING THE SPLIT FEATURE

To enable the SPLIT feature, press the [SPLIT] button “ON.” The LED will light. When SPLIT is active the left portion of the keyboard is referred to as LOWER while the right portion of the keyboard is UPPER.

**NOTE:** You can change the SPLIT Point. This is explained in more detail on page 78.

## CHANGING THE OCTAVE

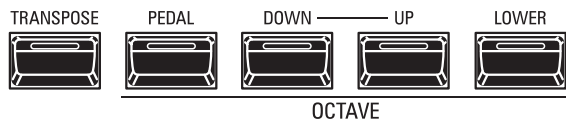

To change the Octave for each keyboard,

**UPPER**.....Press the OCTAVE [DOWN] or [UP] button.

**LOWER**.....Press and Hold the [LOWER] button and press the OCTAVE [DOWN] or [UP] button.

**PEDAL**.....Press and Hold the [PEDAL] button and press the OCTAVE [DOWN] or [UP] button.

The current Octave setting is shown in the display. The button LEDs on the buttons will light if the Octave setting is not “0.”

**NOTE:** You can set the Octave for each section. This is explained in more detail on page 78.

## PEDAL TO LOWER

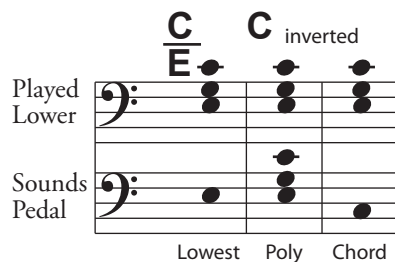

The **PEDAL TO LOWER** feature allows you to play the PEDAL Part from the LOWER Keyboard (left portion of the keyboard when [SPLIT] is active, or expanded MIDI keyboard).

To engage PEDAL TO LOWER, press the [PEDAL TO LOWER] button and lights ON.

**NOTE:** You can adjust the sounding range or condition of the PEDAL TO LOWER feature. This is explained in more detail on page 78.

## PEDAL SUSTAIN

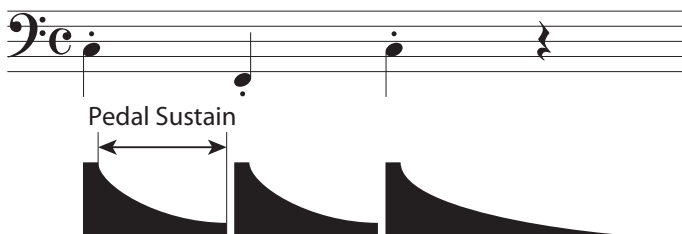

The SK PRO incorporates a feature called **Pedal Sustain**. When this feature is active, the Pedal tones will smoothly decay upon release, much in the manner of a string bass. The Pedal Sustain is controlled from the INTERNAL ZONE FUNCTION Mode.

**NOTE:** The Parameters described on this page are Combination Parameters, meaning that different settings can be Recorded to different Combinations.

# 56 ADJUSTING THE SOUND DURING PERFORMANCE

There are a number of adjustments you can make to the sound during performance. This is explained in more detail starting below.

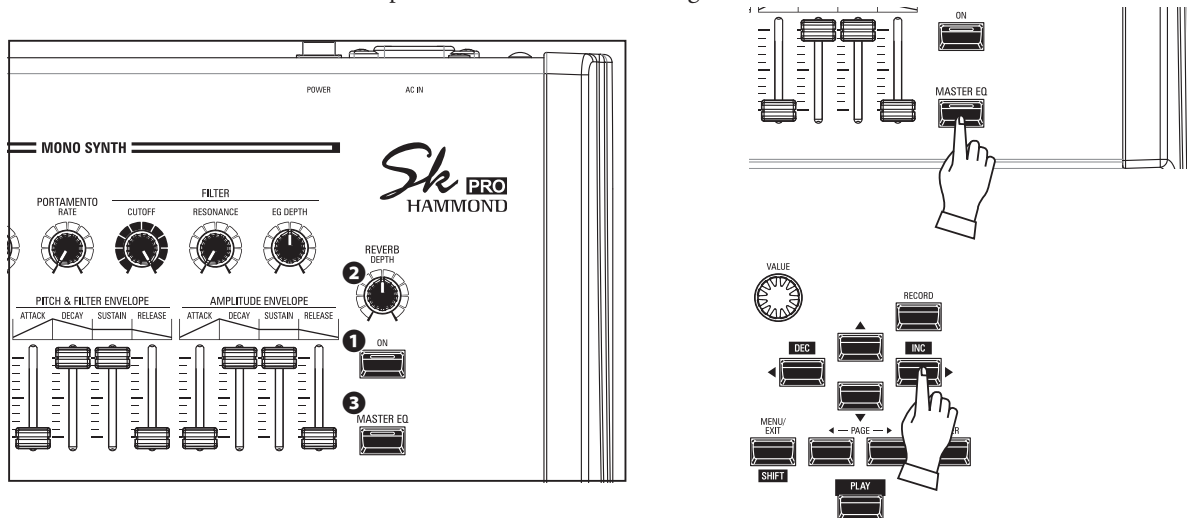

## REVERB

REVERB (or Reverberation) is the prolongation or persistence of sound caused by sound bouncing or reflecting off of hard surfaces such as floors, walls or ceilings. It is measurable by the interval of time required for the sound to decay to inaudibility after the source of the sound has been stopped.

The SK PRO has built-in Digital Reverb which allows you to simulate several different acoustic profiles representing different sizes and types of enclosures.

### 1 [REVERB ON] button (Co)

This allows you to turn Reverb “ON”(LED lit) and “OFF.”

### 2 [REVERB DEPTH] knob (Co)

This allows you to adjust the overall depth of the entire Reverb effect.

**NOTE:** You can adjust the Reverb Level for the ORGAN, PIANO, ENSEMBLE and MONO SYNTH Sections separately. This is explained in more detail on page 77.

**NOTE:** You can adjust the Reverb Type for the ORGAN and PIANO/ ENSEMBLE/MONO SYNTH Sections separately. This is explained in more detail on page 77.

**NOTE:** These Parameters are marked “Co,” meaning they are Combination Parameters.

## MASTER EQUALIZER

The Master Equalizer allows you to adjust the overall tonal quality for all Voice Sections of the entire instrument.

### 3 [MASTER EQ ON] button (Sys)

To enable the Master Equalizer, press the [MASTER EQ] button “ON.” The LED will light.

The Master Equalizer Parameters can be adjusted in the MASTER EQUALIZER Menu.

In addition, each Voice Section has an EQUALIZER Page in its FUNCTION Mode if you wish to adjust the tone quality of an individual Voice Section.

**NOTE:** This Parameter is marked “Sys,” meaning it is a System Parameter common to all Combinations and Patches.



# ADJUSTING THE MASTER EQUALIZER

The MASTER EQUALIZER Menu allows you to adjust the overall frequency response of the entire instrument.

## 1 LOCATE THE MASTER EQUALIZER MENU

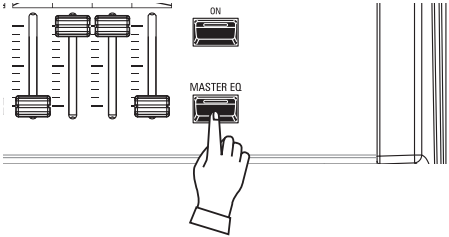

Press and Hold the [MASTER EQ] button. The display will show the “MASTER EQUALIZER” Menu Page.

## 2 SELECT THE BAND

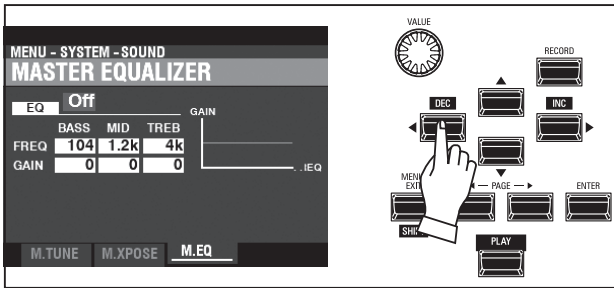

Use the [DIRECTION] buttons to move the cursor to the band you wish to adjust (BASS, MID, or TREBLE).

## 3 SELECT THE VALUE

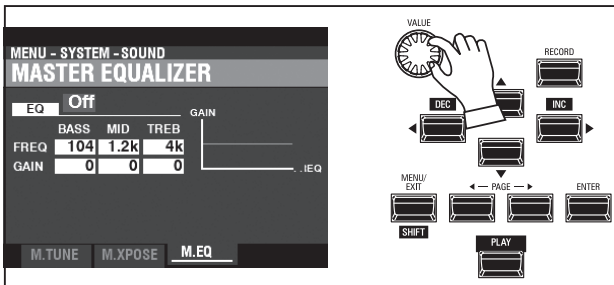

Use the [VALUE] knob to select the desired setting for the selected frequency band.

## 4 RECORD THE SETTING

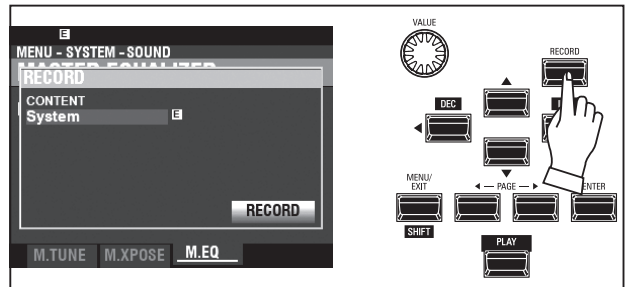

After you have made your adjustments to the Master Equalizer, you can Record your settings to be remembered the next time you turn the SK PRO Power “ON.” To do this: press the red [RECORD] button from the previous Menu Page to enter RECORD mode.

**NOTE: These are System Parameters. If edits have been made to a System Parameter, an “E” will appear to the right of the CONTENTS icon.**

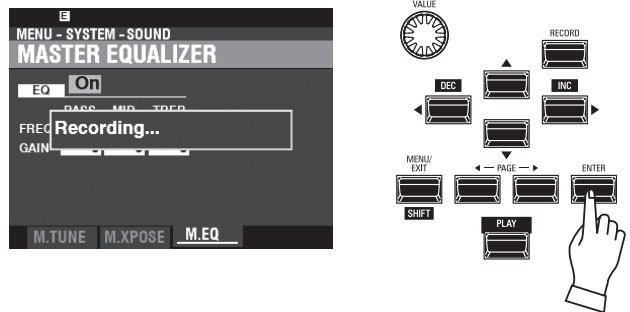

Use the [DIRECTION] [▼] button to move the cursor to the [RECORD] icon and press the [ENTER] button. The display will show “Recording...” for approximately 1 second.

## 5 RETURN TO PLAY MODE

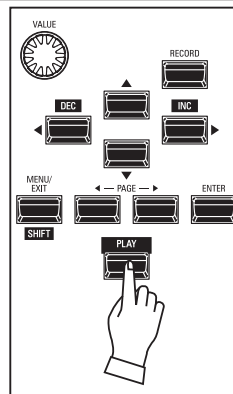

After doing the above, press the [PLAY] button to return to the PLAY Mode.

**NOTE: The MASTER EQUALIZER Parameters are System Parameters. You must Record these Parameters if you want their settings to be remembered the next time the instrument is turned “ON.” See page 141 for instructions on how to do this.**

These Parameters allows you to shift the musical key and the overall tuning of the entire instrument.

## TRANSPOSING THE ENTIRE KEYBOARD

TRANPOSE will step either up or down six (6) semitones or half-steps from the center position. This is useful if you have a piece of music written in one key but which needs to sound in another key. The TRANPOSE feature consists of the [TRANPOSE] Touch Button, plus the [DOWN] and [UP] Touch Buttons to the right of the [TRANPOSE] Touch Button. The [DOWN] Touch Button allows you to transpose lower and the [UP] Touch Button allows you to transpose higher.

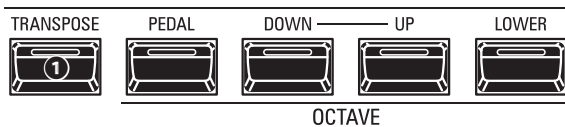

### 1 [TRANPOSE] button

- To raise the pitch, press the [UP] button, while holding down the [TRANPOSE] button.
- To lower the pitch, press the [DOWN] button, while holding down the [TRANPOSE] button.

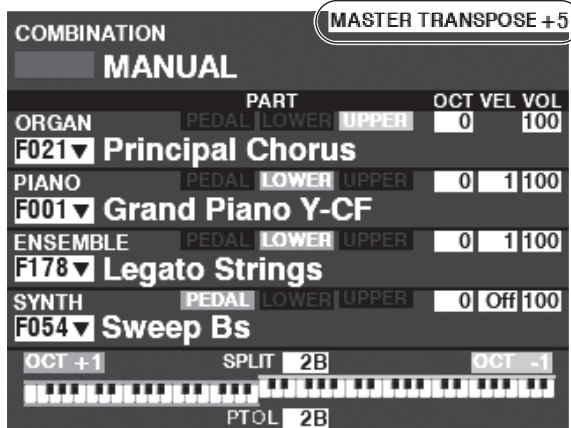

In the above example, the TRANPOSE value is set at "+5" - if a "C" key is depressed, a note five (5) half-steps higher will sound ("F").

When performing this operation, the status of the transposition is shown in the display. The [TRANPOSE] LED will light "ON" if the value is not "0."

**NOTE:** The word "MANUAL" is explained in more detail on page 29.

## WHAT IS AFFECTED BY THE TRANPOSE FUNCTION?

TRANPOSE will affect:

1. The internal sounds of the instrument.
2. MIDI IN Note Data.
3. MIDI Note Data sent OUT to the External Zones.

**NOTE:** TRANPOSE is a temporary Parameter, and is not Recorded to any Patch or Combination. When the power to the instrument is turned "OFF," it resets to 0.

**NOTE:** You can select whether Transpose changes while notes are being held or when the next note is pressed after releasing the notes being held.

# MASTER TUNE

This Parameter changes the overall tuning pitch of the entire instrument. The reference pitch is “A-440.” The selectable range is from “A-430” through “A-450.”

## ① LOCATE “MASTER TUNE”

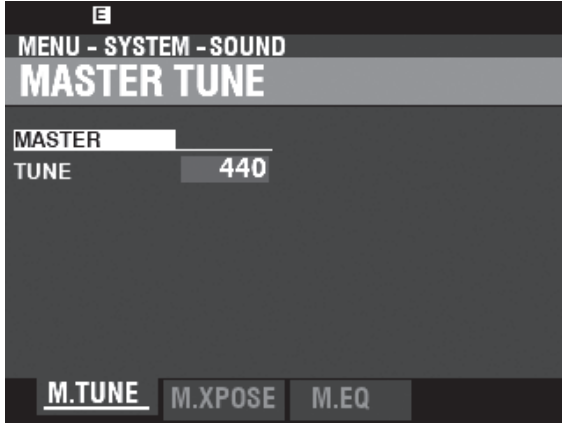

1. From the PLAY Mode, press the [MENU/EXIT] button to enter MENU Mode.
2. Press the [▶] button two times to locate the SYSTEM Menu. “SOUND” should be highlighted.
3. Press the [ENTER] button to see the MASTER TUNE Menu.

## ② SELECT THE VALUE

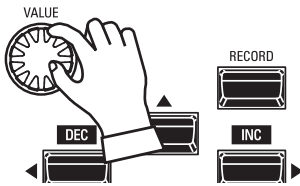

- Use the VALUE Rotary Control to the right to raise the pitch.  
Use the VALUE Rotary Control to the left to lower the pitch.

## ③ RECORD THE SETTING

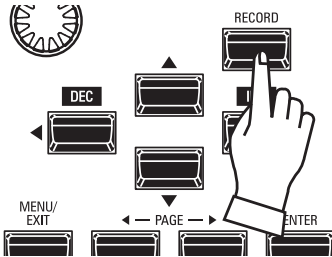

You can Record this setting to be remembered the next time the power is turned “ON.” To do this:

1. Press the red [RECORD] button from the MASTER TUNE page. You will see “System” highlighted.
2. Press the [ENTER] button. The MASTER TUNE Parameter has been Recorded.

## ④ RETURN TO PLAY MODE

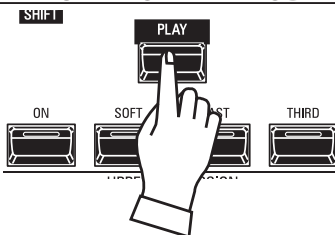

Press the [PLAY] button to return to the PLAY Mode.

# RECORDING SETTINGS

To Record the current settings to a Combination or Patch, do the following:

## ① PRESS [RECORD]

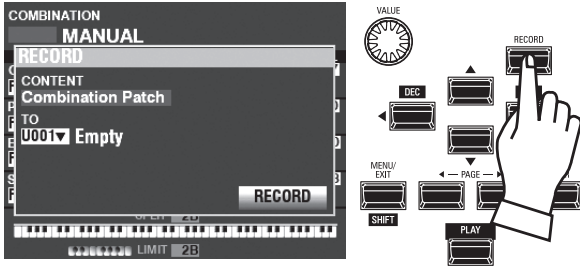

Press the red [RECORD] button at each Section or Combination page. The screen shown above will appear.

**NOTE:** The word "MANUAL" is explained in more detail on page 29.

## ② SELECT THE CONTENT

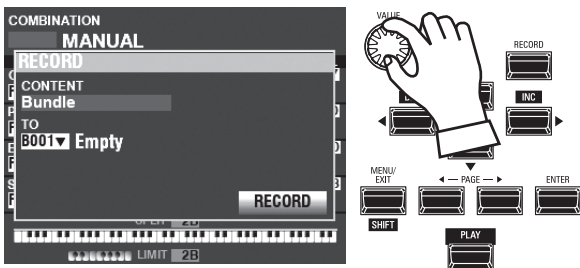

Use the [VALUE] knob to select the content to Record. For this example, select **Bundle**, which Records multiple contents simultaneously.

**NOTE:** Combinations, Patches and Voice Sections are explained starting on pages 73 and 129.

**NOTE:** If edits have been made to a Combination or Patch, an "E" will appear to the right of the CONTENTS icon.

## ③ SELECT THE NUMBER TO RECORD

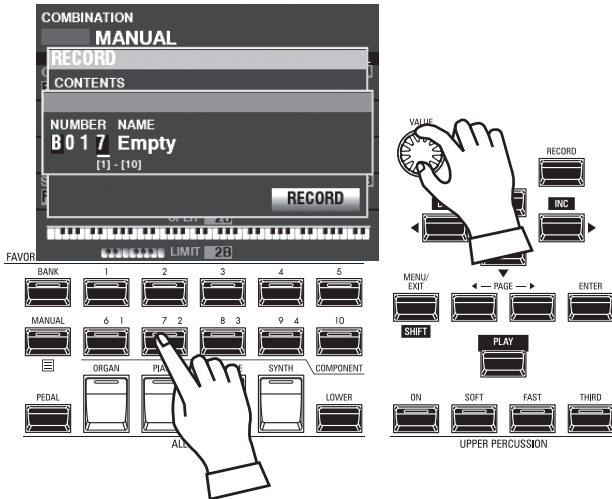

Use the [DIRECTION] [▼] button to move the cursor to "TO."

Use the [VALUE] knob to select the number to Record, or use the numbered [FAVORITE] buttons to type in the number as shown above and press the [ENTER] button.

Use the [DIRECTION] [▼] button to move the cursor to the [RECORD] icon, and press the [ENTER] button. The Naming screen will display.

## ④ NAME THE CUSTOM SETTING

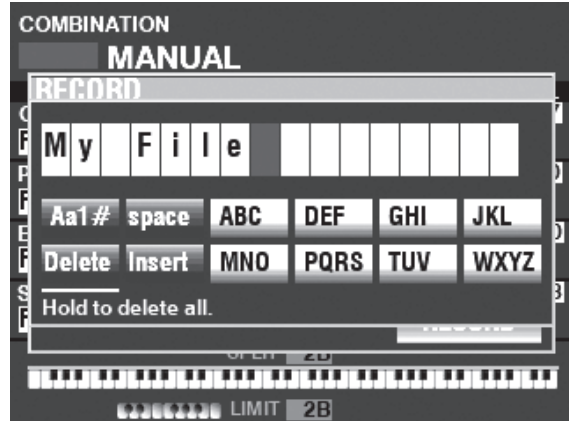

Enter the Name.

- [Aa1]#..... Changes the character type.
- [1] - [10] ..... Selects the highlighted character.
- [Insert] ..... Inserts a space at the cursor.
- [Delete] ..... Deletes a letter at the cursor.
- [VALUE] ..... Changes the letter at the cursor.

After you are finished Naming, press the [ENTER] button. The message shown below will display for approximately 1 second:

Recording...

**NOTE:** Do not turn the power "OFF" while the above message is displaying.

**NOTE:** If you DO NOT wish to Record, press the [MENU/EXIT] or [PLAY] button instead of the [ENTER] button.

## ⑤ RETURN TO PLAY MODE

Press the [PLAY] button to return to the PLAY Mode.

### tips RECORDING METHOD

Each portion of the SK PRO is Recorded separately. **Combination** Records Combination Parameters and Voices. **Bundle** Records Combination Parameters as well as ORGAN and MONO SYNTH Patches simultaneously. **Patch** Records changes to individual Patches and **Custom** Records Tone Wheel Organs, Leslie Cabinets, Pedal Registrations and Pipe Organs. If you wish to Record the entire contents of the instrument, you can save them as a Setup.

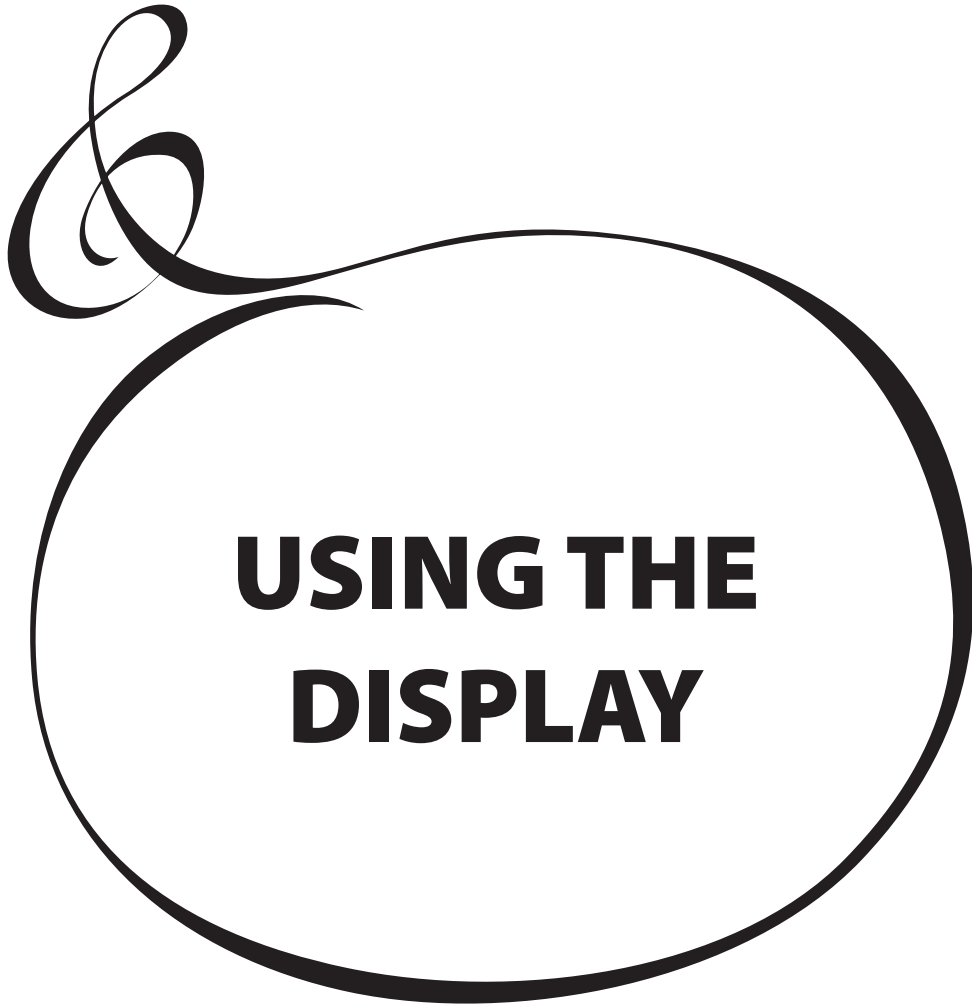

# USING THE DISPLAY

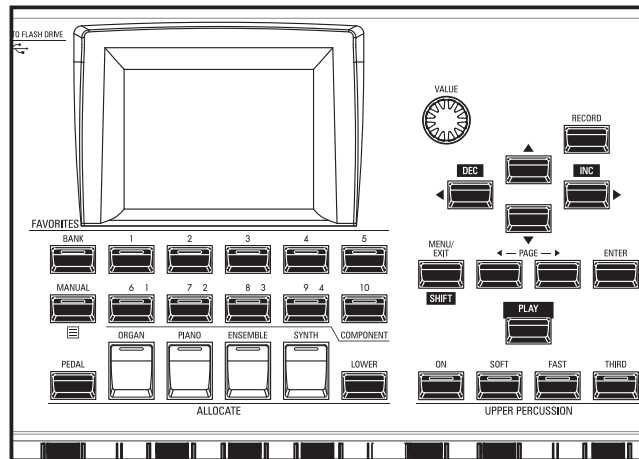

The display has three (3) Modes - PLAY Mode, MENU Mode and FUNCTION Mode. The next pages explain how to read the display in each Mode.

## PLAY MODE

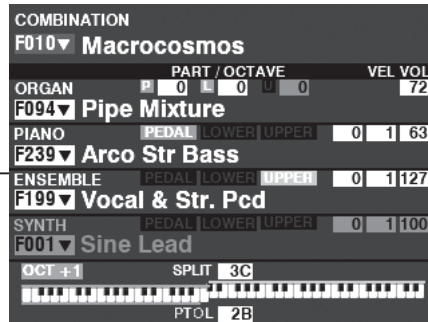

The PLAY Mode allows you to see or modify the current basic settings such as Drawbar settings, Combination Numbers, Patch Numbers and other information.

## MENU MODE

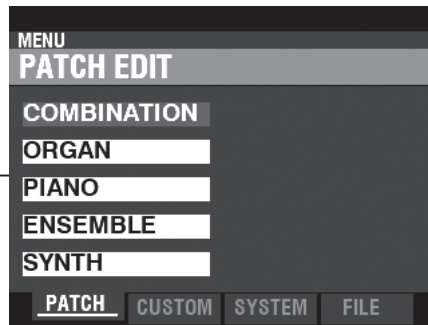

The MENU Mode allows you to see the different FUNCTION Modes where you can customize the instrument.

## FUNCTION MODE

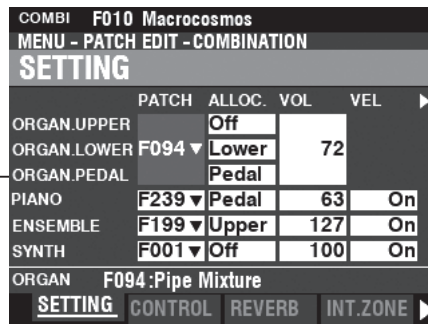

The FUNCTION Mode allows you to change specific Parameters within each MENU Mode.

The PLAY Mode is the normal performance mode. The information necessary for ordinary performance will be displayed.

## TO LOCATE THIS MODE:

The PLAY Mode is automatically displayed when the instrument is first powered “ON” and the opening screen disappears. Press the [PLAY] button if another mode is displayed.

## PLAY MODES

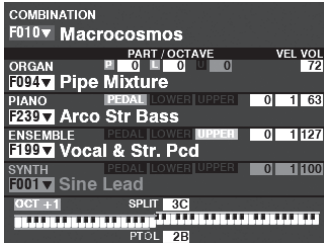

General

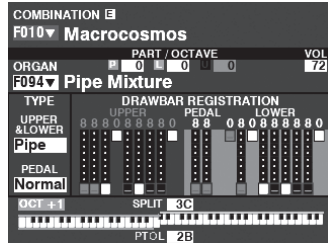

ORGAN Section



PIANO Section / ENSEMBLE Section

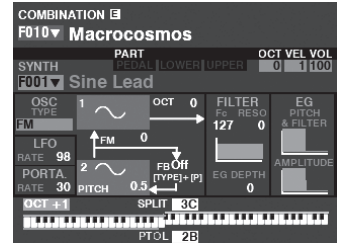

MONO SYNTH Section

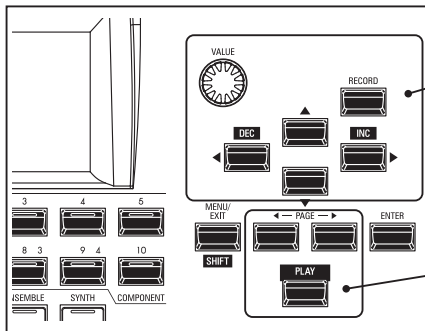

Each PLAY Mode allows you to select the Combinations or Patches and adjust the Parameters most frequently used.

The PLAY Modes are selected by the [PLAY] or [PAGE] [◀/▶] buttons.

## HOW TO READ THE DISPLAY (COMBINATION)

When two or more Voice Sections are “ON,” the Names will be highlighted in the display. If a Voice Section is “OFF” ([ALLOCATE] button LED not lit), the Voice Name will still display but will be “greyed out.” In addition, Parameters such as Octave, etc., will only display if their values are different from their default settings.

## HOW TO READ THE DISPLAY (ORGAN SECTION)

If only the ORGAN Section is used (ORGAN [ALLOCATE] button "ON"), a screen similar to the one below will display.

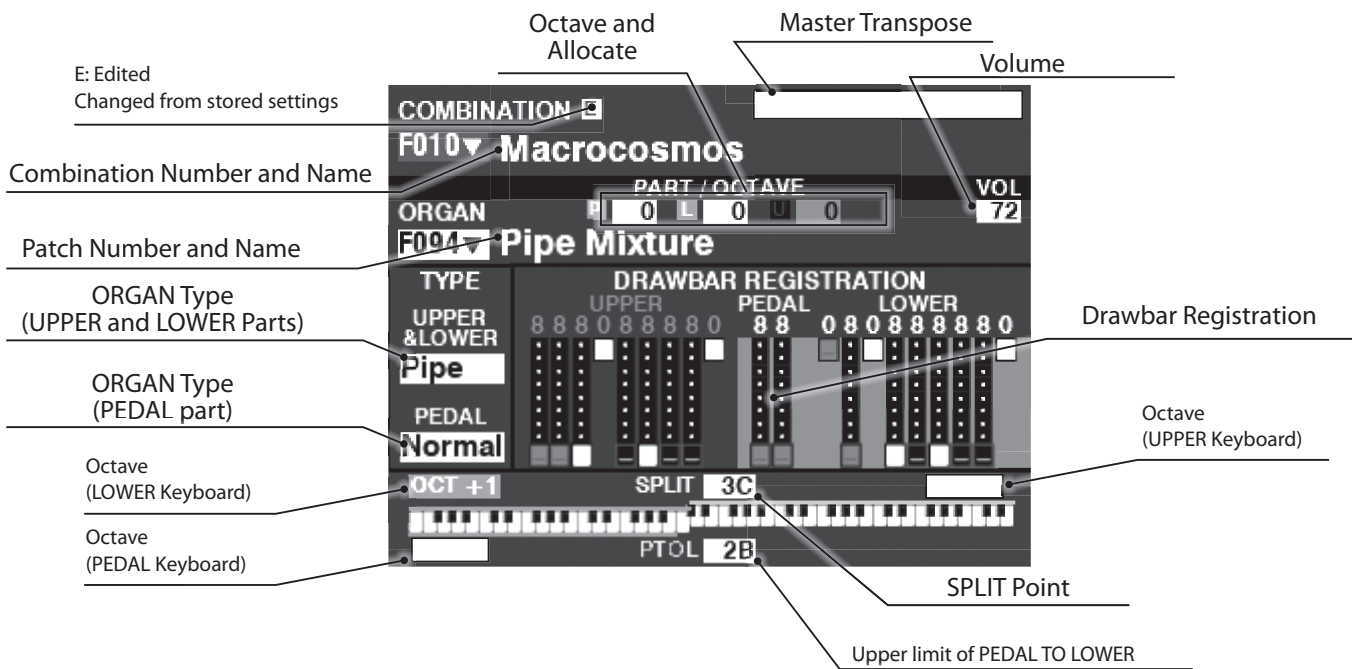

## HOW TO READ THE DISPLAY (PIANO/ENSEMBLE SECTION)

If either the PIANO or ENSEMBLE Section only is used (PIANO or ENSEMBLE [ALLOCATE] button "ON"), a screen similar to the one below will display.

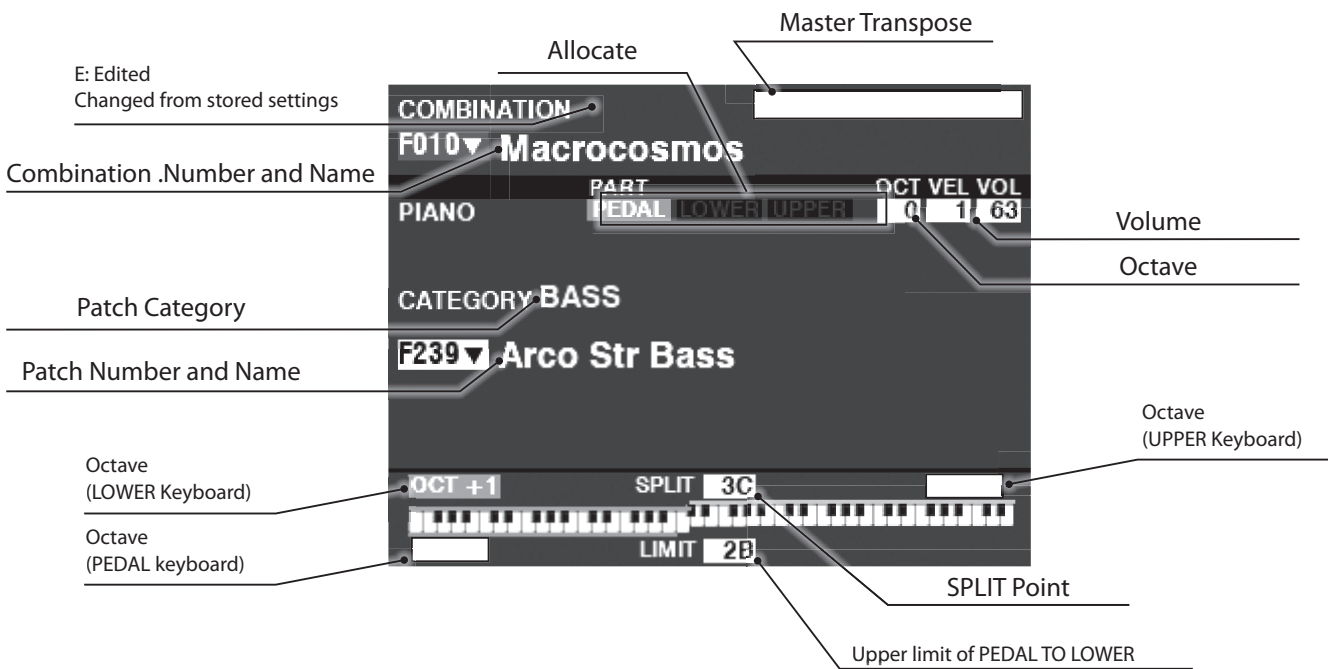



# HOW TO READ THE DISPLAY (MONO SYNTH SECTION)

If only the MONO SYNTH Section is used (SYNTH [ALLOCATE] button “ON”), a screen similar to the one below will display.

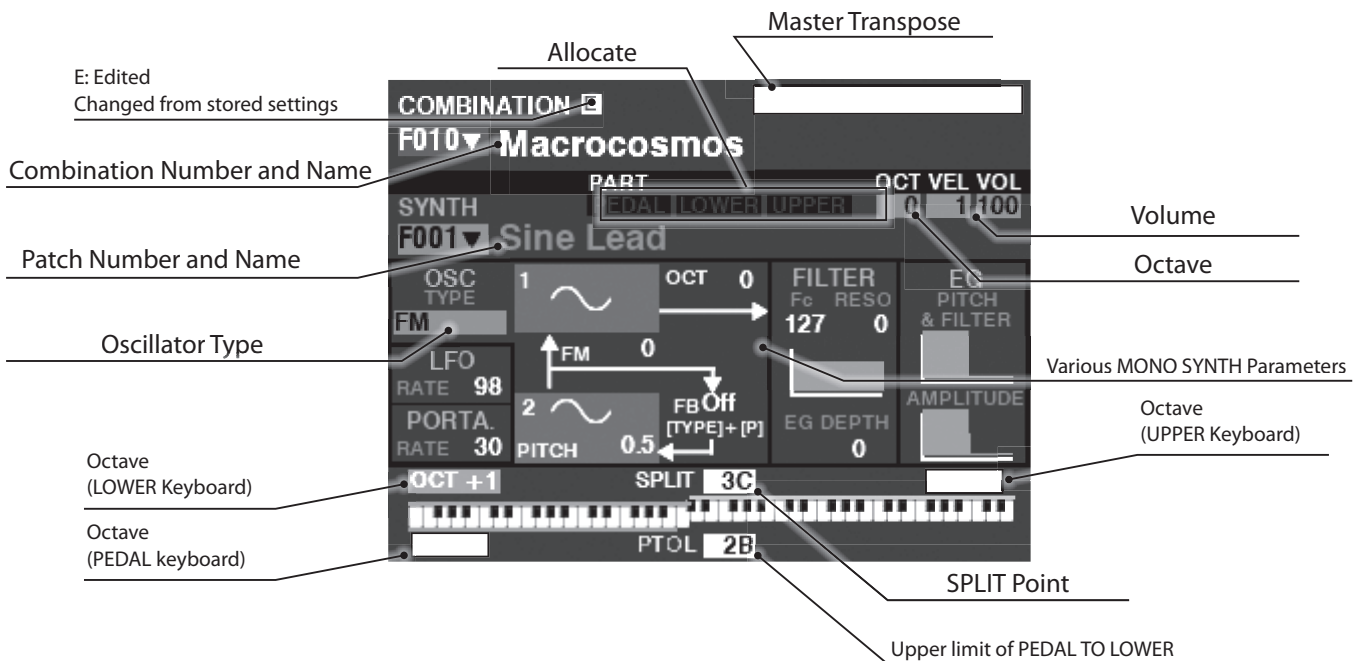

# APP (APPLICATION) MENU

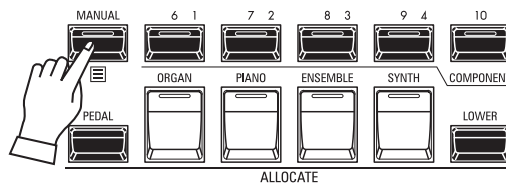
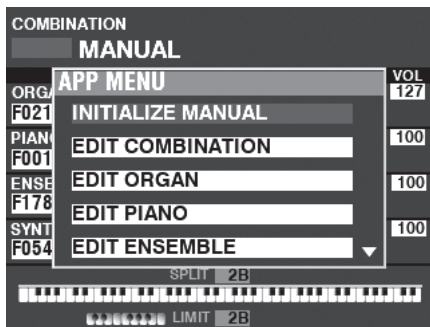

The APP (Application) Menu allows you to select various Menu Pages quickly. To display the APP Menu:

1. Select a FUNCTION Mode.
2. Press and Release the [=] button. The following Menu options will display:
  - INITIALIZE [MANUAL]** ..... Initialize the MANUAL Parameters.
  - EDIT COMBINATION**..... Enter the Combination edit page.
  - EDIT ORGAN** ..... Enter the Organ edit page.
  - EDIT PIANO** ..... Enter the Piano edit page.
  - EDIT ENSEMBLE** ..... Enter the Ensemble edit page.
  - EDIT SYNTH**..... Enter the Mono Synth edit page.
  - DELETE COMBINATION**..... Delete selected Combination.

To select an option:

1. Use the [DIRECTION] [▲]/[▼] buttons to highlight the option you want.
2. Press the [ENTER] button to select the desired option.

**NOTE: The word “MANUAL” is explained in more detail on page 29.**

**tips APP MENU**

The number of options displayed by the APP Menu depends on how many Voice Sections are active. For example, if only the ORGAN Section is active (ORGAN [ALLOCATE] button “ON”), the other Voice Menus will not display. To see the APP Menu as it appears at the left, turn all four Voice Sections “ON” ([ALLOCATE] LED’s lit).

# MENU MODE

As explained earlier, the MENU Mode allows you to see the different FUNCTION Modes where you can customize the instrument.

## TO LOCATE THIS MODE:

Press the [MENU/EXIT] button.

The MENU Mode has four Pages. Use the PAGE [◀]/[▶] buttons to scroll through the Pages, select the item using the [DIRECTION] buttons, and [ENTER] button to enter the desired FUNCTION Mode.

## HOW TO READ THE DISPLAY

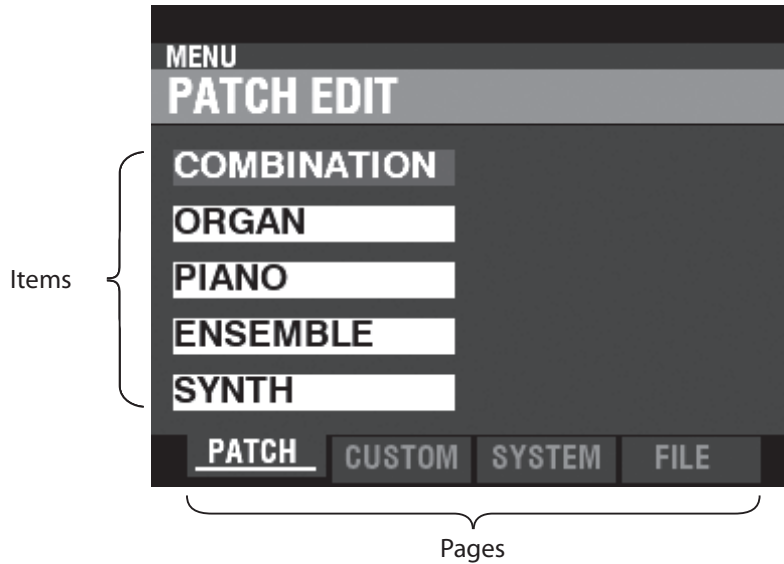

## OPERATION IN THIS MODE

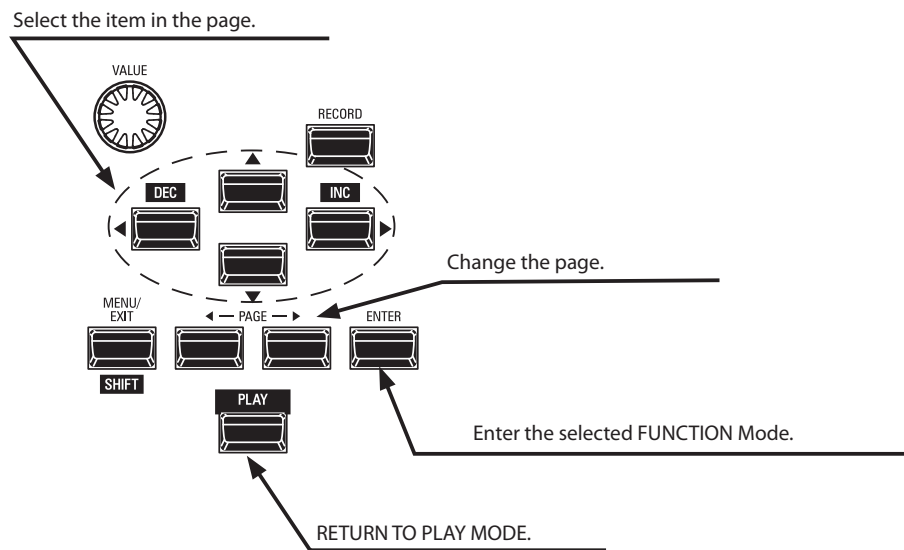

## MENU MODE CONTENTS

### PATCH

---

1. **COMBINATION (P. 74)**  
This allows you to edit the current Combination.
2. **ORGAN (P. 80)**  
This allows you to edit the current registration in the ORGAN Section.
3. **PIANO (P. 90)**  
This allows you to edit the currently selected voice in the PIANO Section.
4. **ENSEMBLE (P. 90)**  
This allows you to edit the currently selected voice in the ENSEMBLE Section.
5. **SYNTH (P. 100)**  
This allows you to edit the current MONO SYNTH Parameters.

### CUSTOM

---

1. **TONE WHEEL (P. 120)**  
This allows you to edit the characteristics of the Tone Wheel Organ.
2. **PEDAL REG. (P. 123)**  
This allows you to edit the harmonics used by the Pedal Drawbars of the Tone Wheel Organ.
3. **LESLIE (P. 124)**  
This allows you to edit the inbuilt digital Leslie.
4. **PIPE (P. 126)**  
This allows you to select and edit each Pipe Organ Stop.

### SYSTEM

---

1. **SOUND (P. 130)**  
This allows you to adjust Master Tune, Transpose, and Master Equalizer.
2. **AUDIO (P. 131)**  
This allows you to adjust the audio configuration between Voice Sections and output jacks.
3. **CONTROL (P. 132)**  
This allows you to adjust the Parameters for the various controllers such as Foot Switch, Expression Pedal, Display and Keyboard.
4. **PATCH LOAD (P. 138)**  
This allows you to select which contents are loaded when a Combination is selected.
5. **FAVORITE (P. 139)**  
Allows you select and edit Favorites.
6. **MIDI (P. 156)**  
This allows you to adjust MIDI Channels, and various messages for the MIDI port and the USB MIDI.
7. **GLOBAL (P. 140)**  
This allows you to adjust the Auto Power Off time and select USB Mass Storage.
8. **DELETE (P. 142)**  
This allows you to delete "U" (User) contents.
9. **DEFAULT (P. 143)**  
This allows you to initialize all or part of the SK PRO to factory settings.

### 10. INFORMATION (P. 144)

This allows you to see which jacks on the Rear Panel are currently active and which version of software is currently installed. Also allows you to update the software.

### FILE

---

1. **LOAD (P. 165)**  
This allows you to Load Setups, Patches or Custom File from either an external device such as a USB Flash drive or the Internal Memory into the instrument.
2. **SAVE (P. 164)**  
This allows you to Save Setups, Patches, Custom Files, etc., either to an external device such as a USB Flash drive or the Internal Memory into the instrument.
3. **DELETE (P. 166)**  
This allows you to Delete Setups, Patches or Custom Files, either from an external device such as a USB Flash drive or from the Internal Memory of the instrument.
4. **FORMAT (P. 161)**  
This allows you to initialize either an external device such as a USB Flash drive or the Internal Memory of the instrument.

# FUNCTION MODE

The FUNCTION Mode allows you to see and adjust the various Parameters. This is explained in more detail starting below.

## HOW TO READ THE DISPLAY

Section, E(Edited) Mark, Combination/Patch Number and Name.

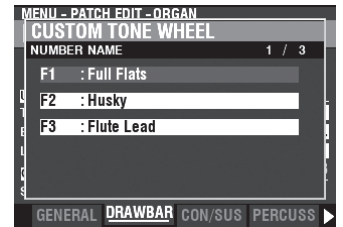
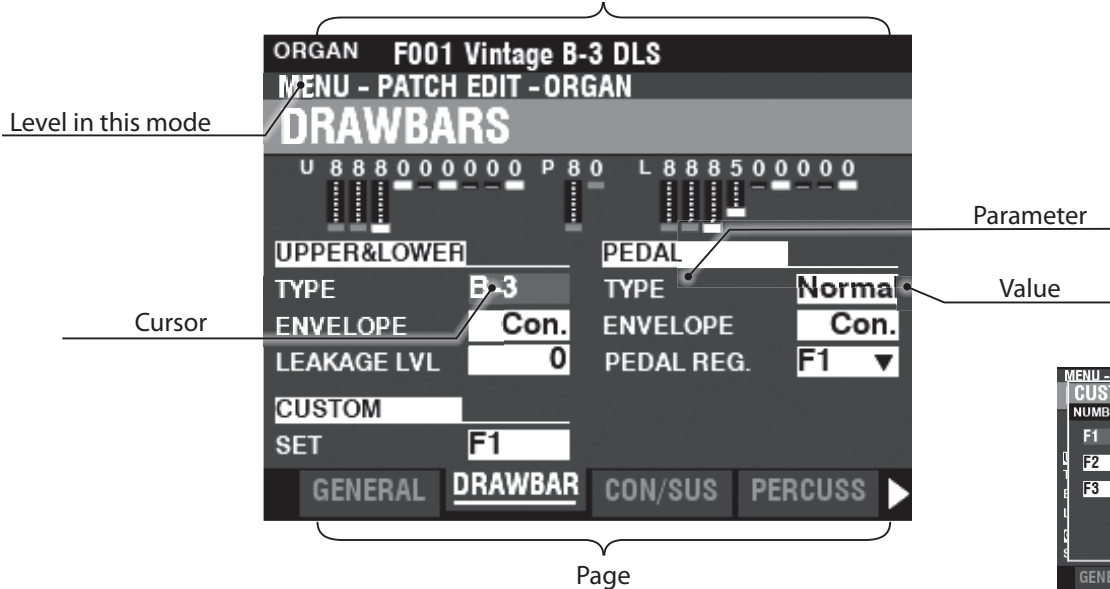

### tips CHANGING PARAMETERS

The "▼" to the right indicates more than one choice is available.

The following is an example of how to change Parameters to your liking. This example shows how to select a Custom Tone Wheel Set.

To select a Custom Set:

1. Move the cursor to CUSTOM and press [ENTER]. You will see the window shown above.
2. Use the VALUE knob or the [DEC]/[INC] buttons while holding the [SHIFT] button to select the desired Custom Set.
3. Press the [ENTER] button to select the desired Custom Set. The above window will close after you have made your selection.

## OPERATION IN THIS MODE

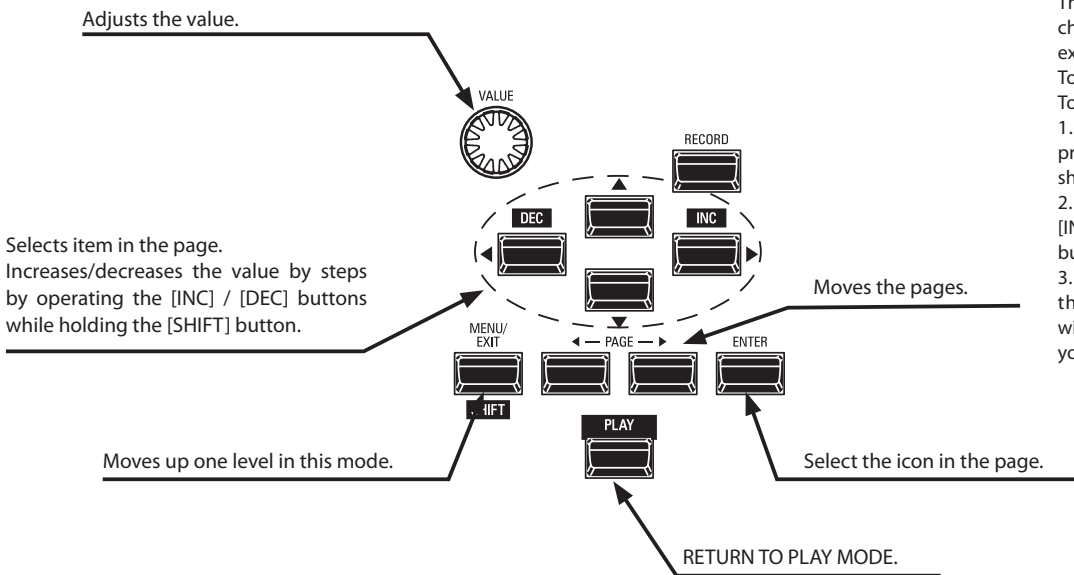

## APP (APPLICATION) MENU

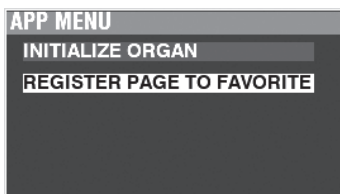

The PLAY Mode and several of the FUNCTION Mode Pages contain an additional APP Menu which you can use to access various functions quickly.

Press the [≡] button to see the APP Menu for the FUNCTION Modes.

Press and Release the [≡] button to see the APP Menu in PLAY or MANUAL Mode.

To select an item in an APP Menu:

1. Use the [▲]/[▼] buttons to highlight the option you want.
2. Press and Release the [ENTER] button to select the desired option.

## EXAMPLE OF OPERATION

### ① GO TO THE MENU MODE

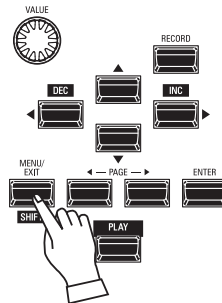
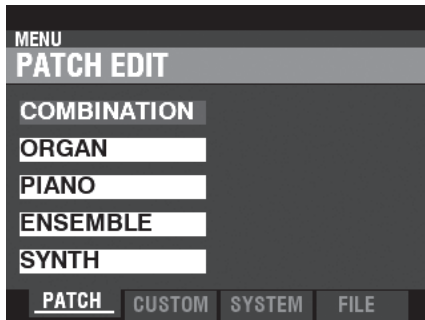

This example will show you how to adjust the Percussion Decay Time when the [FAST] button is selected.

Press the [MENU/EXIT] button. The MENU Mode will appear.

### ② MOVE THE PAGE IN THE MENU MODE

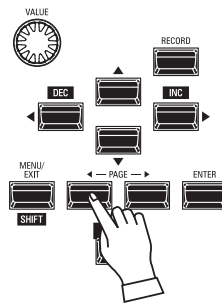
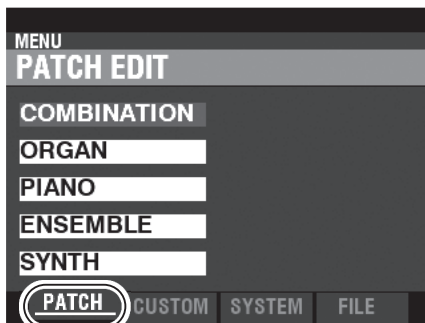

Use the [PAGE] [◀]/[▶] buttons to select the different Pages in each Menu.

For this example, the PATCH Edit Menu is already displayed so it is not necessary to touch either of the [PAGE] [◀]/[▶] buttons.

### ③ SELECT THE ITEM IN THE PAGE

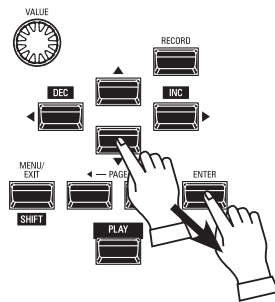
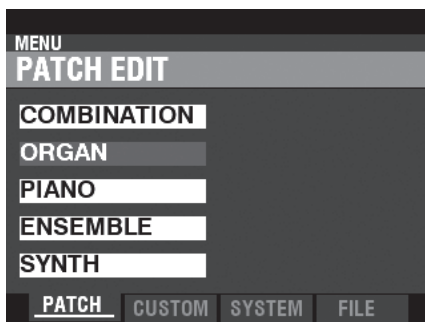

Use the [DIRECTION] buttons to select the item to edit.

For this example, press the [▼] button to select “ORGAN.”

Press the [ENTER] button to select each FUNCTION Mode. For this example, touch [ENTER] after selecting “ORGAN” above.

### ④ MOVE THE PAGE IN THE FUNCTION MODE

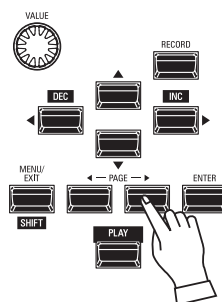
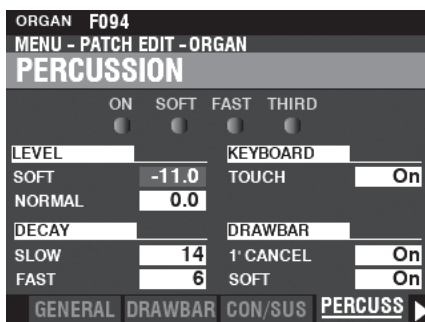

Use the [PAGE] [◀]/[▶] buttons to select the individual FUNCTION Mode Page you want to edit.

For this example, press the [▶] button three times to select the PERCUSS (Percussion) Menu Page.

⑤ MOVE THE CURSOR TO THE PARAMETER

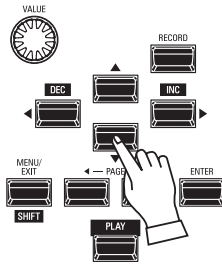
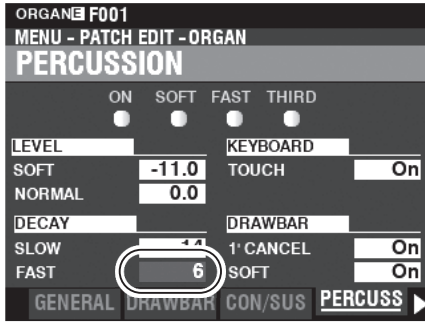

Use the [DIRECTION] buttons to move the cursor to the Parameter you wish to adjust. For this example, select “DECAY FAST.”

⑥ CHANGE THE VALUE

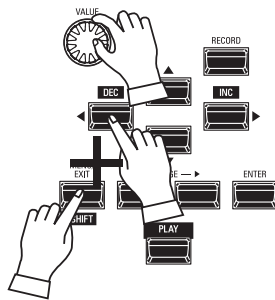
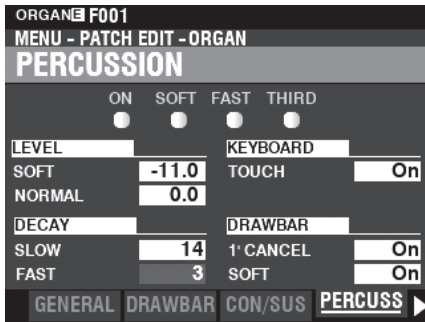

Use the [VALUE] knob to change the selected value. For this example, decrease the value by turning the [VALUE] knob to the left.

**NOTE:** You can also change values by using the [DEC] / [INC] buttons while pressing and holding the [SHIFT] button.

**NOTE:** To change other Parameters, repeat steps 1 through 6 above.

⑦ RECORD THE PATCH

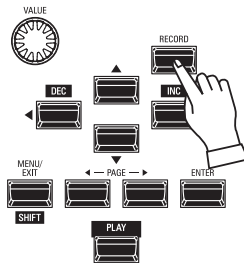
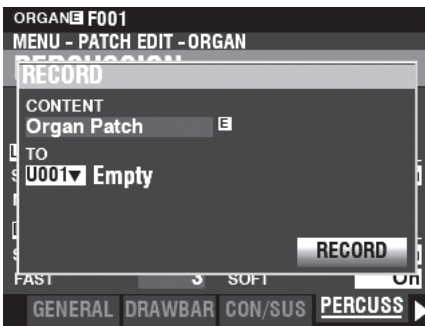

These settings are “temporary,” and will not be remembered if another Patch or Combination is selected, or if the instrument is turned “OFF.” To Record your settings:

1. Press the red [RECORD] button. You will see the selected item appear in the display (“Organ Patch” in this example).
2. Press the “▼” button two times to select RECORD and press the [ENTER] button. Your settings have been Recorded.

⑧ RETURN TO PLAY MODE

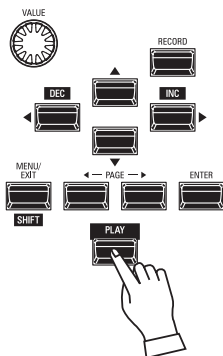
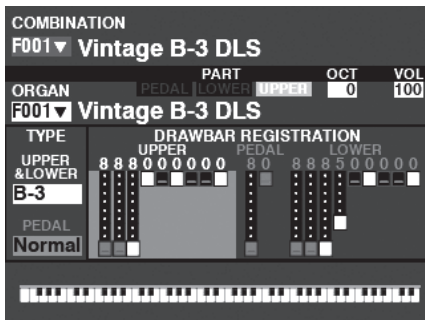

Press the [PLAY] button to return to the PLAY Mode.

To make programming quicker and easier, many of the buttons on the Control Panel can be used to access the FUNCTION Mode associated with that button instantaneously. Pressing and holding any of the buttons on the Control Panel automatically "shortcuts" the display to the related FUNCTION Mode.

## SHORTCUT EXAMPLE:

### LOCATE THE PERCUSSION FUNCTION MODE

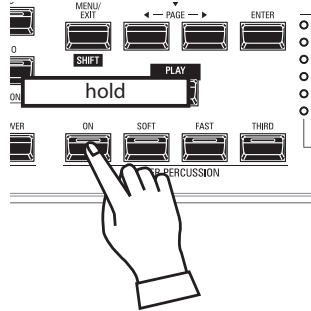
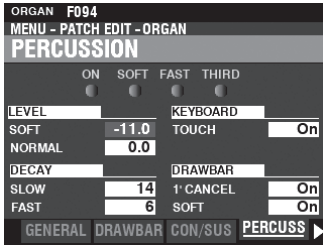

If you wish to edit the Percussion settings, Press and Hold any of the four Percussion buttons ([ON], [SOFT], [FAST], or [THIRD]) and the display will immediately show the Percussion FUNCTION Mode.

**NOTE:** You can change the Display Shortcut time. This is explained in more detail on page 139.

## IF YOU FREQUENTLY USE A CERTAIN PAGE...

You can assign a frequently-used FUNCTION Mode to one of the [FAVORITE] buttons for immediate access, even if that particular FUNCTION Mode is not normally accessible via a Shortcut.

## REGISTER

### ① LOCATE THE PAGE

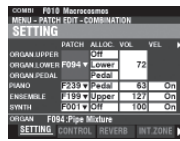

Press the [MENU\EXIT] button to enter MENU Mode and use the [DIRECTION] and [PAGE] buttons to locate the specific FUNCTION Mode you want.

### ② SET THE FAVORITE NUMBER TO LOAD THE PAGE

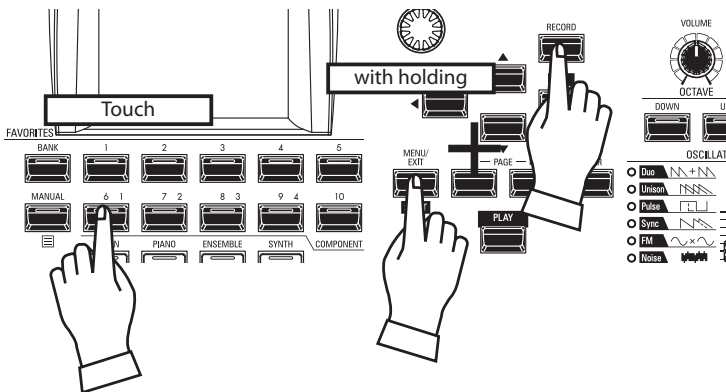

1. Touch and Hold the [SHIFT] and [RECORD] buttons together.
2. While holding the two buttons, touch any of the numbered [FAVORITE] buttons. The display will show, "Recording Assign" for approximately 1 second.

## DISPLAY THE RECORDED PAGE

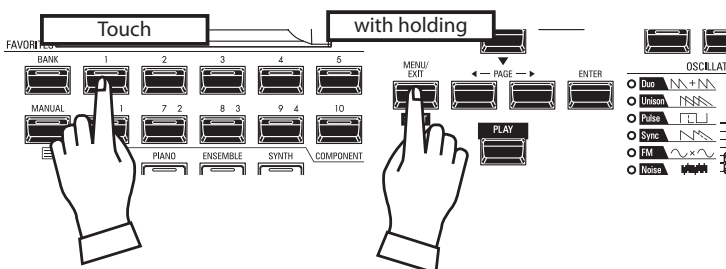

To display the Recorded Page, Press and Hold the [SHIFT] button and press the numbered [FAVORITE] button.

# LOCKING THE DISPLAY

You can Lock the display in order to prevent accidental changes during live performance, or when more than one musician will be using the same instrument.

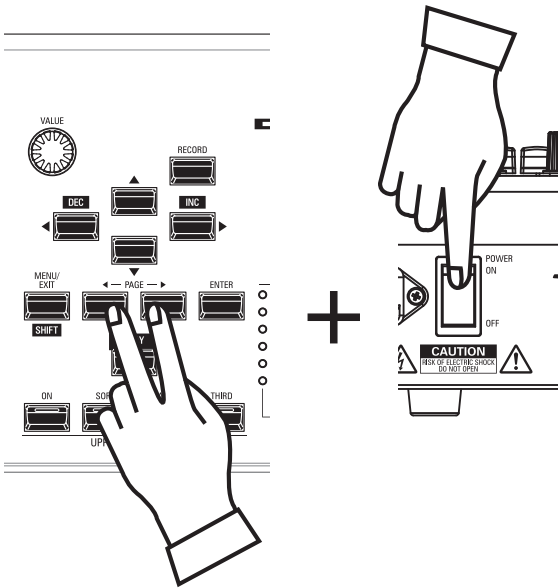
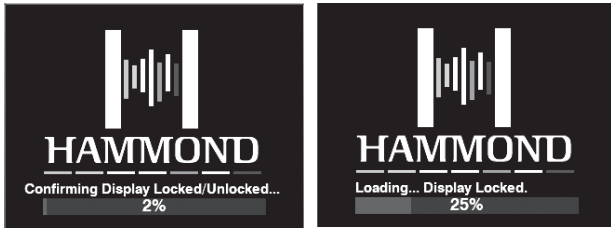

To Lock the display, do the following:

1. With the SK PRO power "OFF," Press and Hold the two PAGE [◀][▶] buttons.
2. While holding the PAGE buttons, turn the SK PRO power "ON." Continue to hold the PAGE buttons until "Confirming Display Locked/Unlocked" is shown in the display.

After approximately 5 seconds, "Display Locked" will show at the bottom of the display. You can then release the PAGE buttons.

To Unlock the display, follow the above two steps. You will see "Display Unlocked" in the display.

When the display is Locked:

1. [MENU/EXIT] is disabled.
2. [RECORD] is disabled.
3. The "Shortcut" feature is disabled.
4. Combinations and Patches can still be recalled.

**NOTE: If the display is Locked, you will see a message in the display when the instrument is first turned "ON:" "Loading...Display Locked."**

**NOTE: If the display is Locked, holding the red [RECORD] button and applying power will not Unlock it. Follow the procedure described above to Unlock the display.**



A decorative graphic featuring a large, stylized ampersand (&) on the left side. A thick black line starts from the bottom of the ampersand, curves around the top and right, and then forms a large circle. Inside this circle, the words "EDITING" and "PARAMETERS" are written in a bold, black, sans-serif font, stacked vertically.

**EDITING  
PARAMETERS**

# COMBINATION

As explained previously, the four sound-producing Sections of the SK PRO - ORGAN, PIANO, ENSEMBLE and MONO SYNTH - along with other Parameters such as Control Panel settings, etc., can be combined into a single unit called a **Combination**. This FUNCTION Mode allows you to adjust Combination Parameters which are included in a Combination.

## TO LOCATE THIS MODE:

[MENU/EXIT] - PATCH - COMBI - [ENTER]

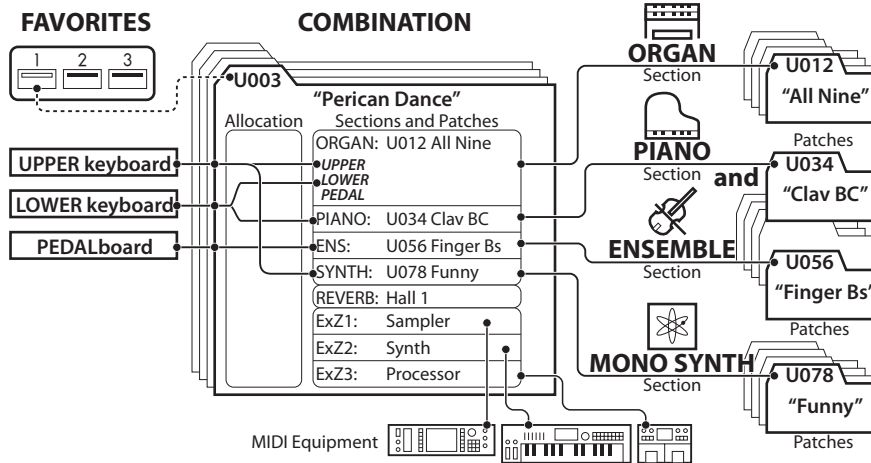

## EDITING PAGES AND PARAMETERS

### SETTING

This allows you to adjust the basic Parameters such as Patch or Volume for each Section.

### CONTROL

This allows you to select whether a Combination receives a Controller value.

### REVERB

This allows you to adjust the Parameters for the Reverb.

### INTERNAL ZONES

This allows you to adjust the Parameters for the Keyboard Channels for each Section.

### EXTERNAL ZONES

This allows you to adjust the Parameters for controlling external MIDI equipment.

## APP (APPLICATION) MENU

The APP (Application) Menu allows you to select various Menu Pages quickly. To display the APP Menu:

1. Select the COMBINATION FUNCTION Mode.
2. Press and Release the [≡] button. The Menu option shown to the right will display:
  - INITIALIZE COMBINATION** ..Initialize all the Combination Parameters in the present editing Combination.
  - REGISTER PAGE TO FAV** .....Register present displayed page to the Favorites.

To select an option:

1. Use the [▲]/[▼] buttons to highlight the option you want.
2. Press the [ENTER] button to select the desired option.

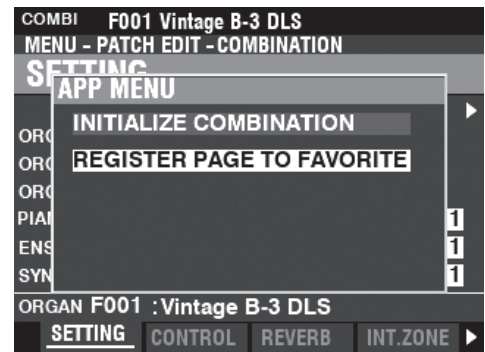
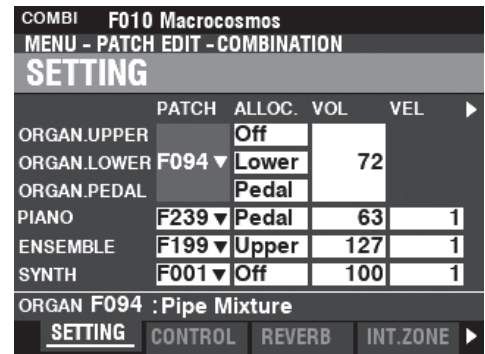

# SETTING

COMBI F010 Macrocosmos		Macrocosmos						
MENU - PATCH EDIT - COMBINATION		EDIT - COMBINATION						
SETTING								
	1 PATCH	2 ALLOC.	3 VOL	4 VEL	5 OCT	6 XPOSE	7 KEY LO	8 KEY HI
ORGAN.UPPER		Off			0	0	-2C	8G
ORGAN.LOWER	F094 ▾	Lower	72		0	0	-2C	8G
ORGAN.PEDAL		Pedal			0	0	-2C	8G
PIANO	F239 ▾	Pedal	63	1	0	0	-2C	8G
ENSEMBLE	F199 ▾	Upper	127	1	0	0	-2C	8G
SYNTH	F001 ▾	Off	100	1	0	0	-2C	8G
ORGAN F094 : Pipe Mixture				Pipe Mixture				
SETTING		CONTROL	REVERB	INT.ZONE ▶	CONTROL	REVERB	INT.ZONE ▶	

These Pages allow you to adjust the basic Parameters such as Patch or Volume for each Section.

## 1 PATCH

**Setting Range:** B001 ~ B100 (Bundle)

F001 ~ F100, U001 ~ U100 (Organ / Mono Synth)

F001 ~ F300, U001 ~ U400 (Piano / Ensemble)

This allows you to select Patch Numbers for the currently selected Combination.

## 2 ALLOC (Allocate)

**Settings:** Off, Upper, Lower, Pedal

This allows you to assign the Sections to each Keyboard.

**NOTE:** This Parameter is linked to the [ALLOCATE] buttons on the Control Panel.

## 3 VOL (Volume)

**Setting Range:** 0 ~ 127

This allows you to adjust the Volume of the selected Section.

## 4 VEL (Velocity Curve)

**Setting Range:** Off, 1 ~ 4

This allows you to select how the selected Voice Section will respond to key velocity.

“Off” is standard organ touch - the notes play at a fixed velocity (“100”) regardless of a light or heavy key pressure. “1” is the most exaggerated velocity curve while “4” is a gentler curve. “2” and “3” are curves in between.

## 5 OCT (Octave)

**Setting Range:** -2 ~ ±0 ~ +2

This allows you to select the Octave or pitch at which the selected Section will sound.

At “0” the selected Section will sound at unison or actual pitch. “-2” will sound two octaves lower and “+2” will sound two octaves higher.

**NOTE:** The actual sounding octave will be the sum of this Parameter plus the “Octave” setting in the Internal Zones (Keyboards). See page 78 for more details.

## 6 XPOSE (Transpose)

**Setting Range:** -6 ~ ±0 ~ +6

This allows you to shift the musical key of the selected Section.

**NOTE:** This Parameter can be Saved as part of a Combination (the [TRANPOSE] function controlled by the buttons on the Control Panel transposes the entire instrument and its setting is not Saved).

## 7 KEY LO (Key Range Low)

## 8 KEY HI (Key Range High)

**Setting Range:** -2C ~ 8G

These two Parameters allow you to set the Low and High note ranges for the selected Section.

### tips 3 PART ORGAN AND ALLOCATE

The Allocating method for the ORGAN Section is affected by the status of the [3 PART ORGAN]. See “3 PART ORGAN ALLOCATE” on page 137 for more information.

## CONTROL

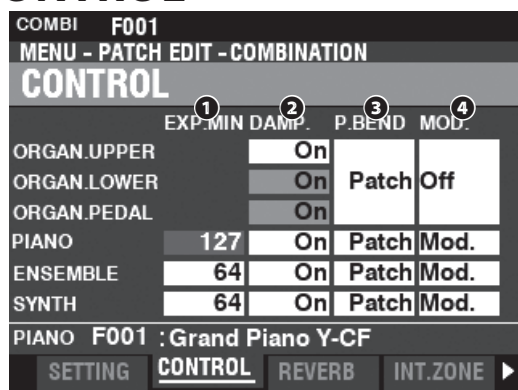

This Page allows you to select which Parameters of each Voice Section will be Recorded as part of a Combination.

### 1 EXPRESSION MINIMUM LEVEL

**Setting Range:** 0 ~ 127

This allows you to adjust the Minimum volume when the Expression Pedal is “closed” or set at its minimum position. At “0” no sound will be heard.

### 2 DAMPER

This allows you to adjust whether or not a Section will receive Damper information.

**Off** ..... A connected Damper Pedal will not affect the selected Section.

**On** ..... A connected Damper Pedal will sustain or “damp” the selected Section.

### 3 PITCH BEND

This allows you to adjust the range of the [PITCH BEND] wheel.

**Patch** ..... A separate Pitch Bend Range is set for each Voice Section.

**0 ~ 12** ..... A Pitch Bend Range setting is applied to all Voice Sections universally.

### 4 MODULATION

This allows you to select the function for the [MODULATION] wheel for each Section.

**Off** ..... No function.

**Mod** ..... (ORGAN Section excluded) Adds Modulation to the selected Section.

**Les** ..... (ORGAN Section only) Controls the speed of the Leslie.

**OD** ..... Controls the amount of Overdrive.

**MFx1** ..... Controls the amount of the **Multi Effects 1** setting.

**MFx2** ..... Controls the amount of the **Multi Effects 2** setting.

# REVERB

**SHORTCUT:** Press and Hold the [REVERB] button.

COMBI F001				
MENU - PATCH EDIT - COMBINATION				
REVERB				
SWITCH	①	Off		
DEPTH	②	86		
SECTION	ORGAN	PIANO	ENSEM	SYNTH
LEVEL	③ 100	④ 100	⑤ 100	⑥ 100
TYPE	⑦ pring	⑧ Hall2		
TIME	⑨ 112	⑩ 92		
PRE LPF	⑪ 96	⑫ 68		
◀ CONTROL REVERB INT.ZONE EXT.ZONE				

This Page allows you to select the REVERB effect for each Section.

## ① SWITCH

**Settings:** Off, On

This allows you to turn REVERB “ON” or “OFF”

**NOTE:** This Parameter is linked to the [REVERB ON] button on the Control Panel.

## ② DEPTH

**Setting Range:** 0 ~ 127

This allows you to set the overall depth of the entire Reverb effect.

**NOTE:** This Parameter is linked to the [REVERB DEPTH] knob on the Control Panel.

## ③④⑤⑥ LEVEL (ORGAN, PIANO, ENSEMBLE, SYNTH)

**Setting Range:** 0 ~ 127

This allows you to select the depth of the Reverb (= send level) for each Section.

## ⑦ TYPE (ORGAN)

## ⑧ TYPE (PIANO/ENSEMBLE/SYNTH)

This allows you to select Reverb Types. You can select different Reverb Types for the ORGAN and PIANO/ENSEMBLE/MONO SYNTH Voice Sections.

**Room 1** ..... Large room.

**Room 2** ..... Small room.

**Live** ..... Ambient room.

**Hall 1** ..... Dark Hall, similar to a theatre.

**Hall 2** ..... Bright Hall, similar to an auditorium.

**Church** ..... Church.

**Plate** ..... Iron-plate Reverb.

**Spring** ..... Spring Reverb.

## ⑨ TIME (ORGAN)

## ⑩ TIME (PIANO/ENSEMBLE/SYNTH)

**Setting Range:** 0 ~ 127

This allows you to adjust the decay of the Reverb.

A higher value results in a longer decay.

**NOTE:** You can select different Reverb Times for the ORGAN and PIANO/ENSEMBLE/MONO SYNTH Voice Sections.

## ⑪ PRE-LPF (ORGAN)

## ⑫ PRE-LPF (PIANO/ENSEMBLE/SYNTH)

**Setting Range:** 0 ~ 127

This allows you to adjust the tone quality of the Reverb.

Higher values simulate a harder floor/wall/ceiling material.

**NOTE:** You can select different settings for the ORGAN and PIANO/ENSEMBLE/MONO SYNTH Voice Sections.

**NOTE:** The Parameters described on this page are Combination Parameters and can be Recorded to individual Combinations. For a complete listing of all Combination Parameters, please consult “COMBINATION PARAMETERS” starting on page 182.

# INTERNAL ZONE

**SHORTCUT:** Press and Hold the [PEDAL TO LOWER] or [SPLIT] button.

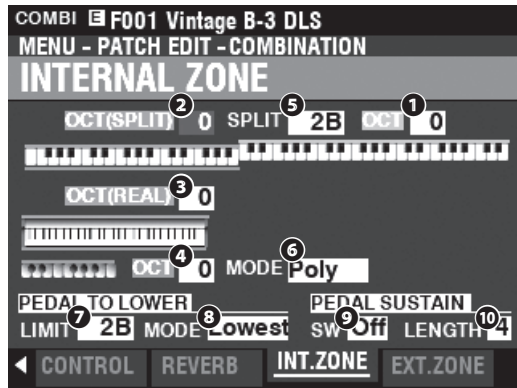

This Page allows you to adjust the Parameters for each Internal Zone.

## KEYBOARDS

- 1 OCTAVE (UPPER)
- 2 OCTAVE (LOWER SPLIT)
- 3 OCTAVE (LOWER REAL)
- 4 OCTAVE (PEDAL)

Setting Range: -2 ~ ±0 ~ +2

This allows you to select the Octave or pitch at which the selected Keyboard will sound.

**NOTE:** These Parameters are linked with the [OCTAVE] buttons on the Control Panel.

There are two LOWER Octave Parameters. OCTAVE SPLIT controls the LOWER Octave setting when the [SPLIT] button is "ON." OCTAVE REAL controls the Lower Octave setting when using an expanded keyboard as the Lower Keyboard.

- 5 SPLIT POINT

Setting Range: C-2 ~ G8

This allows you to adjust the dividing point between the LOWER Keyboard and UPPER Keyboard.

**NOTE:** The SPLIT must be active (LED "ON")

- 6 PEDAL KEY MONO/POLY

This allows you to adjust whether the Pedals play single notes ("Mono") or multiple notes ("Poly").

**Mono**..... If more than one note is played, the lowest note will sound  
**Poly**..... If more than one note is played, all notes will sound

- 7 PEDAL TO LOWER LIMIT

Setting Range: -2C ~ 8G

This allows you to adjust the highest note of the LOWER Keyboard if the [PEDAL TO LOWER] feature is "ON."

- 8 PEDAL TO LOWER MODE

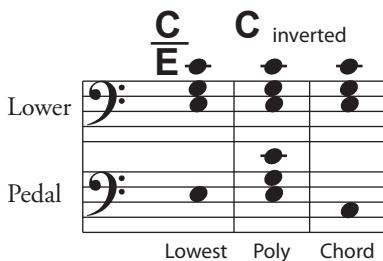

This allows you to select how the PEDAL TO LOWER responds to notes played (see the illustration above).

**Lowest**..... Sounds lowest note.  
**Poly**..... Sounds polyphonic notes.  
**Chord**..... Sounds the root of the chord.

- 9 PEDAL SUSTAIN SW

Settings: Off, On

This allows you to turn Pedal Sustain "ON" or "OFF."

- 10 PEDAL SUSTAIN LENGTH

Setting Range: 1 ~ 5

This allows you to adjust the decay length of the Pedal Sustain.

**NOTE:** For more information about Pedal Sustain, see page 55.

# EXTERNAL ZONE

**External Zones** allow you to control external MIDI equipment either from the SK PRO keyboard or expanded keyboards.

There are three External Zones in the SK PRO, each of which can be allocated to UPPER, LOWER or PEDAL Keyboards.

**NOTE:** External Zones are explained more fully starting on page 150.

**NOTE:** Using External Zones requires setting the MIDI Parameters correctly. This can be done easily using a MIDI Template provided for that purpose. See page 156 for more information about MIDI Templates.

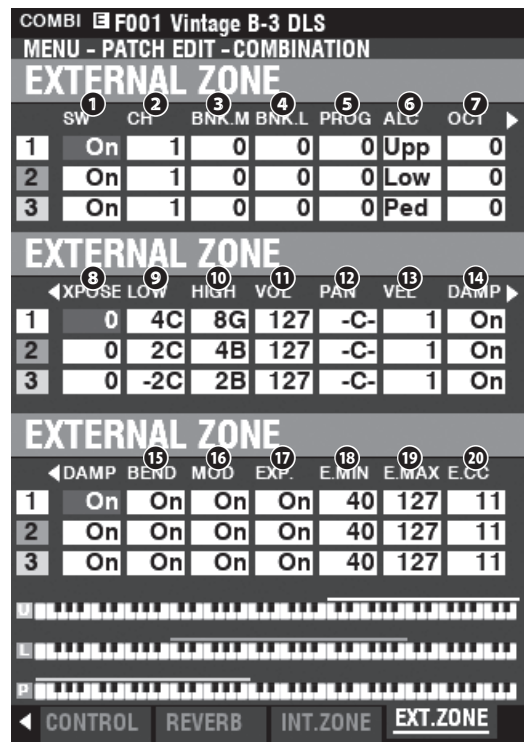

- 1 SW (Switch)

Settings: Off, On

This allows you to turn the selected Zone "ON" or "OFF."

- 2 CH (MIDI Channel)

Setting Range: 1 ~ 16

This allows you to select the MIDI Channel on which the selected Zone will transmit.

- 3 BNK.M (Bank MSB)

- 4 BNK.L (Bank LSB)

Setting Range: 0 ~ 127

- 5 PROG (Program Change)

Setting Range: 1 ~ 128

This allows you to select the Bank Select and Program Change messages transmitted by the selected Zone.

**NOTE:** For more specific information about the connected MIDI keyboard, please refer to the Owner's Manual for the specific MIDI equipment you are using.

**6 ALC (Allocate)****Setting Range:** Off, Upper, Lower, Pedal

This allows you to select which Keyboard will control the selected External Zone.

“Keyboard” refers to an actual physical keyboard (UPPER, LOWER and PEDAL), not to a SPLIT applied to the Internal Zones.

**7 OCT (Octave)****Setting Range:** -2 ~ ±0 ~ +2

This allows you to select the Octave or pitch at which the selected External Zone will sound. Adjust this Parameter if an external sound plays in an octave other than the one you need for a particular application.

**8 XPOSE (Transpose)****Setting Range:** -6 ~ ±0 ~ +6

This allows you to shift the musical key of the selected Zone.

**9 LOW (Key Range Low)****10 HIGH (Key Range High)****Setting Range:** -2C ~ 8G

This allows you to adjust the Upper and Lower note limits for the selected Zone.

**11 VOL (Volume)****Setting Range:** 0 ~ 127

This allows you to control the Volume (Controller #7) of the sound controlled by the selected Zone.

**12 PAN****Setting Range:** L64 ~ C ~ R63

This allows you to adjust the directionality or Pan setting (Controller #10) for the selected Zone.

**13 VEL (Velocity Curve)****Setting Range:** Off, 1 ~ 4

This allows you to select how the selected External Zone will respond to key velocity.

“Off” is standard organ touch - the notes play at a fixed velocity (“100”) regardless of a light or heavy key pressure. “1” is the most exaggerated velocity curve while “4” is a gentler curve. “2” and “3” are curves in between.

**14 DAMP (Damper)****Settings:** On, Off

This allows you to select whether a Damper pedal will affect the selected Zone.

**15 BEND (Pitch Bend)****Settings:** On, Off

This allows you to select whether the [PITCH BEND] wheel will affect the selected Zone.

**16 MOD (Modulation)****Settings:** On, Off

This allows you to select whether the [MODULATION] wheel will affect the selected Zone.

**17 EXP (Expression)****Settings:** On, Off

This allows you to select whether a connected Expression Pedal will affect the selected Zone.

**18 E.MIN (Expression Minimum)****Setting Range:** 0 ~ 63

This allows you to adjust the volume level when the Expression Pedal is “closed” or set at its minimum position. At “0” no sound will be heard.

**19 E.MAX (Expression Maximum)****Setting Range:** 64 ~ 127

This allows you to adjust the volume level when the Expression Pedal is all the way “open,” or set at maximum.

**20 E.CC (Expression Control Change)****Setting Range:** Off, 7, 11

This allows you to select how you want to control the level of the selected External Zone. You can select either “VOL” (Volume or Controller #7) or “EXP” (Expression or Controller #11).

**DIFFERENCE BETWEEN “VOLUME” AND “EXPRESSION”**

In purely technical terms, Volume and Expression are identical - both control loudness or sound level. The difference lies with how they are customarily used in MIDI applications, particularly in creating and playing back MIDI sequences.

The generally accepted protocol is to use Controller #7 (Volume) to set the overall or absolute level of a voice or sound, and use Controller #11 (Expression) to make variations (such as crescendi or diminuendi) against the overall level set by Controller #7. This is recommended particularly if you want to use your SK PRO as a MIDI input device to record a sequence.

**NOTE: In order for the External Zone Volume feature to work, the Expression Control Number must be set to “7:VOL.” If this Parameter is set to “11:EXP,” changing the External Zone Volume setting will have no effect.**

**MESSAGE ON/OFF**

Sometimes when transmitting MIDI messages, undesired information or not enough information may be sent. This can be prevented by switching the appropriate MIDI message “OFF.”

**MIDI messages which can be switched “OFF” by Combinations:**

.....Note, Expression, Damper (in This Page).

**System Parameters which can be switched “OFF” individually:**

.....Bank Select, Program Change, External Zone Parameters (see page 156).

**PANIC FUNCTION / PARAMETER RELOAD**

MIDI plays notes from an external instrument by sending two commands - “Note On” which starts the note playing, and “Note Off” which releases the note and stops it from playing. These two commands are always sent in pairs.

Once in a while, a Note Off command may not follow a Note On command, causing a note or notes to cipher, or sound continuously (the phenomenon popularly referred to a “stuck notes”). In this case, you need to send a MIDI command to the receiving instrument to clear the ciphering notes.

To do this, press the [DIRECTION] [▲][▼] buttons simultaneously. Doing this will send a “MIDI All Notes Off” as well as a “MIDI Reset All Controllers” command to the receiving instruments. The stuck notes will be turned off and the settings for the External Zones will be reset, then the External Zone settings will be re-sent. Normal playing can then be resumed.

# ORGAN

This FUNCTION Mode allows you to see or change Patch Parameters of the ORGAN Section.

## TO LOCATE THIS MODE:

[MENU/EXIT] - **PATCH** - **ORGAN** - [ENTER]

or press the [UPPER] and [LOWER] [DRAWBAR SELECT] buttons simultaneously.

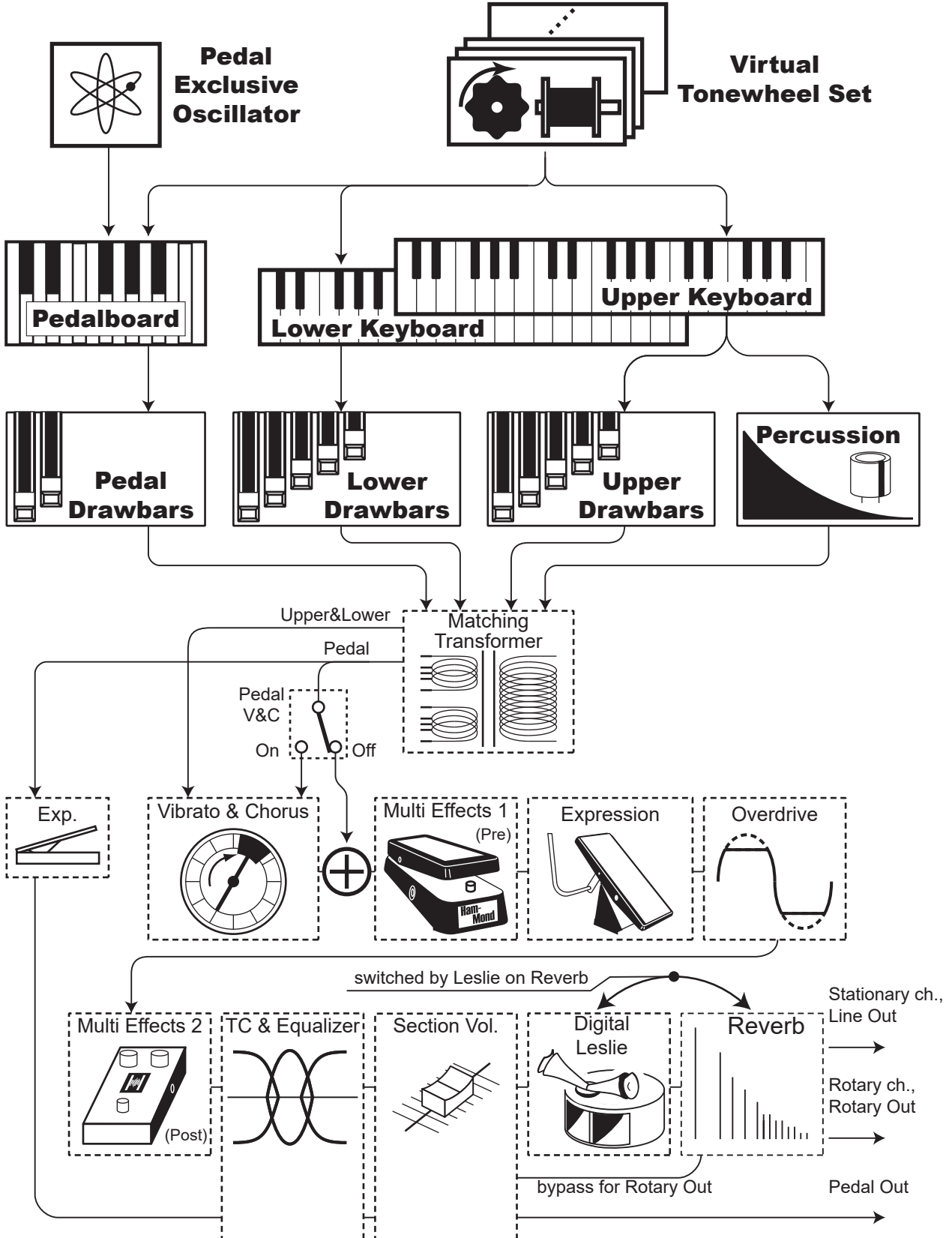



## EDITING THE ORGAN SECTION

The ORGAN Section can produce several different types of Organ tones - four Tone Wheel Organs, three Transistor Organs, and Pipe Organ. The Pipe Organ contains both Classical and Theatre pipe ranks.

You can set basic registrations using the Drawbars and make fine adjustments using the Parameters which are explained starting below.

## PAGES AND PARAMETERS

### GENERAL

This allows you to adjust the overall Parameters for each ORGAN Patch.

### DRAWBARS

This allows you to adjust the Parameters affecting the Drawbars for each Part.

### CONTACT / SUSTAIN

This allows you to adjust the Parameters affecting the Virtual Multi-Contacts and the Sustain effect for the UPPER and LOWER Parts.

### PERCUSSION

This allows you to adjust the Parameters affecting the Percussion section of the Tone Wheel Organs.

### VIBRATO&CHORUS

This allows you to adjust the Parameters affecting the Vibrato and Chorus for the Tone Wheel Organs, Vibrato for the Transistor Organs, and Tremulant for the Pipe Organ.

### MATCHING TRANSFORMER

This allows you to adjust the Parameters affecting the Matching Transformer for the Tone Wheel and Transistor Organs.

### LESLIE

This allows you to adjust the Parameters affecting the inbuilt digital Leslie for the Tone Wheel and Transistor Organs.

### MULTI EFFECT 1

This allows you to adjust the **Multi Effects 1** (Tremolo, Wah-Wah, Ring Modulator, Compressor) for the Tone Wheel and Transistor Organs.

### OVERDRIVE

This allows you to adjust the Overdrive settings for each ORGAN Patch.

### MULTI EFFECT 2

This allows you to adjust the **Multi Effects 2** (AutoPan, Phaser, Flanger, Chorus, Delay) for each ORGAN Patch.

### EQUALIZER

This allows you to adjust the Equalizer and Tone Control settings for each ORGAN Patch.

## APP (APPLICATION) MENU

The APP (Application) Menu allows you to select various Menu Pages quickly.

To display the APP Menu:

1. Select ORGAN FUNCTION Mode.
2. Press and Release the [≡] button. The following Menu options will display:  
**INITIALIZE PATCH**.....Initialize all the Patch Parameters in the present editing Patch.  
**REGISTER PAGE TO FAV**.....Register present displayed page to the Favorites.

To select an option:

1. Use the [DIRECTION] [▲]/[▼] buttons to select the option you want.
2. Press the [ENTER] button to select the desired option.

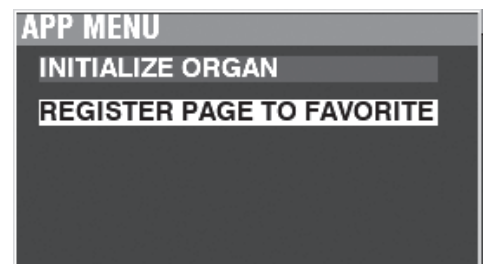
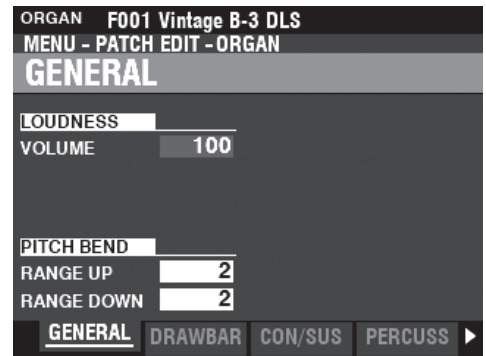

# GENERAL

SHORTCUT: Press the [UPPER] and [PEDAL] [DRAWBAR SELECT] buttons simultaneously.

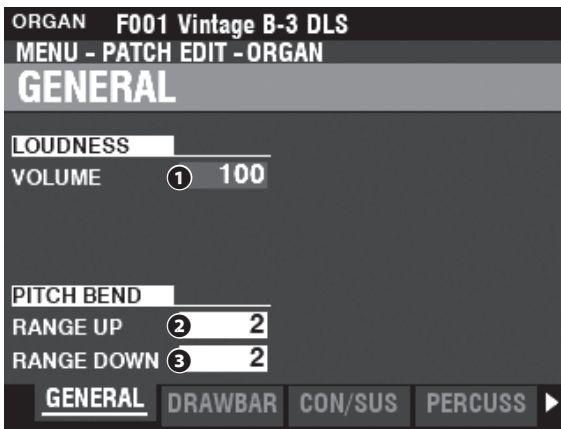

This Page allows you to adjust Parameters common to the ORGAN Patches.

## LOUDNESS

### 1 VOLUME

Setting Range: 0 - 127

This allows you to adjust the maximum volume of the selected Patch.

### tips LOUDNESS - VOLUME

The **Loudness** Parameter is independent of Expression control. The volume of the ORGAN Section can be raised or lowered independently with respect to the other Voice Sections by using this Parameter. A connected Expression Pedal will still control the volume of the entire instrument.

## PITCH BEND

### 2 RANGE UP

Setting Range: 0 - 12 [semitones]

### 3 RANGE DOWN

Setting Range: 0 - 24 [semitones]

These allow you to adjust the number of semitones the pitch of the selected ORGAN Patch will bend “Up” or “Down” using the [PITCH BEND] wheel.

### tips DISABLED PARAMETERS

All of the ORGAN Parameters affect the Tone Wheel Organs; however, some of the ORGAN Parameters do not affect the Transistor or Pipe Organs - for example, Leakage Level, Pedal Type and Custom Tone Wheels. If a particular Parameter does not affect the selected Organ Type, it will be “greyed out” or darkened in the display (see the example below). However, the value of a disabled Parameter can still be adjusted using the [VALUE] knob.

# DRAWBARS

This allows you to adjust the Drawbars Parameters for each Part.

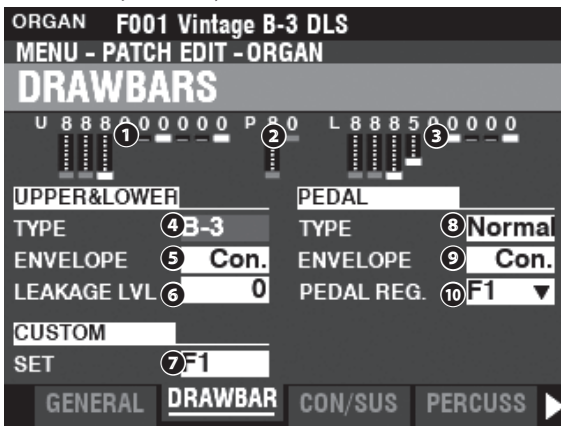

### 1 UPPER Registration

### 2 PEDAL Registration

### 3 LOWER Registration

This allows you to see the Drawbar Registrations for each Part.

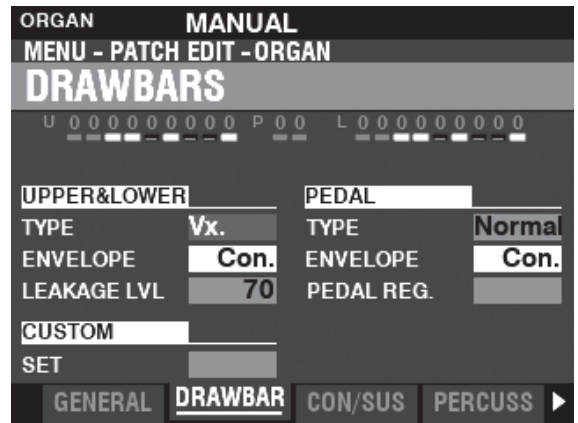

## UPPER & LOWER DRAWBARS

### 4 TYPE

This allows you to select the ORGAN Type.

**A-100** ..... Tone Wheel Organ, A-102 No. 35564.

**B-3** ..... Tone Wheel Organ, B-3 No. A27563.

**C-3** ..... Tone Wheel Organ, C-3 No. C155596.

**Mellow** ..... Pure sine waves with no harmonic development.

**Vx** ..... Reproduces the sound of a vintage British combo organ.

**Farf** ..... Reproduces the sound of a vintage Italian combo organ.

**Ace** ..... Reproduces the sound of a vintage Japanese combo organ.

**Pipe** ..... Pipe Organ.

### 5 ENVELOPE

**Settings: Con, R1 ~ R15, AR1 ~ AR15**

This allows you to adjust the rate of Attack (when a key is depressed) and Release (when the key is released).

“Con” is the envelope of the key-click(s) generated with the Virtual Multi-Contacts.

“1 -- 15” is the rate of Attack without the Virtual Multi-Contacts. The greater the value, the slower the Attack (the speed at the which the Drawbar registration sounds when a key is depressed).

The “R” Parameter changes the Release rate. The Attack rate is that provided by the Virtual Multi-Contacts. This means that the onset of the tone will be instantaneous while the Release rate is regulated by the numerical setting.

The “AR” Parameter disables the Virtual Multi-Contacts and allows you to change both the Attack and Release rate. At higher numerical settings the Attack and Release will be slow, similar to that of a pipe organ.

### 6 LEAKAGE LEVEL

**Setting Range: 0 (no Leakage tone) ~ 127 (maximum Leakage tone)**

This allows you to adjust the total volume of the leakage tone.

### 7 CUSTOM SET

**Setting Range: F1 ~ F3, U1 ~ U3**

This allows you to select a customized set for each Tone Wheel Organ and Pipe Organ.

**NOTE: See page 120 “Custom Tone Wheel” or page 126 “Custom Pipe” for more details.**

**NOTE: This Parameter is not available for the Transistor Organs.**

## PEDAL

### 8 TYPE

**Settings: Normal, Muted**

This allows you to select the ORGAN Type for the PEDAL Part.

**Normal** ..... Traditional tone-wheel registration of the B-3/C-3/A-100.

**Muted** ..... Analog pedal tones as on the classic X-5.

**NOTE: When one of the Transistor Organs (Vx, Farf, or Ace.) is selected for the UPPER & LOWER, Muted is automatically selected for the PEDAL Part.**

**NOTE: When the Pipe Organ Type is selected for the UPPER & LOWER Parts, Pipe is automatically selected for the PEDAL Part and the other PEDAL Parameters are unavailable.**

### 9 ENVELOPE

**Setting Range: Con, R1 ~ R15, AR1 ~ AR15**

This allows you to set the Attack and Release characteristics of the PEDAL tones.

**NOTE: See paragraph 5 on this page for more information.**

**NOTE: This Parameter is available on Tone Wheel Organs A-100, B-3, C-3 and Mellow.**

### 10 SUB DRAWBARS

**Setting Range: F1 ~ F3, U1 ~ U3**

This allows you to select the harmonic settings for the PEDAL or Sub Drawbars when the “Normal” Type is selected.

**NOTE: This Parameter is available on Tone Wheel Organs “A-100,” “B-3,” “C-3” and “Mellow.”**

### tips ENVELOPE

The variation of a sound over time, as is used in sound synthesis.

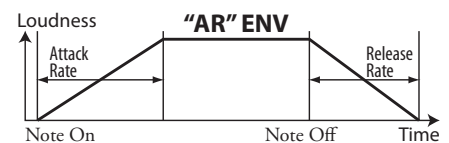
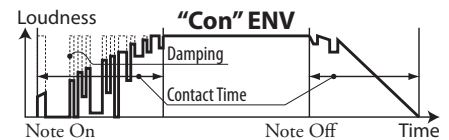

### tips KEY CLICK

On tone-wheel organs such as the B-3/C-3/A-100, each time a key is depressed 9 electrical switch contacts are closed by means of 9 horizontal flat springs which touch 9 busbars. Each time a contact is closed or released, a “key click” was produced. This characteristic is replicated on the SK PRO.

### tips EXAMPLES OF KEY-CLICK SETTINGS

Simulation of a classic multi-contact Hammond Organ such as B-3/C-3/A-100:

**ENV=CON**

Simulation of a PCM synthesizer to produce the “key click” only at the attack:

**ENV=R1**

Slow envelope similar to that of a pipe organ:

**ENV=AR15**

## CONTACT / SUSTAIN

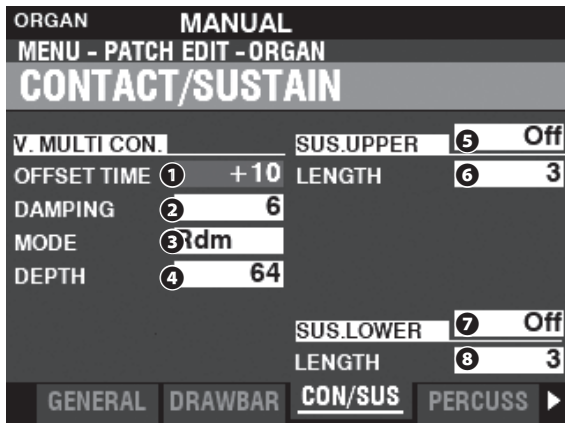

This Page allows you to adjust the Parameters which affect the Virtual Multi-Contacts and the Sustain effect for the UPPER and LOWER Parts.

### VIRTUAL MULTI-CONTACT

#### 1 OFFSET TIME

**Setting Range:** -64 ~ ±0 ~ +63

This allows you to set the time when a note is “ON” until complete contact is made. A higher value causes a longer Attack time and a shorter Release time.

#### 2 DAMPING

**Setting Range:** 0 ~ 31

This allows you to control the damping rate of the Virtual Multi-Contacts.

The higher the value, the more pronounced the Key Click.

#### 3 MODE

This allows you to select how the Virtual Multi-Contacts (“VMC’s”) will sound when keys are depressed.

**Random**.....When a key is depressed, each contact of the VMC’s will connect in a random order at the shallow point, and all the contacts are fully made when the key reaches its deep point.

**Velocity**.....When a key is depressed to its deep point, each contact of the VMC’s is made by a time difference depending on the velocity.

#### 4 DEPTH

**Setting Range:** 0 ~ 127

This allows you to adjust the amount of time for each VMC to sound when a key is depressed.

At “0” all the VMC’s sound simultaneously. The higher the value, the longer the time interval between contacts.

### UPPER & LOWER SUSTAIN

This allows you to add a smooth decay to the UPPER & LOWER Drawbars tones.

#### 56 SWITCH

**Settings:** Off, On

This allows you to turn Sustain “ON” or “OFF” on the selected Part.

#### 78 LENGTH

**Setting Range:** 1 ~ 5

This allows you to adjust the length of the Sustain effect for the selected Part.

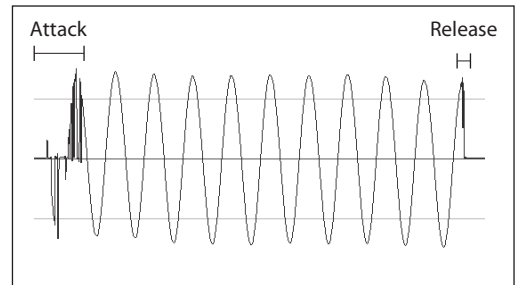

#### tips WHAT ARE CONTACTS?

When a key is depressed on a tone-wheel Hammond Organ, it closes 9 small electrical switch contacts. These 9 contacts represent the 9 pitches provided by the Drawbars. The contacts are closed and opened by means of 9 horizontal flat springs which touch 9 busbars. When a flat spring touches a busbar, electrical contact is made and the harmonic is permitted to sound. Since the 9 busbars are physically separated, the harmonics do not all sound simultaneously, but in succession. This can be heard most clearly by selecting one of the four Manual Drawbar sets of a tone-wheel organ, pulling all of the Drawbars out to their maximum volume setting and slowly pressing a playing key. Each of the harmonics will add in a sequence from highest to lowest until all 9 frequencies will be heard when the key is at the bottom of its travel. The “Key-Click” on tone-wheel Hammond Organs is due to these physical characteristics. Also, if a key is released quickly it will bounce at the time of contact, creating an effect known as “Key Bounce” or “Chattering”.

#### tips WHY LESS RELEASE KEY CLICK?

One of the characteristics of the key contacts on a tone-wheel organ is, the Release “click” is somewhat softer and less intense than the Attack “click.” This characteristic is replicated on the SK PRO.

#### tips SUSTAIN

The word “Sustain” has a different meaning for an electronic organ than for a synthesizer. On an electronic organ, “Sustain” refers to a note or notes continuing to sound and smoothly decaying after the key is released. This is called “Release” on a synthesizer.

#### tips WHERE IS THE PEDAL SUSTAIN?

The Pedal Sustain is controlled from the INTERNAL ZONE FUNCTION Mode in the COMBINATION Edit Mode due to the fact that Pedal Sustain affects any Voice Section allocated to the PEDAL Part and not only the ORGAN Voice Section. See page 78 for more details.

# PERCUSSION

**SHORTCUT:** Press and Hold any of the four [UPPER PERCUSSION] buttons.

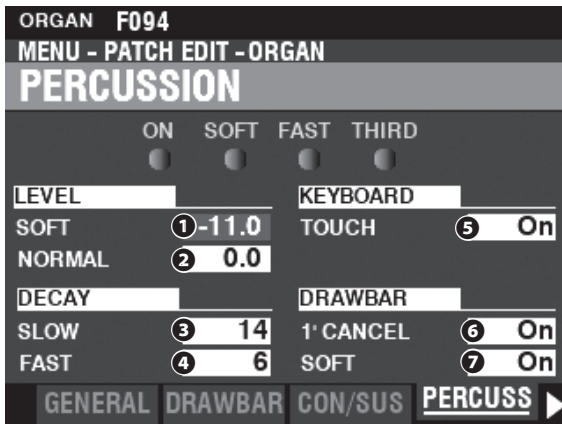

This Page allows you to make changes to the Percussion tones.

## LEVEL

### ① SOFT

### ② NORMAL

**Setting Range:** -22.0 ~ +10.5 dB

This allows you to adjust the Percussion Volume levels.

**NORMAL**.....Level when the [SOFT] button is "OFF"

**SOFT**.....Level when the [SOFT] button is "ON"

## DECAY

### ③ SLOW

### ④ FAST

**Setting Range:** 1 ~ 24, Cont

This allows you to adjust the Percussion Decay time.

A higher value will result in a slower Decay.

**SLOW**.....Decay rate when the [FAST] button is "OFF"

**FAST**.....Decay rate when the [FAST] button is "ON"

**C (continuous)**.....No decay, The Percussion tone is sustained while keys are depressed.

## KEYBOARD

### ⑤ TOUCH

**Settings:** Off, On

This allows you to set the Touch Response of the Percussion.

**Off**.....Percussion will sound only if you play the keys in a detached manner (non-legato). Any degree of detachment is sufficient.

**On**.....Each key will sound when played regardless of whether other keys are being held.

## DRAWBARS

### ⑥ 1' CANCEL

**Settings:** On, Off

This allows you to cancel the Upper 1' Drawbar while using Percussion.

**On**.....The 1' Drawbar will be canceled when Percussion is "ON"

**Off**.....The 1' Drawbar will continue to sound when Percussion is "ON"

### ⑦ DRAWBAR - SOFT

**Settings:** On, Off

This allows you to reduce the Upper Drawbar volume while using the Percussion if the [SOFT] button is "OFF" (LED not lit).

**On**.....The volume level of the Drawbars will be reduced by a small amount when Percussion is "ON" at Normal volume.

**Off**.....The volume of the Drawbars will remain at the same level when Percussion is "ON" at Normal volume.

### tips TOUCH

The percussion generator on the B-3/C-3 had a single envelope, which would not recycle until all keys were raised. Originally thought to be a defect, the resulting response became a desired trait.

### tips 1' CANCEL

The B-3/C-3 had no exclusive key contact for the Percussion, but, used the 1' contact. The SK PRO replicates this feature.

### tips SOFT

On a vintage B-3/C-3, when Percussion was turned "ON" and the Volume setting was "NORMAL," the Upper Manual Drawbars were slightly reduced in volume. The SK PRO replicates this feature.

## VIBRATO & CHORUS

**SHORTCUT:** Press and Hold the VIBRATO and CHORUS [MODE], [UPPER] or [LOWER] buttons.

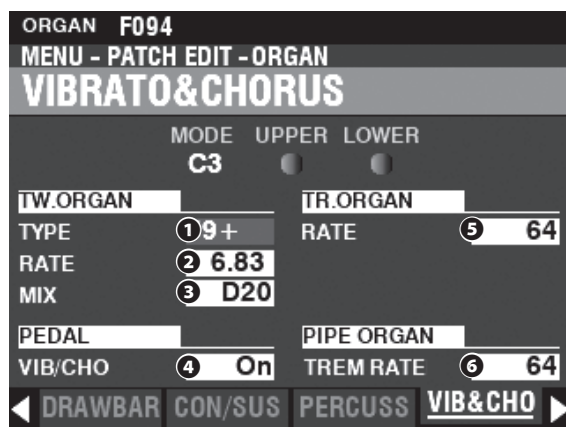

This Page allows you to adjust the Vibrato & Chorus of the Tone Wheel Organs, Vibrato for the Transistor Organs, and Tremulant for the Pipe Organ.

### TONE WHEEL ORGAN

#### 1 TYPE

**Settings: See below**

This allows you to select the Vibrato Delay Line type.

'55-57 .....Metal Box (1955 - 1957).

'57-59 .....Big Silver Box (1957 - 1959).

'59+ .....Small Silver Box (1959 or later).

#### 2 RATE

**Setting Range: 5.78 ~ 7.90 Hz (349 ~ 475 rpm)**

This allows you to adjust the rate of the Vibrato & Chorus.

#### 3 MIX

**Setting Range: D64 ~ Even ~ 63V**

This allows you to adjust the intensity of the Chorus (C1 to C3).

"D" = direct or dry sound. "V" = Vibrato sound.

### PEDAL

#### 4 PEDAL

**Settings: Off, On**

This allows you to select whether the Vibrato & Chorus affects the PEDAL Part when the Vibrato & Chorus [LOWER] button is "ON."

### TRANSISTOR ORGAN

#### 5 RATE

**Setting Range: 0 ~ 127**

This allows you to adjust the rate of the Vibrato.

### PIPE ORGAN

#### 6 TREMULANT RATE

**Setting Range: 0 ~ 127**

This allows you to adjust the rate of the Tremulant.

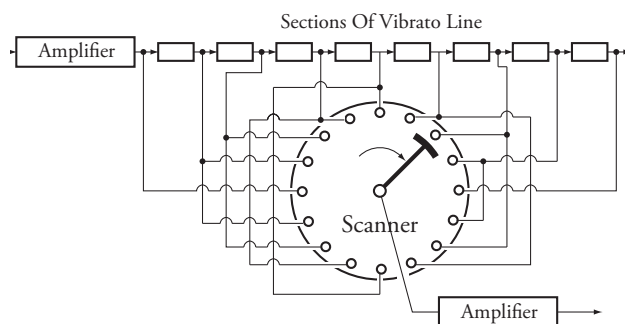

#### tips VIBRATO & CHORUS

The illustration above shows the vibrato equipment of a tone-wheel Hammond Organ such as a B-3/C-3/A-100.

On a tone-wheel Hammond Organ equipped with Vibrato & Chorus, the vibrato circuitry consists of a series of plural coils or low-pass filter sections called a "delay line" or "line box" and a motor-driven "scanner" which scans the delay line and progressively retards the phase, creating the Vibrato effect.

#### tips VIBRATO TYPE

Hammond tone-wheel organs with Vibrato & Chorus were manufactured from 1949 through 1975. During that time, several different types of vibrato circuits were employed, particularly line boxes of different constructions. The Vibrato TYPE feature replicates the effect of different types of Vibrato delay lines.

#### tips MIX

"Vibrato Chorus," is obtained when the vibrato output signal is mixed with a portion of signal without vibrato. This creates a "shimmering" effect much used by jazz, blues and rock organists. This Parameter allows you to adjust the balance between the Vibrato and non-Vibrato signals to create the type of Chorus effect you want.

#### tips PEDAL

On the B-3/C-3/A-100, the Vibrato and Chorus affects the Pedal tones in addition to the Lower Manual Drawbar tones. Also, starting with the B-2/C-2, vintage Hammonds had **Selective Vibrato**, meaning that Vibrato could be had on Upper and Lower Manuals/Pedal independently (on previous models the Vibrato and Chorus affected the entire organ). These are replicated on the SK PRO.

#### tips VIBRATO (TRANSISTOR ORGAN)

On an electronic organ, Vibrato is accomplished by modulating the frequency of the master oscillator(s). This effect is replicated on the SK PRO.

#### tips TREMULANT

On a pipe organ, a **Tremulant** varies the air pressure the air pressure to the pipes periodically, producing a vibrato or tremolo effect. On the SK PRO, Tremulant can be applied to the Pipe Voices.

## MATCHING TRANSFORMER

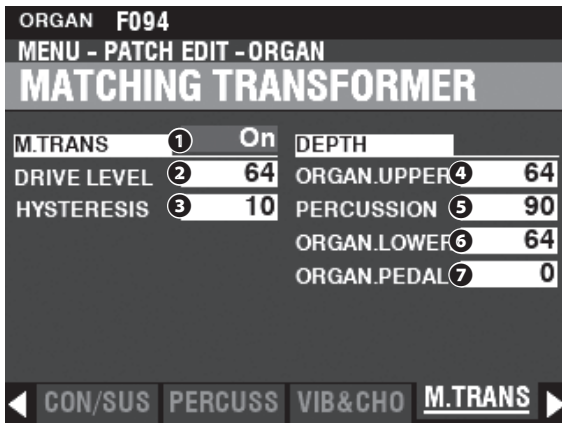

This Page allows you to adjust the Parameters affecting the Matching Transformer for the Tone Wheel and Transistor Organs.

### MATCHING TRANSFORMER

#### 1 SWITCH

Settings: Off, On

This allows you to turn the Matching Transformer effect “ON” or “OFF.”

#### 2 DRIVE

Setting Range: 0 ~ 127

This allows you to set the saturation level of the Matching Transformer. A higher value will result in more saturation at low volume levels.

#### 3 HYSTERESIS

Setting Range: 0 ~ 127

This allows you to set the strength of the hysteresis characteristics. The higher the value, the more “asymmetrical” the sound.

### DEPTH

#### 4 UPPER DRAWBARS

#### 5 PERCUSSION

#### 6 LOWER DRAWBARS

#### 7 PEDAL DRAWBARS

Setting Range: 0 ~ 127

This allows you to set the amount of the Matching Transformer modeling for each Part and for the Percussion.

The higher the value, the deeper the effect.

#### tips

#### WHAT IS A “MATCHING TRANSFORMER?”

The purpose of the Matching Transformer in a Hammond tone-wheel organ is to “match” the low Impedance of the generator and key circuits to the high impedance amplifier input.

It combines the individual tones from each Drawbar into one complex musical tone.

Doing this imparts some unique characteristics to the sound (see the illustrations below), which are part of the tonal characteristics of a Hammond tone-wheel organ such as the B-3.

Even though transistor organs do not have a Matching Transformer, these Parameters can also be used for the Transistor Organs.

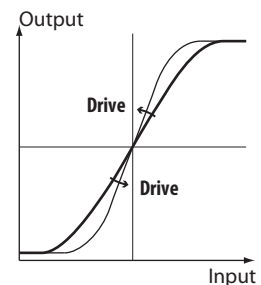

How the Trans - Drive works

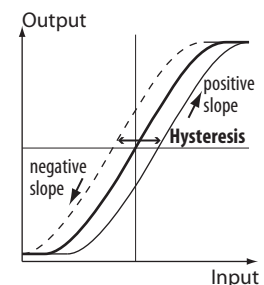

How the Trans - Hysteresis works

## LESLIE

**SHORTCUT:** Press and Hold the LESLIE [BYPASS], [STOP] or [FAST] buttons.

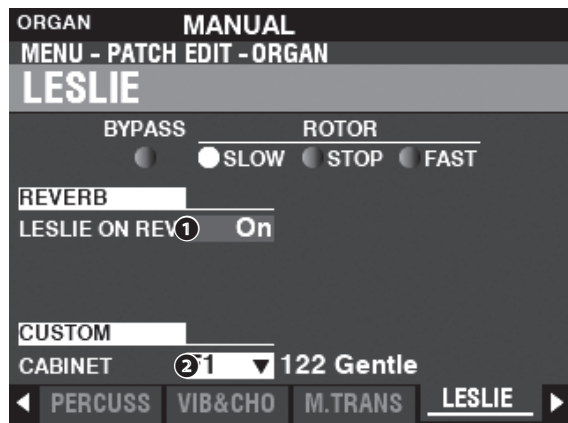

This Page allows you to adjust the Parameters affecting the inbuilt digital Leslie for the Tone Wheel and Transistor Organs.

## REVERB

### 1 LESLIE ON REVERB

**Settings:** Off, On

This allows you to adjust the routing of the Reverb.

**Off** ..... The digital Leslie modulates the ORGAN sounds only.

**On** ..... The digital Leslie modulates both the ORGAN sounds and the Reverb.

**NOTE:** This Parameter does NOT affect a connected Leslie Speaker Cabinet.

## CABINET

### 2 CUSTOM CABINET

**Setting Range:** F1 ~ F8, U1 ~ U8

This allows you to select a Custom Leslie Cabinet.

**NOTE:** See page 124 for more information about Custom Leslie Cabinets

### tips LESLIE ON REVERB

When an audio signal containing Reverb is sent to a Leslie Cabinet, the Reverb is modulated along with the main signal. This characteristic can be replicated using this Parameter.

When this Parameter is "OFF," the effect is that of a Leslie Cabinet speaking into an auditorium or a large live room, or a Leslie Cabinet having a separate Reverb amplifier and speakers such as a vintage 122RV - the Organ tones are affected by the Leslie rotors but not the Reverb.

When this Parameter is "ON," the effect is that of an audio signal containing both Organ tones and Reverb being fed into a single-channel Leslie - the rotors will modulate the Reverb as well as the basic Organ tones.



# MULTI EFFECT 1

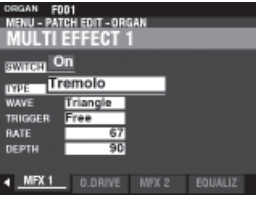

See “Multi Effects 1” (P. 106).

# OVERDRIVE



See “Overdrive.” (P. 111)

# MULTI EFFECT 2

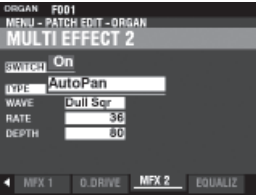

See “Multi Effects 2.” (P. 112)

# EQUALIZER

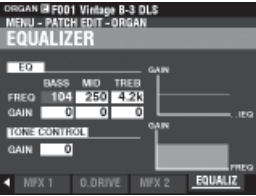

See “Equalizer.” (P. 116)

# PIANO/ENSEMBLE

These FUNCTION Modes allow you to edit the PIANO and ENSEMBLE Patches.

## TO LOCATE THIS MODE:

[MENU/EXIT] - PATCH - PIANO/ENSEMBLE - [ENTER]

or press the [EDIT] button in each Section.

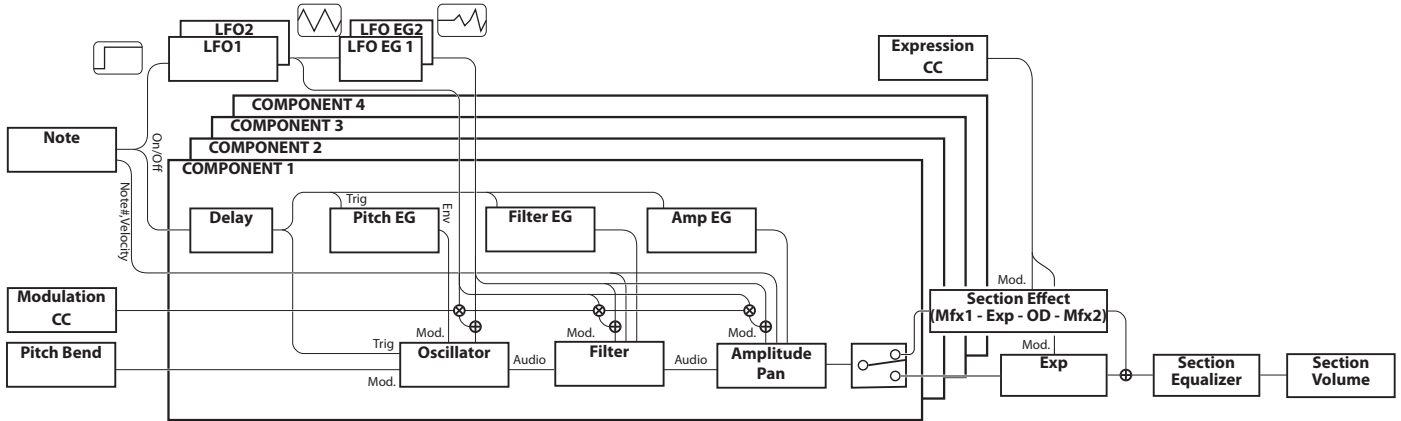

## EDITING THE PIANO/ENSEMBLE SECTIONS

Both the PIANO and ENSEMBLE Sections contain 4 sounding units called **Components**.

The waveform generated by the oscillator in each Component can be modified by the Filter (timber), Amplitude (volume), Section Effects (Multi Effects and Overdrive) and the Equalizer.

Timed characteristics such as LFO and Envelope Generators for Pitch, Filter and Amplitude are also provided.

## PAGES AND CONTENTS

### GENERAL

This allows you to adjust the common Parameters in a PIANO or ENSEMBLE Patch.

#### 1. VOLUME

This allows you to adjust the volume.

#### 2. PORTAMENTO

This allows you to slide the pitch between last and current notes smoothly.

#### 3. MONO/POLY

This allows you to adjust the monophonic or polyphonic, and sounding priority.

#### 4. PITCH BEND

This allows you to adjust the length of the Pitch Bend.

### ProChord™

This allows you to play complex harmonic patterns which regarding played chord by the four Components as the players.

### LFO

This allows you to adjust the LFO - Low Frequency Oscillators which makes vibrato or tremolo effect, and their depth.

### COMPONENT

This allows you to adjust the Parameters with regarding each Component.

#### 1. BASIC

This allows you to adjust the basic Parameters such as sounding, volume, “ON” or “OFF” the Section Effects, sounding note range, and sounding velocity range.

#### 2. OSCILLATOR

This allows you to adjust the Waveform and the pitch.

#### 3. PITCH EG

This allows you to adjust the Pitch Envelope.

#### 4. DELAY

This allows you to adjust the Delay for sounding “ON” or “OFF” by playing or other Component.

#### 5. FILTER

This allows you to adjust the Filter.

#### 6. FILTER EG

This allows you to adjust the Filter Envelope.

#### 7. AMPLITUDE

This allows you to adjust the Amplitude and the Panning.

#### 8. AMPLITUDE EG

This allows you to set the Amplitude Envelope.

### MULTI EFFECT 1

This allows you to adjust the **Multi Effects 1** (Tremolo, Wah-Wah, Ring Modulator, Compressor) for each PIANO/ENSEMBLE Patch.

### OVERDRIVE

This allows you to adjust the Overdrive effect in this Section.

### MULTI EFFECT 2

This allows you to adjust the **Multi Effects 2** (AutoPan, Phaser, Flanger, Chorus, Delay) for each PIANO/ENSEMBLE Patch.

### EQUALIZER

This allows you to adjust the Equalizer in this Section.

## APP (APPLICATION) MENU

The APP (Application) Menu allows you to select various Menu Pages quickly. To display the APP Menu:

1. Select the PIANO or ENSEMBLE FUNCTION Mode.
2. Press and Release the [=] button. The Menu options shown below will display:

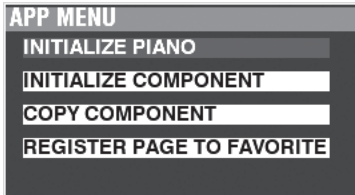

- INITIALIZE PIANO/ENS**.....Initializes the Patch Parameters in the currently selected Patch.
- INITIALIZE COMPONENT** .....Initializes the Component Parameters in the currently selected Patch.
- COPY COMPONENT** .....Copies the Parameters in one Component to another Component.
- REGISTER PAGE TO FAV** .....Registers the currently selected Page to the Favorites.

To select an option:

1. Use the [DIRECTION] [▲]/[▼] buttons to select the option you want.
2. Press the [ENTER] button to select the desired option.

## GENERAL

**SHORTCUT:** Press the [EDIT] button in the PIANO or ENSEMBLE Voice Section.

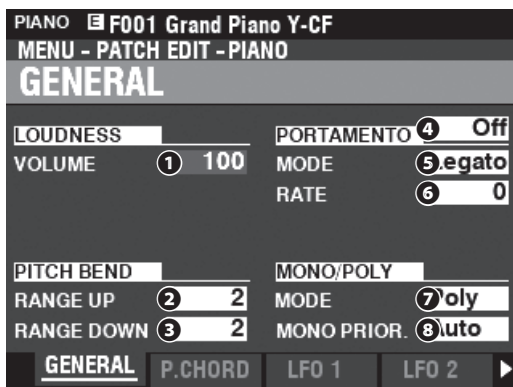

## LOUDNESS

### 1 VOLUME

Setting Range: 0 ~ 127

This allows you to adjust the overall volume of the selected Patch.

**NOTE:** The "Loudness" Parameter is independent of Expression control. The volume of the PIANO or ENSEMBLE Section can be raised or lowered independently with respect to the other Voice Sections by using this Parameter. A connected Expression Pedal will still control the volume of the entire instrument.

## PITCH BEND

### 2 RANGE UP

Setting Range: 0 - 12 [semitones]

### 3 RANGE DOWN

Setting Range: 0 - 24 [semitones]

These allow you to adjust the number of semitones the pitch of the selected Patch will bend "Up" or "Down" using the [PITCH BEND] wheel.

## PORTAMENTO

### 4 SWITCH

Settings: Off, On

This allows you to turn the Portamento effect "ON" or "OFF"

### 5 MODE

This allows you to adjust how to control the Portamento effect from the keyboard

**Every** ..... The Portamento will be heard with every keypress.

**Legato** ..... The Portamento will be heard only when keys are played 'legato' (a key is depressed while another key is held).

### 6 RATE

Setting Range: 0 ~ 127

This allows you to adjust the rate at which the pitch changes using Portamento. The higher the value, the more slowly the pitch rises or falls.

## MONO/POLY

### 7 MONO/POLY

This allows you to adjust whether the selected Patch will play single notes ("Mono") or multiple notes ("Poly").

**Poly** ..... If more than one note is played, all notes will sound.

**Mono** ..... If more than one note is played, only one note will sound.

**M/P** ..... More than one note can be played; however, the last note released will be erased by the next note played.

### 8 MONO PRIORITY

This allows you to adjust which note will sound on the selected Patch if more than one note is played in MONO Mode.

**Auto** ..... The highest note played will sound when this Section is used with other Sections. The last played note will sound when this Section is used alone.

**Last** ..... The last played note will sound.

**Lowest** ..... The lowest note played will sound.

**Highest** ..... The highest note played will sound.

## ProChord™

1. Play LOWER as Chord

2. Play UPPER as Melody

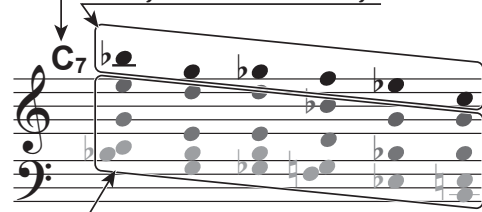

3. The Harmony sounds together.

This allows you to reproduce complex harmonies by playing a single-note melody with the right hand and chords with the left hand. The four Components provide both the Melody and

Harmony notes in different configurations depending on the specific ProChord Type or harmony pattern selected.

**NOTE: The ProChord feature works on the UPPER Keyboard only.**

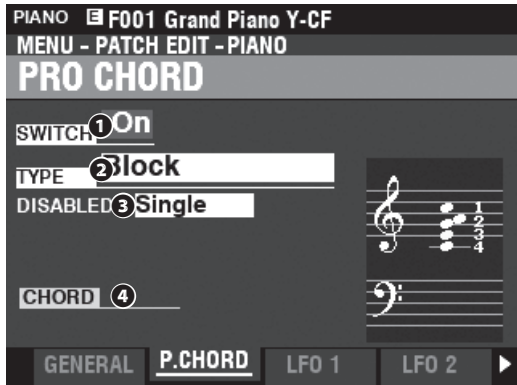

**1 SWITCH**

**Settings: Off, On**

This allows you to turn ProChord “ON” or “OFF”

**2 MODE**

**Settings: Closed, Open, Duet, Block, Big Band Sax, Big Band, Small Combo, Theatre, Hymn, Quartet 1, Quartet 2, Jazz Brass, Strings, Harmonic Chime, Old Time, 4 Part Closed, 5 Part Open**

This allows you to select the ProChord Type or harmony pattern.

**3 DISABLED**

**Settings: Single, Unison**

This allows you to select how ProChord works when it is disabled (no chord outlined by the left hand or disabled by the Foot Switch).

**Single**..... Sounds Component 1.  
**Unison**..... Sounds all selected Components.

**LFO**

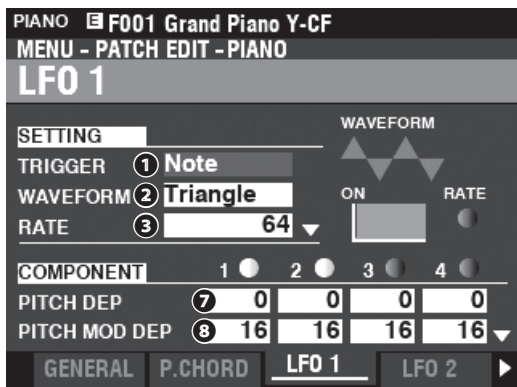

Both the PIANO and ENSEMBLE Voices Sections have two LFOs (Low Frequency Oscillators). These can be used to modulate various Components or Parameters.

**1 TRIGGER MODE**

**Settings: Note, Free**

This allows you to adjust whether the phase of the LFO will reset each time a key is depressed.

**Note**..... The LFO of each note oscillates individually. Each LFO will start its cycle when a key is depressed.

**Free**..... Pressing a key will intercept the LFO at whatever point it happens to be in its cycle.

**2 WAVEFORM**

**Settings: See below**

This allows you to select the waveform of the LFO.

- Triangle** ..... Triangle wave.
- Square** ..... Square wave Positive and Negative.
- Rectangle** ..... Square wave Positive and Zero.
- Saw Up** ..... Sawtooth Upward wave.
- Saw Down** ..... Sawtooth Downward wave.
- S/H** ..... Sample and Hold.
- Fluctuation** ... Random.

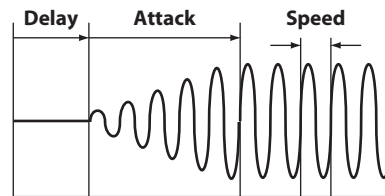

On

**3 RATE**

**Setting Range: 0 ~ 127**

This allows you to adjust the Oscillation Rate of the LFO.

**4 DELAY TIME**

**Setting Range: 0 ~ 127**

This allows you to adjust the amount of time after the initial keypress before the LFO begins oscillating.

**5 ATTACK RATE**

**Setting Range: 0 ~ 127**

This allows you to adjust the amount of time for the LFO to build to its full amount when using Delay Time.

**6 ATTACK KEY TRACK**

**Setting Range: -64 ~ 0 ~ +63**

This allows you to adjust how the Attack Rate is modulated by the note or pitch.

**7 PITCH DEPTH**

**8 PITCH MOD DEPTH**

**9 FILTER DEPTH**

**10 FILTER MOD DEPTH**

**11 AMPLITUDE DEPTH**

**12 AMPLITUDE MOD DEPTH**

These Parameters allow you to adjust the LFO depth for each Component. “MOD DEPTH ” sets the maximum LFO depth using the [MODULATION] wheel.

# COMPONENT

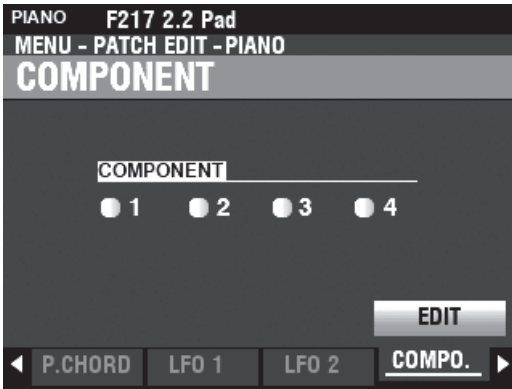

To edit a Component, select the **COMPONENT - EDIT** icon and press the [ENTER] button.

## COMPONENT - BASIC

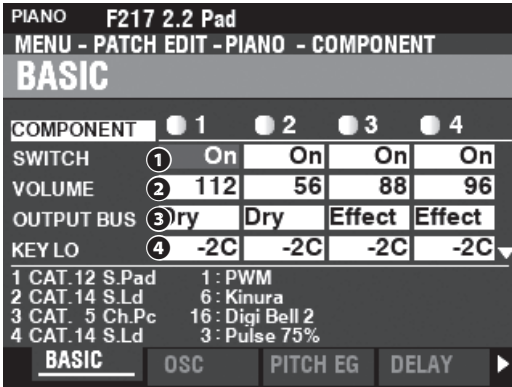

### 1 SWITCH

Settings: Off, On

This allows you to turn the selected Component “ON” or “OFF.”

Off .....No Sound.

On.....Sound.

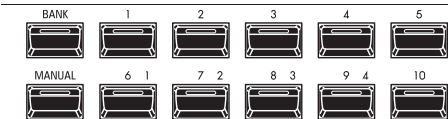

Use the [[1] [2] [3] and [4] [NUMBER] buttons to turn each individual Component “ON” or “OFF” while editing.

### 2 VOLUME

Setting Range: 0 ~ 127

This allows you to adjust the Volume of the selected Component.

### 3 OUTPUT BUS

Settings: Dry, Effect

This allows you to select whether Section Effects are enabled or disabled for this Component.

Dry .....Disabled

Effect.....Enabled

### 4 5 KEY RANGE LOW, HIGH

Setting Range: -2C ~ 8G

This allows you to adjust the sounding range of the selected Component by note number.

### 6 7 VELOCITY RANGE LOW, HIGH

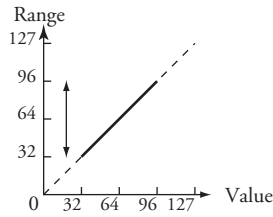

Setting Range: 1 ~ 127

This allows you to adjust the sounding range of the selected Component.

### 8 VELOCITY OFFSET

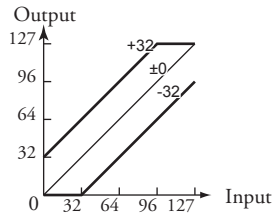

Setting Range: -64 ~ ±0 ~ +63

This allows you to adjust the relative loudness of notes played using the selected Component.

### 9 VELOCITY DEPTH

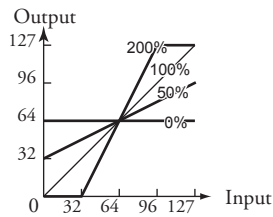

Setting Range: 0 ~ 200 [%]

This allows you to adjust the response of the selected Component to key velocity.

At “0” there is no change in velocity. At “127,” the volume is changed by the maximum amount in proportion to the velocity.

#### tips WHAT IS A “COMPONENT?”

There are 300 pre-programmed Patches for the PIANO and ENSEMBLE Voices Sections. Several of these contain multiple waveforms, such as “Nylon&Steel Gtrs” and “Section Str. Oct.” This is possible because each individual Patch can contain up to four (4) sounding Components. Each Component can contain a Waveform and can be edited separately, though it is not necessary for each Component to be active as part of a Patch. The Component Parameters are explained starting on this page.

## COMPONENT - OSCILLATOR

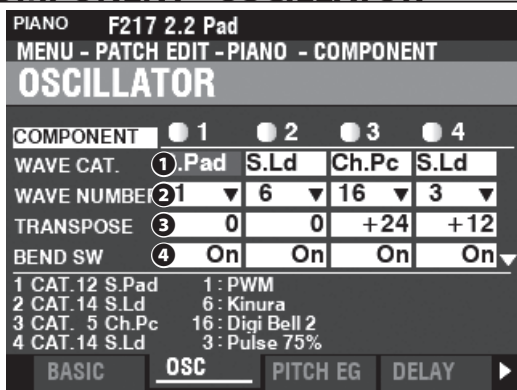

### 1 WAVEFORM CATEGORY

This allows you to select the Waveform Category.

- 1 ..... A. Piano
- 2 ..... E. Piano
- 3 ..... Harpsichord
- 4 ..... Clav.
- 5 ..... Chromatic Percussion
- 6 ..... Guitar
- 7 ..... Ethnic
- 8 ..... SFX
- 9 ..... Wind
- 10 ..... Strings
- 11 ..... Choir
- 12 ..... Synth Pad
- 13 ..... Bass
- 14 ..... Synth Lead
- 15 ..... Free Reed
- 16 ..... Percussion

### 2 WAVEFORM NUMBER

This allows you to select a specific Waveform Number.

**NOTE:** See page 176 for a list of Waveform Numbers.

### 3 TRANSPOSE

**Setting Range:** -63 ~ ±0 ~ +63 [semitones]

This allows you to adjust the sounding pitch of the selected Component by half-steps or semitones.

### 4 PITCH BEND SWITCH

**Settings:** Off, On

This allows you to select whether the selected Component will receive Pitch Bend.

**Off** ..... Does not receive.

**On** ..... Receives.

### 5 PITCH KEY TRACK

**Setting Range:** -100 ~ ±0 ~ +100 [%]

This allows you to adjust the amount of pitch change between keys on the keyboard for the selected Component.

At “+100” the musical distance between any two adjacent notes will be 100 cents or one half-step. This is the normal setting. At “+50,” the notes will be one quarter-step apart.

At “0” every note on the keyboard will sound the same pitch.

### 6 FINE TUNE

**Setting Range:** -100 ~ ±0 ~ +100 [cents]

This allows you to adjust the sounding pitch of the selected Component by cents.

At “-100” the pitch will be one half-step flat. At “+100” the pitch will be one half-step sharp.

### 7 STRETCH TUNE DEPTH

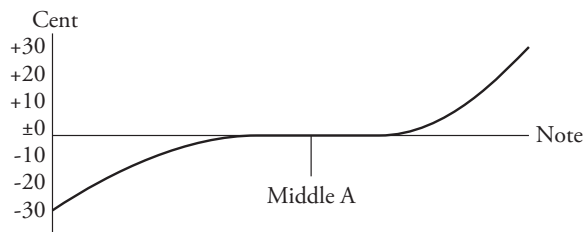

**Setting Range:** 0 ~ 127

This allows you to adjust the depth of the Stretch Tuning for the selected Component.

“0” is an Equal Temperament. If the value is increased, the bass will sound lower and the treble will sound higher.

**NOTE:** “Stretch tuning” is a method of tuning stringed instruments (notably piano) to compensate for their inherent inharmonicity. This characteristic can differ from instrument to instrument.

### 8 PITCH EG DEPTH

**Setting Range:** -64 ~ ±0 ~ +63

This allows you to adjust the depth of the pitch changing of the Pitch EG (Envelope Generator for the selected Component).

At “0” there is no pitch change. At “-64” or “+63,” the pitch will change down or up by one octave.

**NOTE:** A large amount of pitch change may produce artifacts such as “step noise.”

### 9 PITCH EG VEL TRACK

**Setting Range:** 0 ~ 100(%)

This allows you to adjust the depth of the pitch changing of the Pitch EG for the selected Component by keyboard velocity.

At “0” there is no change by key velocity. At “100” the pitch will change by a wide amount.

**NOTE:** The Pitch EG is explained in more detail on the next page.

## COMPONENT - PITCH EG

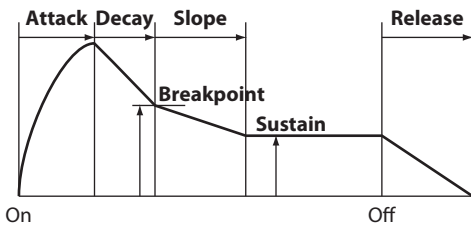

The EG (Envelope Generator) allows you to control how the sound changes over time by playing notes on the keyboard.

The illustration above illustrates the structure of the Envelope Generators for the PIANO/ENSEMBLE Section.

There are three (3) EG's: **Pitch**, **Filter** and **Amplitude**.

**NOTE:** The **PITCH EG DEPTH** Parameter must be set to some value other than "0" to hear the effect produced by the PITCH EG.

**NOTE:** Use the [DIRECTION] [▼] button to move the screen down to see the additional Parameters.

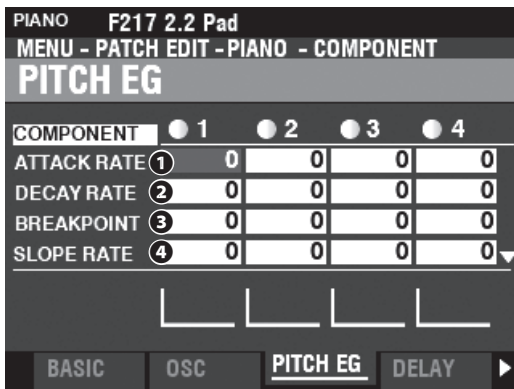

### 1 ATTACK RATE

Setting Range: 0 ~ 127

This allows you to adjust the time for the pitch to increase to its peak value beginning when a key is depressed.

### 2 DECAY RATE

Setting Range: 0 ~ 127

This allows you to adjust the time from the peak amount to the Breakpoint Level (explained below).

### 3 BREAKPOINT LEVEL

Setting Range: 0 ~ 127

This allows you to adjust the level of the point immediately following the Attack.

A higher value will set a higher pitch as the Breakpoint.

### 4 SLOPE RATE

Setting Range: 0 ~ 127

This allows you to adjust the time from the Breakpoint Level to the Sustain Level (explained below).

A higher value decreases the time required for the sound to return to the base frequency. A lower value increases the time.

### 5 SUSTAIN LEVEL

Setting Range: 0 ~ 127

This allows you to adjust the main level which will remain until the key is released.

A higher value will set a higher pitch as the Breakpoint.

### 6 RELEASE RATE

Setting Range: 0 ~ 127

This allows you to adjust the time for the level to fade from the Sustain Level to zero after the key is released.

A higher value will result in a longer Release time.

### 7 KEY TRACK ATTACK

### 8 KEY TRACK DECAY

### 9 KEY TRACK SLOPE

### 10 KEY TRACK RELEASE

Setting Range: 0 ~ 127

This allows you to adjust the rate and amount of the Pitch EG by note.

At "0" each note will sound the same Pitch EG. At "1 ~ 127" the rate and amount of Pitch EQ will be determined by the note being played. "127" will cause the envelope to respond by the maximum amount.

### 11 VEL TRACK ATTACK

### 12 VEL TRACK RELEASE

Setting Range: 0 ~ 127

This allows you to adjust the rate and amount of the Pitch EG by key velocity.

A higher velocity will result in a more pronounced EQ.

**NOTE:** The **Velocity Parameter** in the **COMBINATION Function Mode** must be "ON" (values 1 ~ 4) in order to hear the effect of **Velocity Tracking**.

## COMPONENT - DELAY

This allows you to adjust the note delay characteristics of the selected Component.

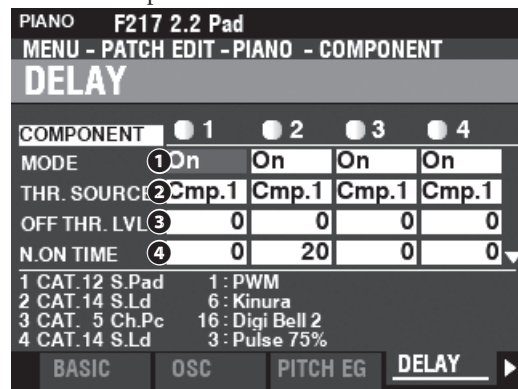

### 1 MODE

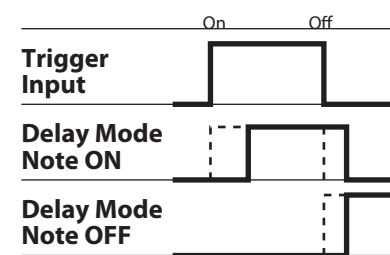

This allows you to select how the notes will sound.

**Note On** ..... When the note is "ON," the selected Component sounds at the Note On Delay Time. When the note is "OFF" the sound will stop after the Note Off Delay Time.

**Note Off Vel**.. The selected Component does not sound even if the note is "ON." If the note is "OFF," it will sounds if the Amplitude EG level of the referenced Component is above the Note Off Threshold Level. The velocity of the note will be determined by the velocity with which the key is depressed.

**Note Off EG**... Similar to Note Off Vel, except that the velocity of the note will be determined by the level of the Amplitude EG of the referenced Component.

**NOTE:** Using one of the "Note Off" settings may cause played notes to cipher or "stick on" To avoid this, set the Sustain Level of the Amplitude EG at "0" if you are using one of the "Note Off" settings.

**2 SOURCE**

**Settings: Cmp1, Cmp2, Cmp3, Cmp4**

This allows you to select the reference Component for the Delay settings.

The “Normal” setting is, the same Component selected as the one currently sounding.

**3 NOTE OFF THRESHOLD LEVEL**

**Setting Range: 0 ~ 127 : -∞ ~ 0 [dB]**

This allows you to adjust the Note Off level of the Amplitude EG of the reference Component.

**4 NOTE ON DELAY TIME**

**Setting Range: 0 ~ 127 : 0 ~ 5 [s]**

This allows you to adjust the time to sound the note after a key is depressed.

**5 NOTE OFF DELAY TIME**

**Setting Range: 0 ~ 127 : 0 ~ 5 [s]**

This allows you to adjust the time to hold the note before it stops sounding after the key is released.

**COMPONENT - FILTER**

The Filter allows you to control the basic timbre of the sound by selectively blocking some frequencies while allowing others to sound.

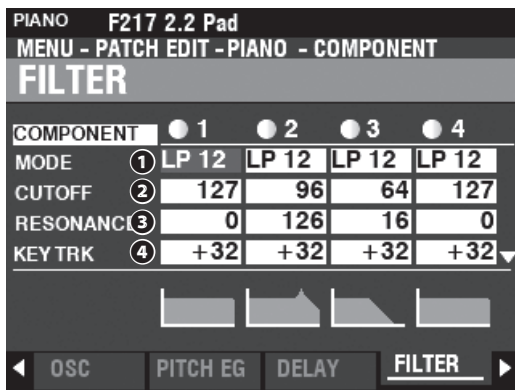

**1 MODE**

This allows you to select filter method.

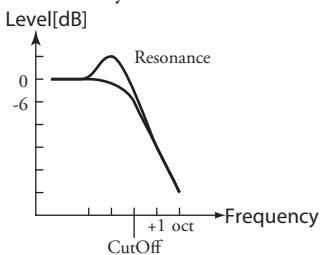

**LP12** ..... Low-Pass 12dB; It reduces above Cutoff Frequency at 12dB/octave.

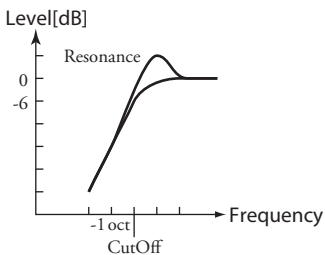

**HP12** ..... High-Pass 12dB; It reduces under Cutoff Frequency at 12dB/octave.

**2 CUTOFF FREQUENCY**

**Setting Range: 0 ~ 127**

This allows you to adjust the Cutoff Frequency of the Filter.

**3 RESONANCE**

**Setting Range: 0 ~ 127**

This allows you to add a controlled amplification to the Cutoff Frequency, coloring the original pitch.

**4 CUTOFF KEY TRACK**

**Setting Range: -100 ~ ±0 ~ +100 %**

This allows you to adjust the amount the Cutoff Frequency will change by note.

**5 EG DEPTH**

**Setting Range: -100 ~ ±0 ~ +100 %**

This allows you to adjust the amount the Cutoff Frequency will change by the Filter EG. At “0” the Cutoff Frequency does not change. At 100%, the Cutoff Frequency changes by a wide amount.

**6 EG VEL KEY TRACK**

**Setting Range: 0 ~ +100 %**

This allows you to adjust the amount of the Filter EG by Note “ON” or “OFF” velocities.

A lower key velocity will produce less of a Filter EQ. A higher velocity will produce a more pronounced EQ.

**COMPONENT - FILTER EG**

The Filter Envelope Generator allows you to control how the Filter will change the sound over time.

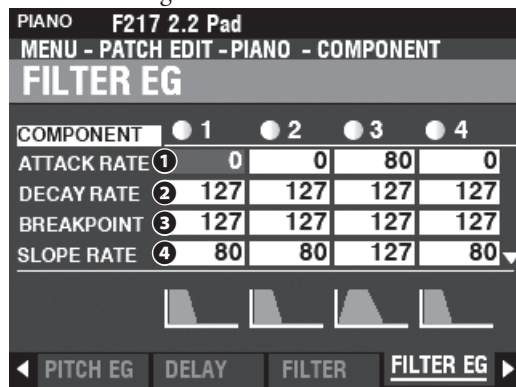

The Filter EG works in a manner similar to the Pitch EG (see page 95).

**COMPONENT - AMPLITUDE**

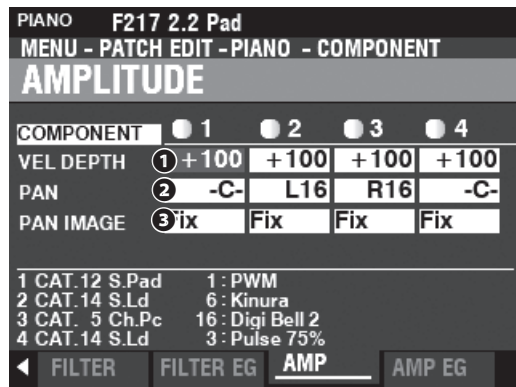



**1 VEL DEPTH**

**Setting Range:** -100 ~ +100 %

This allows you to adjust the amount of volume in response to key velocity.

At “0” there is no change in volume. At “+100%”, the volume is changed by the maximum amount corresponding to velocity.

**2 PAN**

**Setting Range:** L64 ~ C ~ R63

This allows you to adjust the directionality or Pan setting for the selected Component.

At “-C-” the sound is located in the center. At “L64” the sound will be in the Left channel only. At “R63” the sound will be in the Right channel only.

**3 PAN IMAGE**

This allows you to adjust the panning by the note.

- Fixed** .....No panning - all notes come from the center.
- L-R** .....Playing notes chromatically going up on the keyboard will cause the notes on the left to sound first.
- R-L** .....Playing notes chromatically going up on the keyboard will cause the notes on the right to sound first.
- Pyramid** .....Notes played chromatically going up on the keyboard will start in the center and alternate between left and right.
- Inverted** .....Notes played chromatically going up on the keyboard will start at one end and alternate between left and right until they meet in the center.

**COMPONENT - AMPLITUDE EG**

The Amplitude EG is an Envelope Generator affecting Volume.

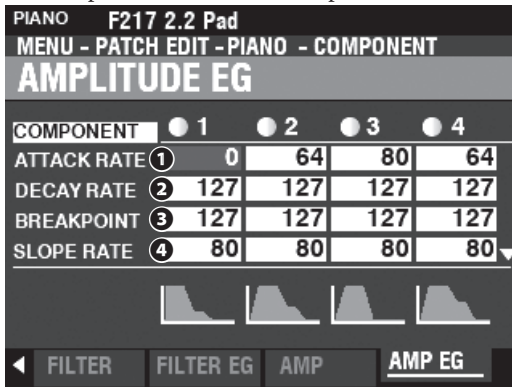

The Amplitude EG works similarly to the Pitch EG; however it has some additional Parameters which are explained below.

**NOTE:** Use the [DIRECTION] [▼] button to move the screen down to see the additional Parameters.

**13 ATTACK COEFFICIENT**

**14 DECAY COEFFICIENT**

**15 RELEASE COEFFICIENT**

**Setting Range:** 0 ~ 127

This allows you to adjust the contour for each envelope zone.

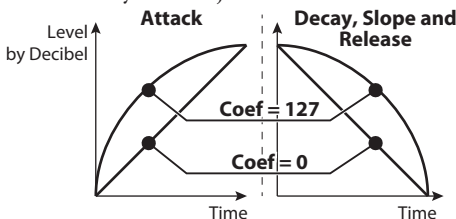

A higher value creates a linear taper suitable for an “upward” level. A lower value creates an exponential taper suitable for a “downward” level.

**NOTE:** The Decay Coefficient controls both Decay and Slope zones.

**MULTI EFFECT 1**

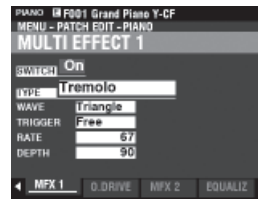

See “Multi Effects 1” (P. 106).

**OVERDRIVE**

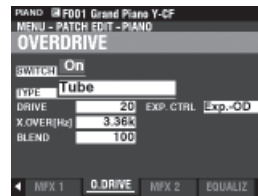

See “Overdrive.” (P. 111)

**MULTI EFFECT 2**

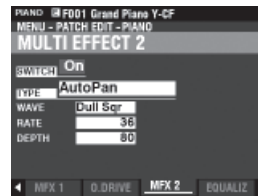

See “Multi Effects 2.” (P. 112)

**EQUALIZER**

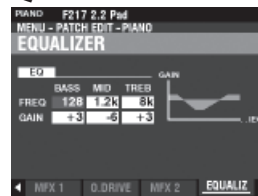

See “Equalizer.” (P. 116)

## COPYING A COMPONENT

To Copy all the Parameters from one Component to another, do the following.

### 1. OPEN THE PATCH FUNCTION MODE

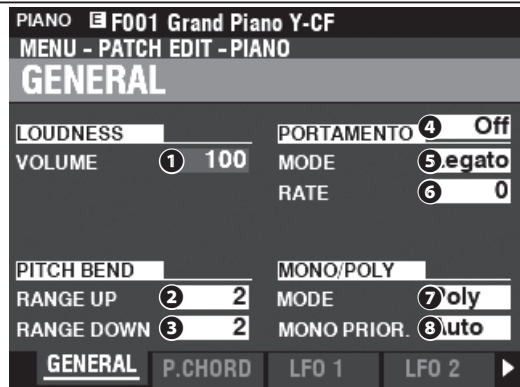

Press the [EDIT] button to open the FUNCTION Mode for the Voice Section you want.

### 2. OPEN THE APP (APPLICATION) MENU

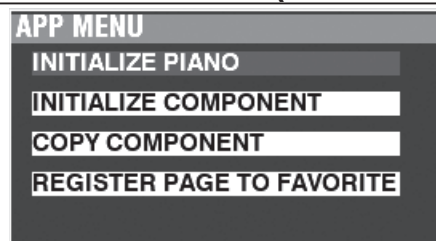

Press and Release the [≡] button to open the Application Menu.

### 2. SELECT "COPY COMPONENT"

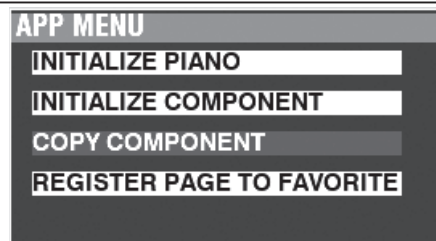

Use the [DIRECTION] [▼] button to move the cursor to "COPY COMPONENT" and press the [ENTER] button.

### 3. SELECT SOURCE AND DESTINATION

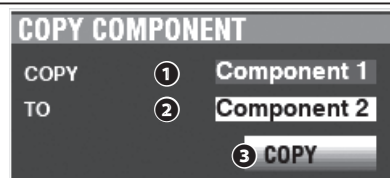

Select the Source and Destination to copy and press the [ENTER] button.

#### 1 COPY

Use the [VALUE] knob to select the Source (the Component to Copy from).

#### 2 TO

Use the [VALUE] knob to select the Destination (the Component to Copy to).

#### 3 COPY

After doing the above, use the [DIRECTION] [▼] button to move the cursor to the COPY icon and press the [ENTER] button.

## INITIALIZING A PATCH OR COMPONENT

Usually, the best way to create a custom Patch is to find a Patch which already contains most of what you want and edit only the Parameters necessary to create your custom Patch.

However, in some cases you may find it useful to clear the contents of a Patch or Component within a Patch completely and start with a "blank slate." In this case you can **Initialize** either a complete Patch or one of the four Components within a Patch. This is explained starting on the next page.

## COMPONENTS & POLYPHONY

**Polyphony** refers to the number of notes that can be played simultaneously. The PIANO and ENSEMBLE Voice Sections combined have a total polyphony of 128 notes. Also, the number of Components utilized in a Patch will affect the number of keys that can be played at one time before the 128-note limit is reached.

For example, Patches using a single Component can play 128 notes in response to 128 keypresses. However, some Patches utilize more than one Component. Patch #F209 "Soundtrack," for example, utilizes three (3) Components, meaning that pressing one key will cause 3 notes to play. Therefore, if 42 keys are pressed simultaneously the note limit will be reached. If the 128-note limit is exceeded, previously played notes will cancel or "drop out" so that the additional notes can be heard.

Even though some very dramatic effects can be created using more than one Component to create a custom Patch, it is recommended to be aware that using multiple Components will result in fewer keys that can be pressed simultaneously before the 128-note limit is reached.

## INITIALIZING A PATCH

To Initialize an entire Patch prior to editing, do the following:

### 1. OPEN THE PATCH FUNCTION MODE

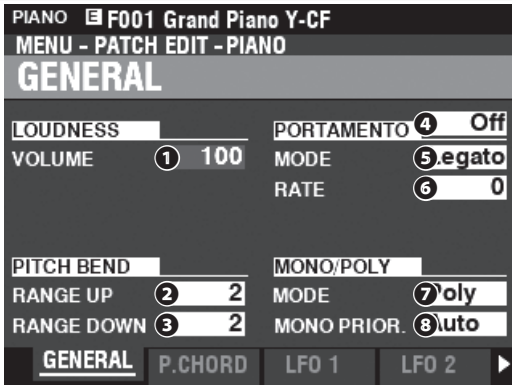

Press the [EDIT] button to open the FUNCTION Mode for the Voice Section you want.

### 2. OPEN THE APP (APPLICATION) MENU

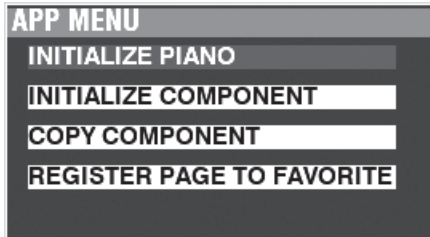

Press and Release the [≡] button to open the Application Menu.

### 3. SELECT "INITIALIZE (PIANO OR ENSEMBLE)"

Press the [ENTER] button.

### 4. SELECT PARAMETERS TO INITIALIZE

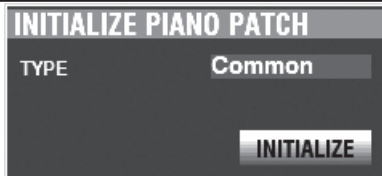

Use the [VALUE] knob to select the Parameters to initialize. Use the [DIRECTION] [▼] button to move the cursor to the [INITIALIZE] icon and press the [ENTER] button.

**Common**.....Parameters such as General, LFO, etc., excluding Components.

**All** ..... All Parameters including Components.

## INITIALIZING A COMPONENT

To Initialize an individual Component, do the following:

### 1. OPEN THE PATCH FUNCTION MODE

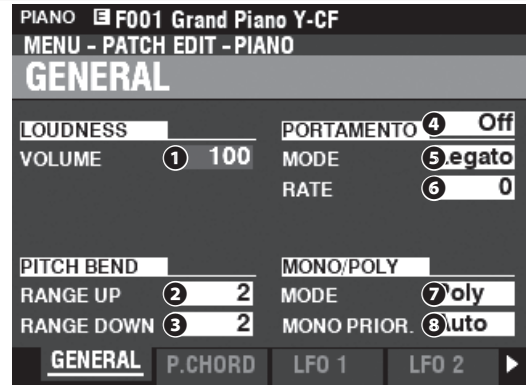

Press the [EDIT] button to open the FUNCTION Mode for the Voice Section you want.

### 2. OPEN THE APP (APPLICATION) MENU

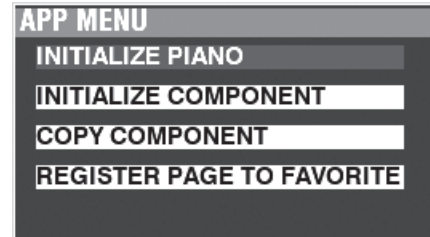

Press and Release the [≡] button to open the Application Menu.

### 3. SELECT "INITIALIZE COMPONENT"

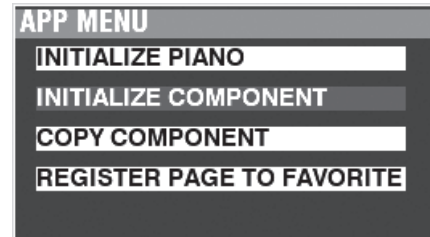

Use the [DIRECTION] [▼] button to move the cursor to [INITIALIZE COMPONENT] and press the [ENTER] button.

### 4. SELECT THE COMPONENT TO INITIALIZE



Use the [VALUE] knob to select the Component to initialize and press the [ENTER] button.

**1 to 4** ..... Each Component.

**All** ..... All the Components.

This FUNCTION Mode allows you to edit and create Patches in the MONO SYNTH Voice Section.

## TO LOCATE THIS MODE:

[MENU/EXIT] - **PATCH** - **SYNTH** - [ENTER]  
or press and hold the [OSC TYPE] button.

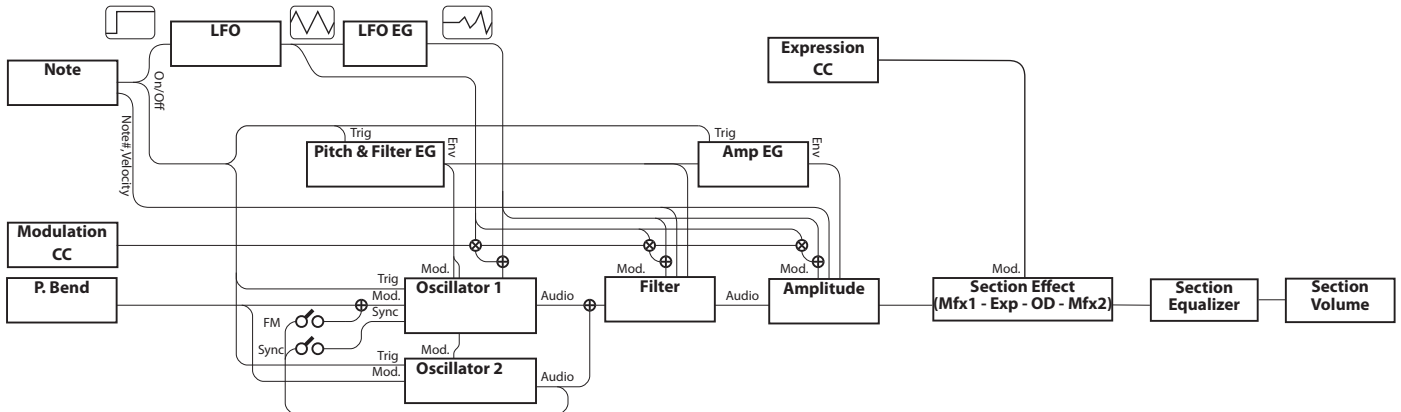

## EDITING THE MONO SYNTH SECTION

The MONO SYNTH Voice Section, as the name implies, is a monophonic synthesizer utilizing physical modeling. There are several individual “Oscillator Types” which can be selected.

The selected Oscillator Type can be modified by the Filter (timber), Amplitude (volume), Section Effects (Multi Effects and Overdrive) and the Equalizer.

Timed characteristics such as LFO and Envelope Generators for Pitch&Filter and Amplitude are also provided.

## PAGES AND PARAMETERS

### GENERAL

This Page allows you to adjust the common Parameters in this Patch.

#### 1. VOLUME

This allows you to adjust the volume.

#### 2. PORTAMENTO

This allows you to adjust Parameters for sliding the pitch between last note and present note.

#### 3. PITCH BEND

This allows you to adjust the range of the Pitch Bend.

### LFO

This Page allows you to adjust the LFO (Low Frequency Oscillator) which creates Vibrato or Tremolo effects, and their depth.

### OSCILLATOR

This allows you to adjust the oscillation method and pitch.

### FILTER

This allows you to adjust the filter Parameters.

### PITCH&FILTER EG

This allows you to adjust the Pitch&Filter envelope.

### AMPLITUDE

This allows you to adjust the Amplitude (volume) Parameters.

### AMP EG

This allows you to adjust the Amplitude Envelope.

### MULTI EFFECT 1

This allows you to adjust the **Multi Effects 1** (Tremolo, Wah-Wah, Ring Modulator, Compressor) for each MONO SYNTH Patch

### OVERDRIVE

This allows you to adjust the Overdrive settings for each Patch.

### MULTI EFFECT 2

This allows you to adjust the **Multi Effects 2** (AutoPan, Phaser, Flanger, Chorus, Delay) for each MONO SYNTH Patch.

### EQUALIZER

This allows you to adjust the Equalizer.

## APP (APPLICATION) MENU

The APP (Application) Menu allows you to select various Menu Pages quickly. To display the APP Menu:

1. Select SYNTH FUNCTION Mode.
2. Press and Release the [=] button. The Menu options shown below will display:

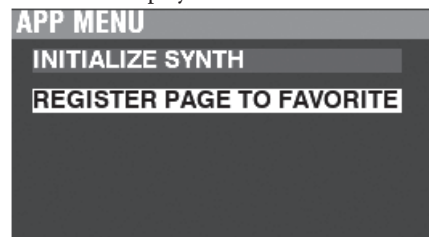

**INITIALIZE SYNTH** .....Initialize all the Patch Parameters in the present editing Patch.

**REGISTER PAGE TO FAV** .....Register present displayed page to the Favorites.

To select an option:

1. Use the [DIRECTION] [▲]/[▼] buttons to highlight the option you want.
2. Press the [ENTER] button to select the desired option.

## GENERAL

**SHORTCUT:** Press and Hold the OSCILLATOR [TYPE] button

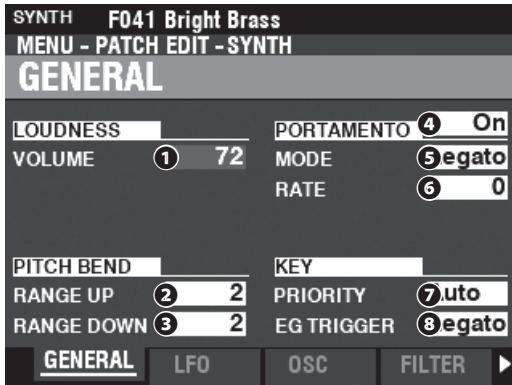

This Page allows you to adjust the common Parameters of a MONO SYNTH Patch.

**NOTE:** To see the MENU shown above after using the Shortcut, press the PAGE LEFT button two times.

### LOUDNESS

#### ① VOLUME

Setting Range: 0 ~ 127

This allows you to adjust the overall volume of the selected Patch.

### PITCH BEND

#### ② RANGE UP

Setting Range: 0 - 12 [semitones]

#### ③ RANGE DOWN

Setting Range: 0 - 24 [semitones]

These allow you to adjust the number of semitones the pitch of the selected Patch will bend "Up" or "Down" using the [PITCH BEND] wheel.

### PORTAMENTO

#### ④ SWITCH

Settings: Off, On

This allows you to turn the Portamento "ON" or "OFF".

#### ⑤ MODE

This allows you to adjust how to control the Portamento effect.

**Every**..... The Portamento will be heard with every keypress.

**Legato**..... The Portamento will be heard only when keys are played 'legato' (a key is depressed while another key is held).

#### ⑥ RATE

Setting Range: 0 ~ 127

This allows you to adjust the rate of the Portamento. A higher value will result in a slower Portamento.

### KEY

#### ⑦ PRIORITY

This allows you to adjust which note will sound if more than one note is played.

**Auto**..... Sounds highest note played when used with other Sections. Sounds last played note when used alone.

**Last**..... The last played note will sound.

**Lowest**..... The lowest note played will sound.

**Highest**..... The highest note played will sound.

#### ⑧ EG TRIGGER

This allows you to adjust whether the Envelope will reset each time a key is depressed.

**Note**..... The Envelope will start its cycle when a key is depressed.

**Free**..... Pressing a key will intercept the Envelope at whatever point it happens to be in its cycle.

# LFO

**SHORTCUT:** Press and Hold the [SHIFT] button and move the [LFO RATE] knob.

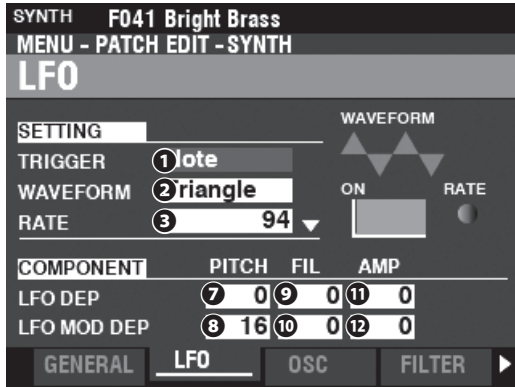

This Page allows you to adjust the “Low Frequency Oscillator” (LFO, which creates Vibrato or Tremolo effects) and its depth.

## 1 TRIGGER MODE

**Settings: Note, Free**

This allows you to adjust whether the phase of the LFO will reset each time a key is depressed.

**Note**..... The LFO of each note oscillates individually. Each LFO will start its cycle when a key is depressed.

**Free**..... Pressing a key will intercept the LFO at whatever point it happens to be in its cycle.

## 2 WAVEFORM

**Settings: See below**

This allows you to adjust the waveform of the LFO.

**Triangle** ..... Triangle wave.

**Square**..... Square wave Positive and Negative.

**Rectangle** ..... Square wave Positive and Zero.

**Saw Up**..... Sawtooth Upward wave.

**Saw Down**..... Sawtooth Downward wave

**S/H** ..... Sample and Hold.

**Fluctuation** ... Random.

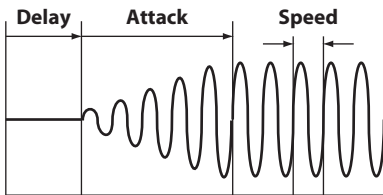

On

## 3 RATE

**Setting Range: 0 ~ 127**

This allows you to adjust the rate of the oscillation of the LFO.

## 4 DELAY TIME

**Setting Range: 0 ~ 127**

This allows you to adjust the amount of time before the LFO takes effect after a key is depressed.

## 5 ATTACK RATE

**Setting Range: 0 ~ 127**

This allows you to adjust the amount of time for the LFO to reach its full amount after a key is depressed.

## 6 ATTACK KEY TRACK

**Setting Range: -64 ~ 0 ~ +63**

This allows you to adjust how the Attack Rate is modulated by the note or pitch.

## 7 PITCH DEPTH

## 8 PITCH MOD DEPTH

## 9 FILTER DEPTH

## 10 FILTER MOD DEPTH

## 11 AMPLITUDE DEPTH

## 12 AMPLITUDE MOD DEPTH

These allow you to adjust the LFO depth by individual Parameters.

“MOD DEPTH ” sets the maximum LFO depth using the [MODULATION] wheel.

# OSCILLATOR

**SHORTCUT:** Press and Hold the [SHIFT] button and move the OSCILLATOR [PITCH] or [DEPTH] sliders.

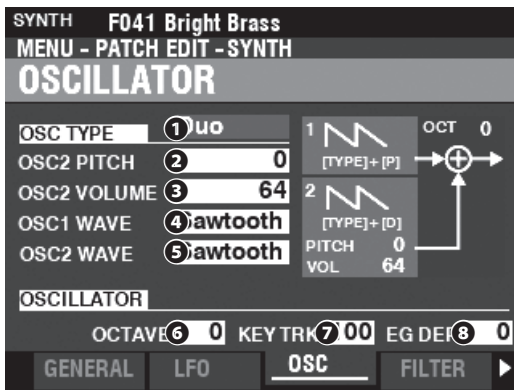

This Page allows you to adjust the oscillating method or pitch.

## 1 TYPE

This allows you to adjust the basic oscillating method.

**NOTE:** See page 53 “Oscillator Types And Characteristics” for details.

- Duo** ..... Two oscillators at different frequencies.
- Unison** ..... Several oscillators sounding in unison.
- Sync** ..... A single oscillator sounds synchronized with “out-of-tune” frequency.
- Pulse** ..... A single oscillator sound as a pulse wave.
- FM** ..... Frequency modulation between two (2) operators.
- Noise** ..... A single oscillator sounds various types of noise.

## 2 3 4 5 MODIFIERS

These Parameters allow you to modify various characteristics of the Oscillators.

**NOTE:** See page 53 “Oscillator Types And Characteristics” for details.

## 6 OCTAVE

**Setting Range:** -2 ~ ±0 ~ +2

This allows you to select the Octave or pitch at which the selected Oscillator will sound.

At “0” the selected Oscillator will sound at unison or actual pitch. “-2” will sound two octaves lower and “+2” will sound two octaves higher.

**NOTE:** This Parameter is linked to the [OCTAVE] buttons on the Control Panel.

## 7 KEY TRACK

**Setting Range:** ±0 ~ +100 [cents]

This allows you to adjust the amount of pitch change between keys on the keyboard.

At “+100” the musical distance between any two adjacent notes will be 100 cents or one half-step. This is the normal setting.

At “+50,” the notes will be one quarter-step apart. At “0” every note on the keyboard will sound the same pitch.

## 8 EG DEPTH

**Setting Range:** -64 ~ ±0 ~ +63

This allows you to adjust the depth of the pitch change by the Pitch Envelope.

At “0” there is no pitch change. At “-64,” the pitch will change down one octave. At “+63,” the pitch will change up one octave.

# FILTER

**SHORTCUT:** Press and Hold the [SHIFT] button and move the FILTER [CUT OFF], [RESONANCE] or [EG DEPTH] knobs.

This Page allow you to adjust the harmonic content of the sound.

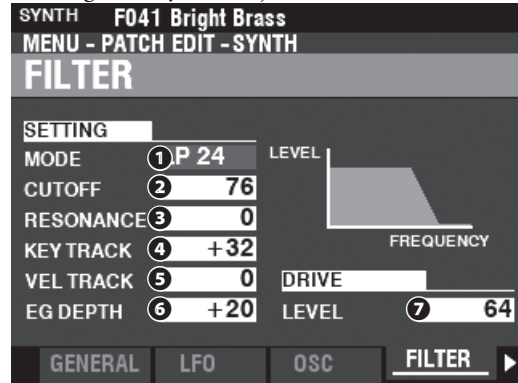

## 1 MODE

This allows you to select the filtering method.

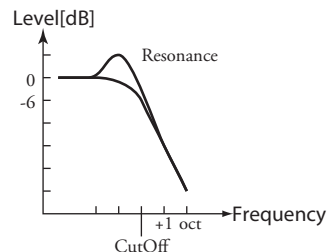

LP12/LP24..... Low-Pass 12(24)dB; reduces above the Cutoff Frequency at 12(24)dB/octave.

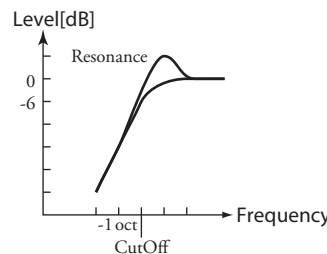

HP12/HP24..... High-Pass 12(24)dB; reduces below the Cutoff Frequency at 12(24)dB/octave.

## 2 CUTOFF FREQUENCY

**Setting Range:** 0 ~ 127

This allows you to adjust the Cutoff Frequency of the Filter.

## 3 RESONANCE

**Setting Range:** 0 ~ 127

This allows you to add a controlled amplification to the Cutoff Frequency, coloring the original pitch.

## 4 KEY TRACK

**Setting Range:** -64 ~ ±0 ~ +63

## 5 VEL TRACK

**Setting Range:** 0 ~ 127

These allow you to adjust the amount the Cutoff Frequency will change by note velocity.

**NOTE:** The Velocity Parameter in the COMBINATION Function Mode must be “ON” (values 1 ~ 4) in order to hear the effect of Velocity Key Tracking.

**6 EG DEPTH**

**Setting Range:** -64 ~ ±0 ~ +63

This allows you to adjust the amount of the changing Cutoff Frequency by the Filter EG.

At “0” the Cutoff Frequency does not change. At “-64” or “+63,” the Cutoff Frequency changes by a wide amount.

**7 DRIVE LEVEL**

**Setting Range:** 0 ~ 127

This allows you to adjust the signal level going into the Filter. “64” is a “clean” signal with no distortion. A higher value adds distortion.

**PITCH & FILTER EG**

**SHORTCUT:** Press and Hold the [SHIFT] button and move the PITCH & FILTER ENVELOPE [ATTACK], [DECAY], [SUSTAIN] or [RELEASE] sliders.

The EG (Envelope Generator) allows you to control how the sound changes over time.

This EG affects both the Pitch and the Cutoff Frequency of the Filter.

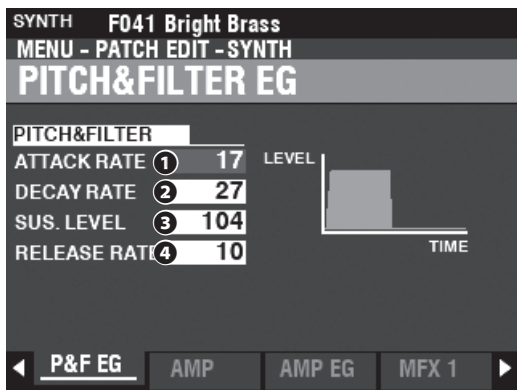
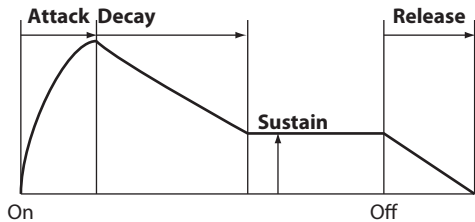

**1 ATTACK RATE**

**Setting Range:** 0 ~ 127

This allows you to adjust the time for the sound to increase to its peak value beginning when a key is depressed. A higher value will result in a slower Attack Rate.

**2 DECAY RATE**

**Setting Range:** 0 ~ 127

This allows you to adjust the time from the peak amount to the Sustain Level (explained below). A higher value will result in a longer Decay Rate.

**3 SUSTAIN LEVEL**

**Setting Range:** 0 ~ 127

This allows you to adjust the main level which will remain until the key is released. A higher value will result in a higher Sustain Level.

**4 RELEASE RATE**

**Setting Range:** 0 ~ 127

This allows you to adjust the time for the level to fade from the Sustain Level to zero after the key is released. A higher value will result in a longer Release time.

**AMPLITUDE**

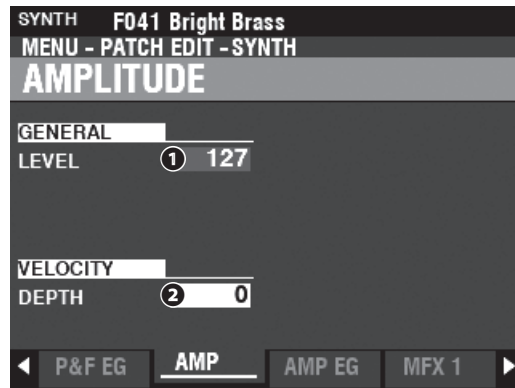

This Page allows you to adjust the Parameters controlling loudness.

**1 OUTPUT LEVEL**

**Setting Range:** 0 ~ 127

This allows you to adjust the overall volume.

**2 VELOCITY DEPTH**

**Setting Range:** 0 ~ 127

This allows you to adjust how the volume changes by keyboard velocity.

At “0” there is no change in velocity. At “127,” the volume is changed by the maximum amount in proportion to the velocity.

**AMPLITUDE EG**

**SHORTCUT:** Press and Hold the [SHIFT] button and move the AMPLITUDE ENVELOPE [ATTACK], [DECAY], [SUSTAIN] or [RELEASE] sliders.

The Amplitude EG is an Envelope Generator which affects Volume. It works in a manner similar to the Pitch&Filter EG's.

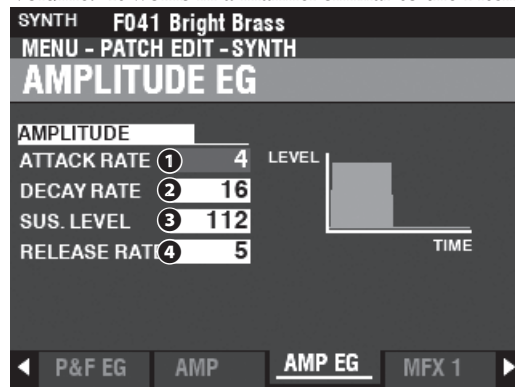



## MULTI EFFECT 1

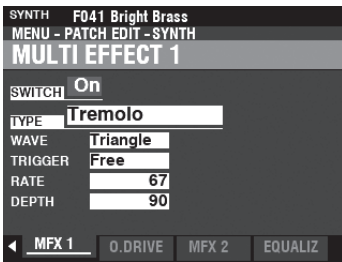

See “Multi Effects 1.” (P. 106)

## OVERDRIVE

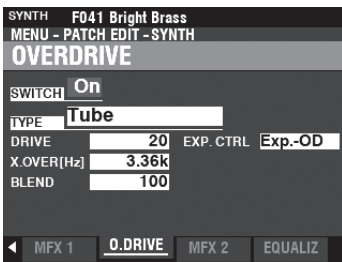

See “Overdrive.” (P. 111)

## MULTI EFFECT 2

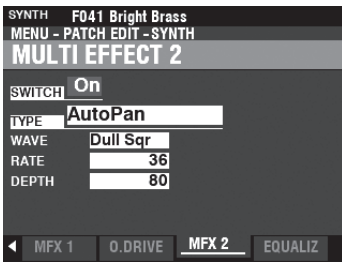

See “Multi Effects 2.” (P. 112)

## EQUALIZER

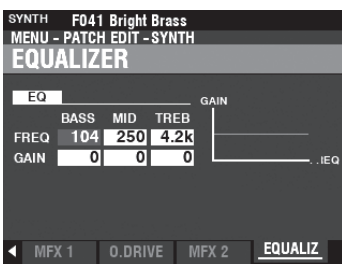

See “Equalizer.” (P. 116)

# SECTION EFFECTS

The following pages will explain the Effects for each Voice Section, which are **Multi Effects 1**, **Overdrive**, **Multi Effects 2** and **Equalizer**. Each Section has its own adjustments for these Effects.

## TO LOCATE THIS MODE:

[MENU/EXIT] - **PATCH** - each Section - [ENTER] - **MFx1 / O. DRIVE / MFx2**

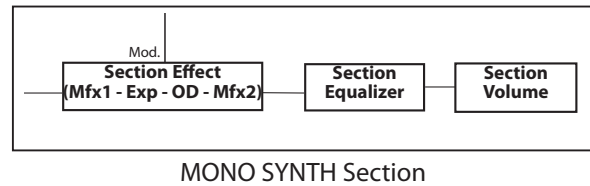
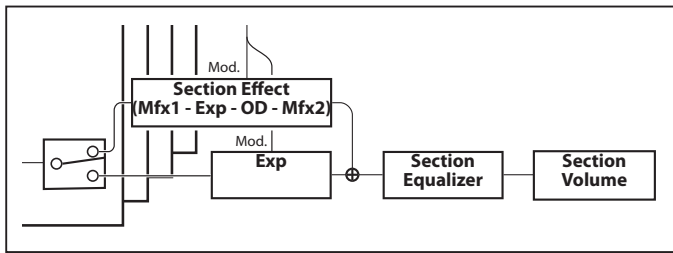
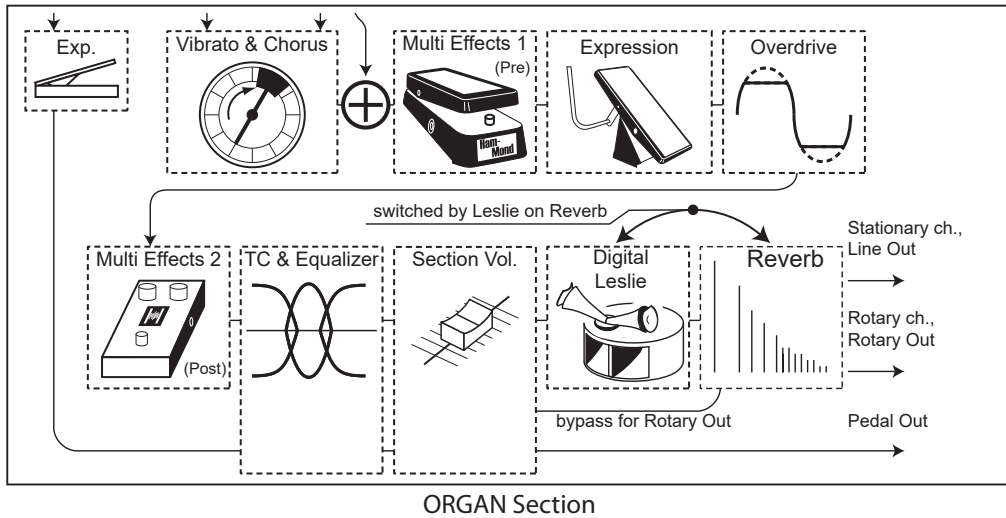

## MULTI EFFECT 1

**Multi Effect 1** contains effects which are inserted at pre-Overdrive or Expression.

See page 107 for more information about Multi Effects 1.

## OVERDRIVE

**Overdrive** adds distortion to the sound by increasing the pre-amplifier input gain.

See page 111 for more information about Overdrive.

## MULTI EFFECT 2

**Multi Effect 2** contains the effects which are placed after the Expression or Overdrive effect.

See page 112 for more information about Multi Effects 2.

## EQUALIZER

An **Equalizer** is used to adjust the tonal quality. Each of the four Voice Sections has its own Equalizer.

See page 116 for more information about the Equalizer.

## MULTI EFFECT 1

**Multi Effect 1** contains the effects listed below which are inserted at pre-Overdrive or Expression.

### TREMOLO

**Tremolo** is a periodic raising and lowering of the amplitude or volume at a determined rate.

### WAH-WAH

**Wah-Wah** is a periodic emphasis and de-emphasis of upper frequencies by means of a frequency filter to impart a speech-like quality to the sound.

### RING MODULATOR

**Ring Modulation** is a signal-processing effect whereby two different frequencies are mixed together in such a way as to reduce or eliminate the individual frequencies themselves, leaving only the sum and the difference of the two frequencies.

### COMPRESSOR

**Compressor** detects the volume of the source, and reduces or emphasizes the amount of volume change.

## MULTI EFFECT 1

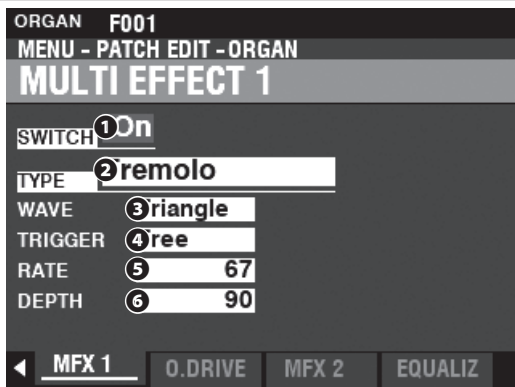

#### 1 SWITCH

Settings: Off, On

This allows you to turn a Multi Effect “ON” or “OFF.”

#### 2 TYPE

Settings: Tremolo, Wah-Wah, Ring Mod., Compressor

This allows you to select a Multi Effect.

Each Multi Effect has different Parameters. This is explained starting at the right column.

## Tremolo

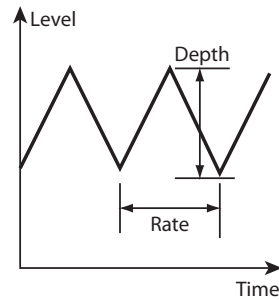

#### 3 WAVEFORM

This allows you to set which waveform is used to modulate the volume.

**Triangle** ..... Triangle wave.

**Square** ..... Square wave.

**Saw Down** ..... Sawtooth Downward wave.

**S & H** ..... Sample and Hold.

**Dull Sqr** ..... Dull Square wave.

#### 4 TRIGGER

This allows you to adjust whether the phase of the modulating waveform will reset each time a key is depressed.

**Free** ..... Pressing a key will intercept the LFO at whatever point it happens to be in its cycle.

**Single** ..... The LFO of each note oscillates individually. Each LFO will start its cycle when a key is depressed.

#### 5 RATE

Setting Range: 0 ~ 127

This allows you to adjust the modulation rate.

A higher value results in a faster rate.

#### 6 DEPTH

Setting Range: 0 ~ 127

This allows you to adjust the depth of the modulation.

At “0” there is no change in volume. The depth increases as the value increases. At “127” the Tremolo alternates between no sound and maximum volume.

## Wah-Wah

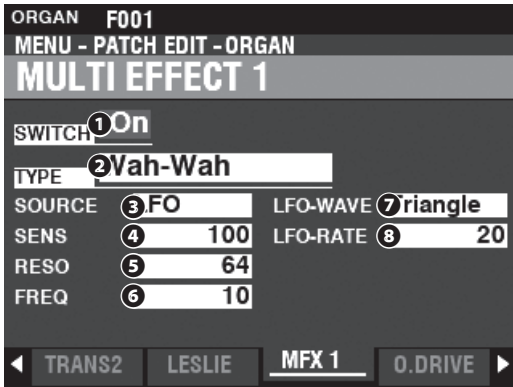

### 3 SOURCE

**Settings:** Mod, Exp, LFO, Input

This allows you to select how to modulate the Wah-Wah effect.

**Mod** .....Allows you to use the [MODULATION] wheel.

**Exp** .....Allows you to use the Expression Pedal.

**LFO** .....Allows a cyclical modulation using a dedicated LFO-Low Frequency Oscillator.

**Input** .....Allows you to use the input audio envelope of the sound engine.

### 4 SENSITIVITY

**Setting Range:** 0 ~ 127

This allows you to adjust the sensitivity or width of the effect.

A higher value results in a wider dynamic response.

### 5 RESONANCE

**Setting Range:** 0 ~ 127

This allows you to boost the cut-off frequency of the Low-Pass Filter and create a more pronounced “Wah” effect.

A higher value results in a greater resonance.

### 6 FREQUENCY

**Setting Range:** 0 ~ 127

This allows you to adjust the central frequency.

A higher value increases the frequency.

### 7 LFO WAVEFORM

**Settings:** Triangle, Square, Saw Down, S & H

This allows you to select the waveform of the LFO.

**Triangle** ..... Triangle wave.

**Square** ..... Square wave.

**Saw Down** ..... Sawtooth Downward wave.

**S & H** ..... Sample and Hold.

**NOTE:** The SOURCE must be set to “LFO” to use this Parameter.

### 8 LFO RATE

**Setting Range:** 0 ~ 127

This allows you to adjust the rate of the LFO.

A higher value results in a faster rate.

**NOTE:** The SOURCE must be set to “LFO” to use this Parameter.

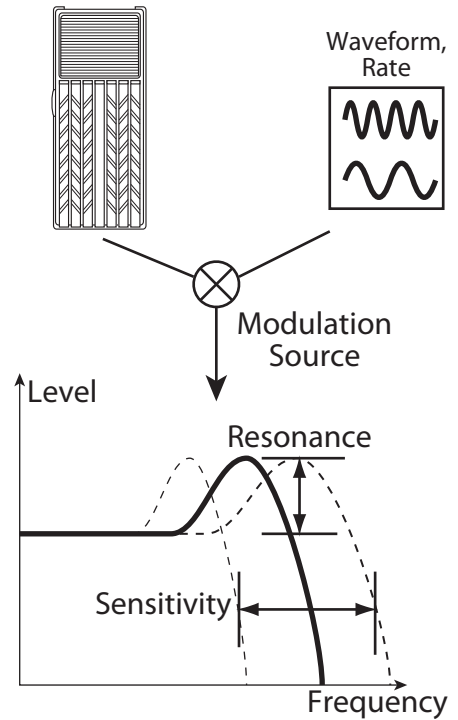

## Ring Modulator (Ring Mod.)

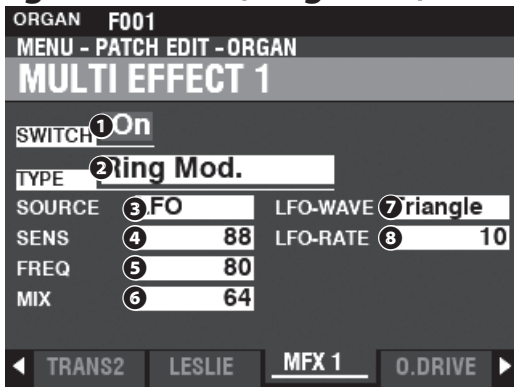

### tips RING MODULATION

“Ring modulation” in analog circuits is accomplished by arranging diodes in a circle or ring, giving rise to the term, “ring modulator.” The result is a sound rich in overtones and typically having somewhat of a bell-like or metallic quality. Because of this, the sound is sometimes called a “Klang tone.”

#### 3 SOURCE

**Settings: Mod, Exp, LFO, Note**

This allows you to select how to modulate the ring frequency.

**Mod** .....Allows you to use the [MODULATION] wheel.

**Exp** .....Allows you to use the Expression Pedal.

**LFO** .....Allows a cyclical modulation effect using a dedicated LFO-Low Frequency Oscillator.

**Note** .....Allows you to use a note on the UPPER Keyboard.

#### 4 SENSITIVITY

**Setting Range: 0 ~ 127**

This allows you to adjust the sensitivity or width of the LFO.

A higher value results in a wider excursion of the LFO.

**NOTE: The SOURCE must be set to “LFO” to hear this effect.**

#### 5 FREQUENCY

**Setting Range: 0 ~ 127**

This allows you to adjust the central ring frequency.

A higher value results in a higher central frequency.

#### 6 MIX

**Setting Range: 0 ~ 127**

This allows you to adjust the volume balance between the “dry” and the effect sounds.

At “0” only the “dry” sound is heard. The effect level becomes greater as the value increases. At “64” the ratio between the “dry” and the effect sounds becomes 1:1. At “127,” only the effect sound is heard.

#### 7 LFO WAVEFORM

**Settings: Triangle, Square, Saw Up, S & H**

This allows you to select the waveform of the LFO.

**Triangle** ..... Triangle wave.

**Square** ..... Square wave.

**Saw Up** ..... Sawtooth Upward wave.

**S & H** ..... Sample and Hold.

**NOTE: The SOURCE must be set to “LFO” to use this Parameter.**

#### 8 LFO RATE

**Setting Range: 0 ~ 127**

This allows you to adjust the rate of the LFO.

A higher value results in a faster rate.

**NOTE: The SOURCE must be set to “LFO” to hear this effect.**

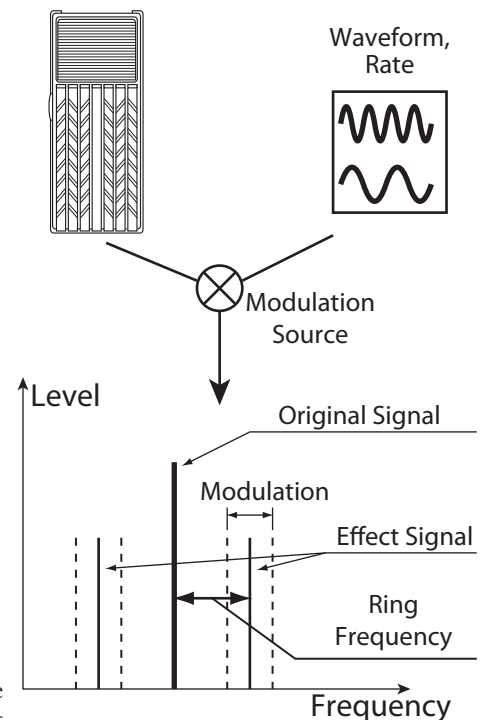

## Compressor

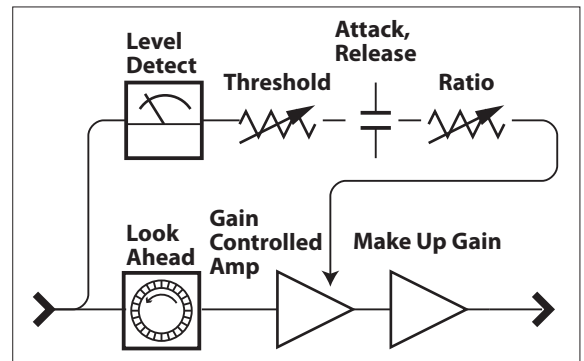
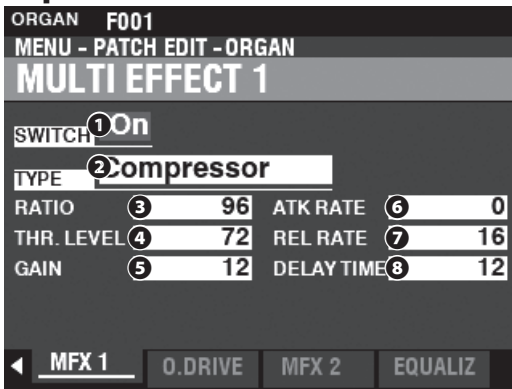

### 3 RATIO RATE

**Setting Range:** 0 ~ 127 (1:1 ~ ∞:1)

This allows you to adjust the rate at which the volume changes between input and output.

A higher value results in a lesser change of volume.

### 4 THRESHOLD LEVEL

**Setting Range:** 0 ~ 127 (-24 ~ ±0 [dB])

This allows you to adjust the value of the input level at which reduction begins.

A lower value results in compression beginning at a lower input level.

### 5 OUTPUT GAIN

**Setting Range:** 0 ~ 127 (0 ~ +24 [dB])

This allows you to increase the volume to a level to be reduced by the compression process.

A higher value results in a higher volume.

### 6 ATTACK RATE

**Setting Range:** 0 ~ 127

This allows you to adjust the rate at which the volume is reduced when the input sound exceeds the threshold level.

A higher value results in a slower reduction rate and the Attack of the sound is emphasized.

### 7 RELEASE RATE

**Setting Range:** 0 ~ 127

This allows you to adjust the rate at which the volume is reduced when the input sound is lower than the threshold level.

A higher value results in a slower release time and the Return gain is delayed.

### 8 DELAY TIME

**Setting Range:** 0 ~ 127

This allows you to adjust the amount of time before compression takes effect after a key is depressed.

A higher value results in a longer delay.

**NOTE:** This Parameter also results in faster Attack and Release times.

## OVERDRIVE

On the SK PRO, the Overdrive feature is turned “ON and OFF” by the [OVERDRIVE] button. Both the type and amount of Overdrive are controlled by Parameters.

**NOTE:** The [OVERDRIVE] Touch Button must be “ON” in order to hear the Overdrive effect.

**NOTE:** The Overdrive is placed between Multi Effect “1” and Multi Effect “2.”

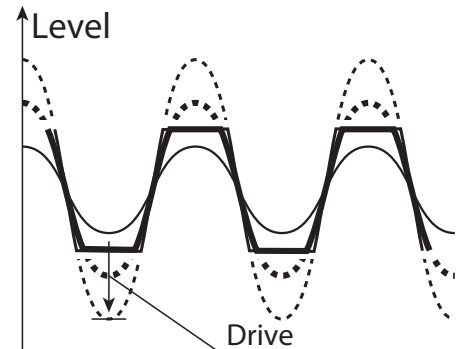
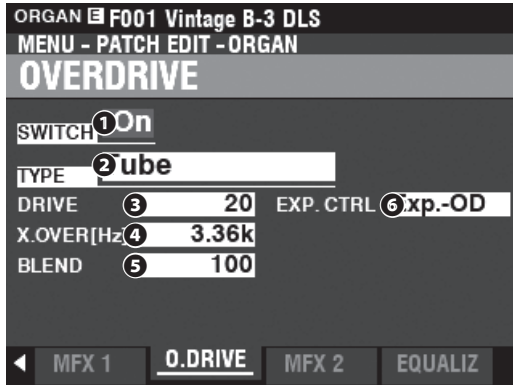

### 1 SWITCH

Settings: Off, On

This allows you to turn Overdrive “ON” or “OFF.”

### 2 TYPE

Settings: Tube, Solid, Clip

This allows you to adjust the character of the Overdrive.

**Tube** ..... Soft clipped sound similar to a vacuum tube (valve) amplifier.

**Solid** ..... Hard clipped sound similar to a solid state amplifier.

**Clip** ..... Precision hard-clipped sound.

**EP Amp** ..... Soft clipped sound similar to the amplifier of an Electric Piano.

### 3 DRIVE

Setting Range: 0 ~ 127

This allows you to adjust the amount of the distortion.

A higher value results in more distortion.

### 4 CROSSOVER FREQUENCY

Setting Range: 400 ~ 14.7k [Hz]

This allows you to adjust the upper limit of the frequency range receiving Overdrive.

### 5 BLEND

Setting Range: 0 ~ 127

This allows you to adjust the balance between dry and Overdriven sounds.

At “0” the sound is “dry.” At “127,” only the Overdriven sound is heard. The numbers in between allow mixing of dry and Overdriven sounds.

**NOTE:** The mixing rate may not always be “1:1” if the value is set at 64 due to different envelopes between dry and Overdriven sounds.

### 6 EXPRESSION CONTROL

This allows you to adjust the relation between Expression and the Overdrive effect.

**EX-OD** ..... Both volume and distortion will be changed by the Expression.

**OD-EX** ..... Only volume will be changed by the Expression.

**OD Only** ..... Only distortion will be changed by the Expression.

**Input** ..... Similar to OD ONLY, but with a smaller amount of change.

### tips CROSSOVER FREQUENCY

In addition to distortion, the Overdrive effect also introduces harmonics (overtones) into the sound. Some of these harmonics may be undesirable and create harmonic interference between dry and overdriven sounds.

By using the Crossover Frequency Parameter to limit the amount of upper frequencies receiving Overdrive, you can minimize or eliminate harmonic interference and create a more pleasing sound.

## MULTI EFFECT 2

**Multi Effect 2** contains the effects listed below and are placed after the Expression or Overdrive effect.

### AUTO PAN

**Auto Pan** smoothly shifts the sound back and forth between Left and Right channels.

### PHASER

**Phaser** will create the effect of splitting an audio signal into two paths and varying their phase relationship to each other, resulting in an alternately hollow and full-bodied sound. It can be described as a “swooshing” or “twisting” effect.

### FLANGER

**Flanging** occurs when two identical signals are mixed together, and one of the signals is time-delayed by a very small amount.

### CHORUS

**Chorus** refers to a shimmering, non-periodic enhancement of the sound. It is intended to be similar to several instruments sounding in unison, and is helpful when a thicker tonal texture is desired.

### DELAY

**Delay** adds echo effects.

## MULTI EFFECT 2

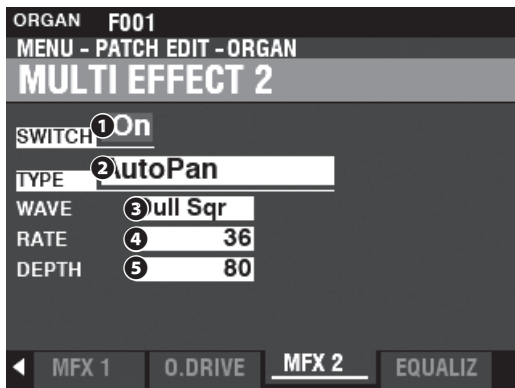

#### 1 SWITCH

**Settings:** Off, On

This allows you to turn a Multi Effect “ON” or “OFF.”

#### 2 TYPE

**Setting Range:** Auto Pan, Phaser, Flanger, Chorus, Delay

This allows you to select a Multi Effect.

Each Multi Effect has different Parameters. This is explained starting at the right column.

## Auto Pan

**NOTE:** This Parameter is not applicable if a monophonic (single channel) sound system is used or a Leslie Speaker Cabinet is connected.

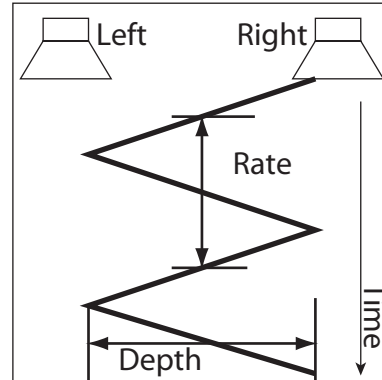

#### 3 WAVEFORM

**Settings:** Triangle, Square, L to R, S & H, Dull Sqr

This allows you to select the waveform which will modulate the selected sound.

**Triangle** ..... Triangle wave.

**Square** ..... Square wave.

**L to R** ..... Left to Right.

**S & H** ..... Sample and Hold.

**Dull Sqr** ..... Dull Square wave.

#### 4 RATE

**Setting Range:** 0 ~ 127

This allows you to adjust the rate of the modulation.

A higher value results in a faster rate.

#### 5 DEPTH

**Setting Range:** 0 ~ 127

This allows you to adjust the depth of the modulation.

At “0” there is zero panning. A higher value results in wider panning.



## Phaser

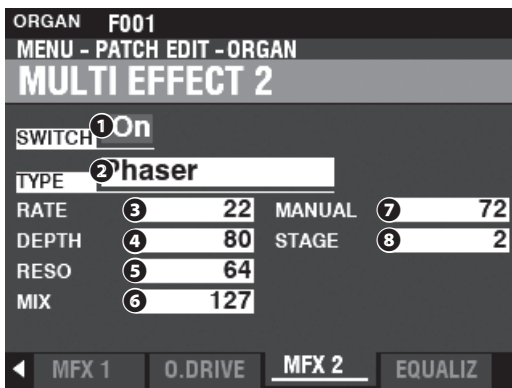
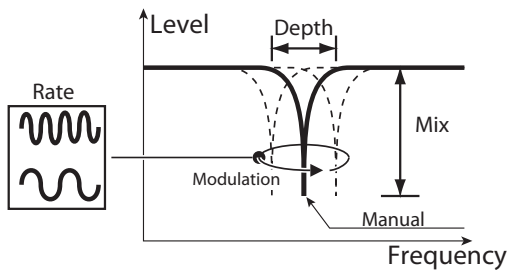

### 3 RATE

**Setting Range:** 0 ~ 127

This allows you to adjust the frequency rate.  
A higher value results in a faster rate.

### 4 DEPTH

**Setting Range:** 0 ~ 127

This allows you to adjust the depth of the modulation.  
A higher value results in a deeper modulation.

### 5 RESONANCE

**Setting Range:** 0 ~ 127

This allows you to adjust the resonance (feed-back) amount.  
A higher value results in a greater resonance.

**NOTE:** At higher values, the sound may be modulated to the point the base frequency is no longer audible.

### 6 MIX

**Setting Range:** 0 ~ 127

This allows you to adjust the volume balance between the “dry” and the effect sounds.

At “0” only the “dry” sound is heard. The effect level becomes greater as the value increases. At “64” the ratio between the “dry” and the effect sounds becomes 1:1. At “127,” only the effect sound is heard.

### 7 MANUAL

**Setting Range:** 0 ~ 127

This allows you to set the middle frequency of the phase effect.  
A higher value results in a higher frequency.

### 8 STAGE

**Setting Range:** 2, 4, 6, 8, 10

This allows you to adjust the complexity or “stage” of the phasing.  
A higher value creates more complex effects.

## Flanger

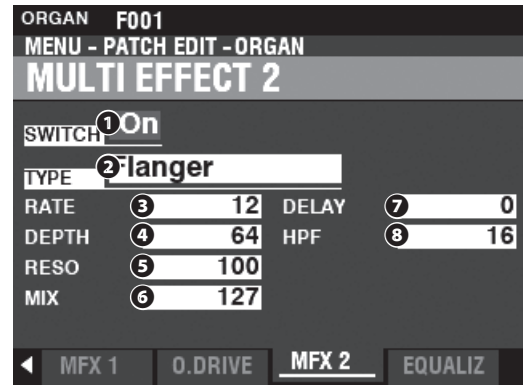
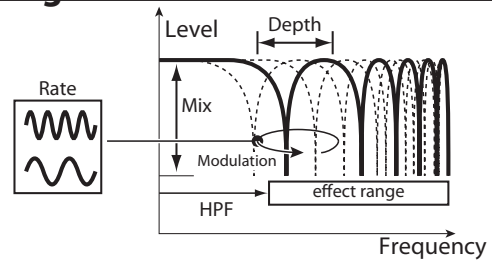

### 3 RATE

**Setting Range:** 0 ~ 127

This allows you to adjust the modulation rate.  
A higher value results in a faster rate.

### 4 DEPTH

**Setting Range:** 0 ~ 127

This allows you to adjust the depth of the modulation.  
A higher value results in a deeper modulation.

### 5 RESONANCE

**Setting Range:** 0 ~ 127

This allows you to adjust the resonance (feed-back) amount.  
A higher value results in a greater resonance.

### 7 MIX

**Setting Range:** 0 ~ 127

This allows you to adjust the volume balance between the “dry” and the effect sounds.

At “0” only the “dry” sound is heard. The effect level becomes greater as the value increases. At “64” the ratio between the “dry” and the effect sounds becomes 1:1. At “127,” only the effect sound is heard.

### 6 DELAY

**Setting Range:** 0 ~ 127

This allows you to control the delay of the effect sound.  
A higher value results in a longer delay.

### 8 HPF (High Pass Filter)

**Setting Range:** 0 ~ 127

This allows you to control the frequency range of the effect.  
At “0” the effect is added to all frequencies. The effect is added to the higher frequencies as the value increases.

## Chorus

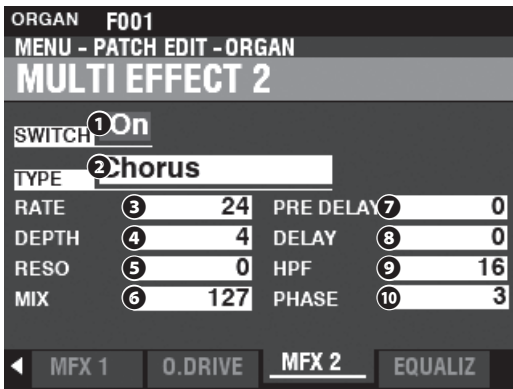

### 3 RATE

**Setting Range:** 0 ~ 127

This allows you to adjust the rate of the rising and falling effect. A higher value results in a faster rate.

### 4 DEPTH

**Setting Range:** 0 ~ 127

This allows you to adjust the modulation depth. A higher value results in a deeper modulation.

### 5 RESONANCE

**Setting Range:** 0 ~ 127

This allows you to adjust the resonance (feed-back) amount. A higher value results in a greater resonance.

### 6 MIX

**Setting Range:** 0 ~ 127

This allows you to adjust the volume balance between the “dry” and the effect sounds. At “0” only the “dry” sound is heard. The effect level becomes greater as the value increases. At “64” the ratio between the “dry” and the effect sounds becomes 1:1. At “127,” only the effect sound is heard.

### 7 PRE-DELAY

**Setting Range:** 0 ~ 127

This allows you to delay the signal for a channel even if the source is Monaural. A higher value creates a time difference between Left and Right to the effect sound.

### 8 DELAY

**Setting Range:** 0 ~ 127

This allows you to control the delay of the effect sound. A higher value results in a greater delay.

### 9 HPF (High Pass Filter)

**Setting Range:** 0 ~ 127

This allows you to control the frequency range of the effect. At “0” the effect is added to all frequencies. The effect is added to the higher frequencies as the value increases.

### 10 PHASE

**Settings:** 2, 3

This allows you to select the algorithm of the Chorus effect.

- 2 ..... two-phase.
- 3 ..... three-phase.

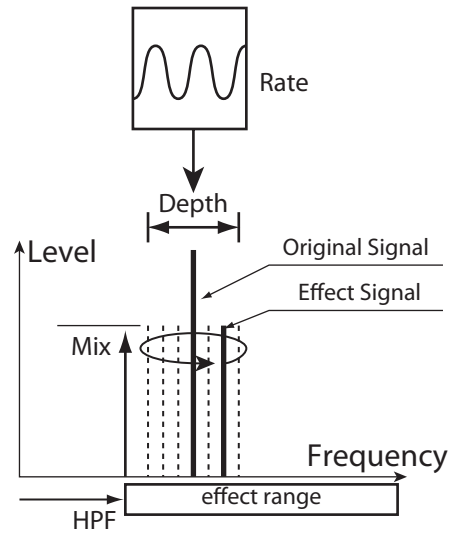

## Delay

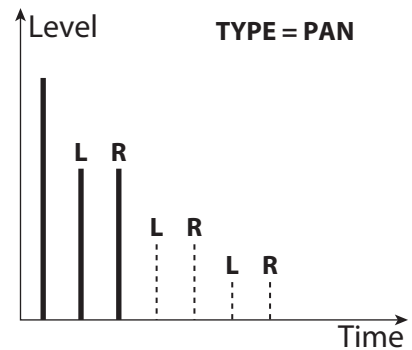
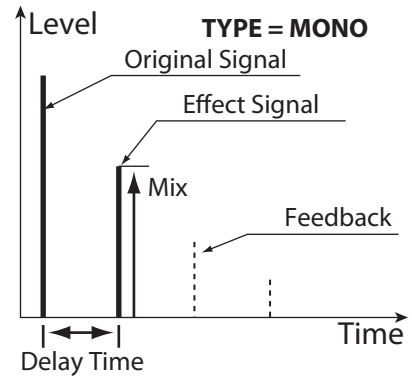
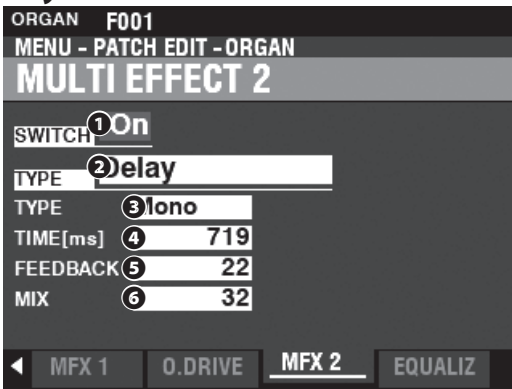

**3 TYPE**

**Settings: Mono, RtoL, LtoR**

This allows you to select how sounds are reflected.

**Mono** .....A simple monophonic "echo"

**RtoL, LtoR**..... The delay is alternated in the stereo field. At "RtoL" the delayed sound comes from the right. At "LtoR" the delayed sound comes from the left.

**NOTE: This is not applicable if a monophonic (single channel) sound system is used or a Leslie Speaker Cabinet is connected.**

**4 TIME**

**Setting Range: 10 ~ 1000 [ms]**

This allows you to adjust the delay time.

A higher value results in a longer delay time

**5 FEEDBACK**

**Setting Range: 0 ~ 127**

This allows you to adjust the number of repetitions of the effect sound.

A higher value results in a greater number of repetitions.

**6 MIX**

**Setting Range: 0 ~ 127**

This allows you to adjust the volume balance between the "dry" and the effect sounds.

At "0" only the "dry" sound is heard. The effect level becomes greater as the value increases. At "64" the ratio between the "dry" and the effect sounds becomes 1:1. At "127," only the effect sound is heard.

# EQUALIZER

An Equalizer is used to adjust the tonal quality. The built-in Equalizer on the SK PRO consists of 3 bands. The Bass and Treble bands are handled by “shelf” equalizers, and the Mid band is handled by parametric control.

Each of the four Voice Sections has its own Equalizer, and there is also a Master Equalizer which adjusts the tonal quality for the entire instrument.

## TO LOCATE THE EQUALIZER FOR EACH VOICE SECTION:

[MENU/EXIT] - **PATCH** - each Section - [ENTER] - **EQUALIZER**

## TO LOCATE THE MASTER EQUALIZER:

[MENU/EXIT] - **SYSTEM** - **SOUND** - [ENTER] - **MASTER EQUALIZER**

## SECTION EQUALIZER

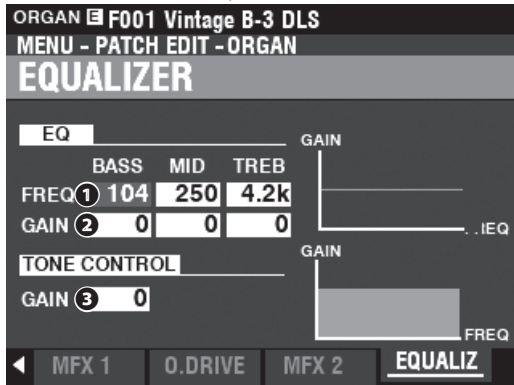

This Page allows you to adjust the settings for the Equalizer in each Voice Section (ORGAN Section shown).

### 1 FREQUENCY

**Setting Range:** 20 ~ 308 [Hz] (BASS)  
250 ~ 3.1k [Hz] (MID)  
3k ~ 8k [Hz] (TREB)

These allow you to adjust the center or “turnover” frequency to be attenuated for BASS, MID and TREBLE respectively.

### 2 GAIN

**Setting Range:** -9 ~ ±0 ~ +9 [dB]

These allow you to adjust the Boost/Cut of BASS, MID and TREBLE respectively.

**NOTE:** At “0” the frequency response is “flat.”

### 3 TONE CONTROL (ORGAN Voice Section only)

**Setting Range:** -9 ~ ±0 ~ +9 [dB]

This Parameter duplicates the performance of the tone control on the AO-28 preamp of a B-3 or C-3. Its response is unique, to cut the overall treble above 200Hz gently.

The setting range is -9 to +3, and it becomes neutral when set at “0.” “-1” corresponds to the maximum of the B-3/C-3 tone control, “-5,” the middle, “-9,” the minimum. The tone control found on the B-3/C-3, was only available at “minus” settings, but here you are able to “plus” the settings as well.

**NOTE:** The sound may distort if gains are raised too high. Adjust accordingly.

**NOTE:** This Parameter does NOT affect the PIPE Organ Stops.

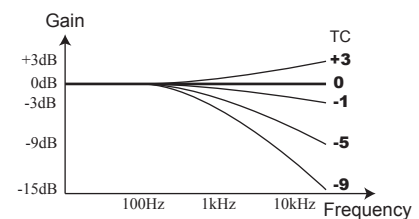
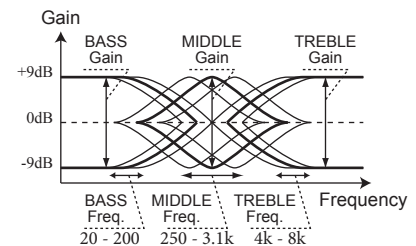

**NOTE:** The Parameters described on this page are Patch Parameters, and can be Recorded to a Patch. For a complete list of all Patch Parameters, please see the APPENDIX starting on page 184.

# MASTER EQUALIZER

**SHORTCUT:** Press and Hold the [MASTER EQ] button.

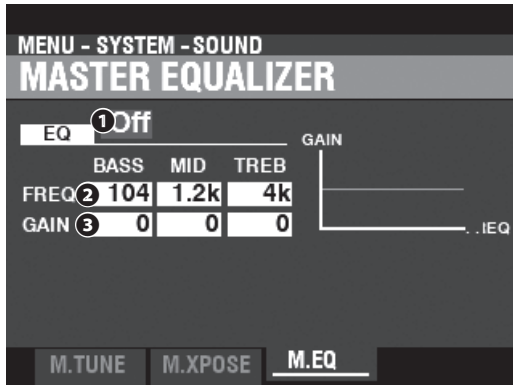

This Page allows you to adjust the overall tonal quality of the instrument.

## 1 EQ ON/OFF

This allows you to turn the Master Equalizer “ON” or “OFF”

**NOTE:** This Parameter is linked to the [MASTER EQ] button on the Control Panel.

## 2 FREQUENCY

**Setting Range:** 20 ~ 308 [Hz] (BASS)

250 ~ 3.1k [Hz] (MID)

3k ~ 8k [Hz] (TREB)

These allow you to adjust the center or “turnover” frequency to be attenuated for BASS, MID and TREBLE respectively.

## 3 GAIN

**Setting Range:** -9 ~ ±0 ~ +9 [dB]

These allow you to adjust the Boost/Cut of BASS, MID and TREBLE respectively.

**NOTE:** At “0” the frequency response is “flat.”

**NOTE:** The Master Equalizer is among the System Parameters. You must Record these Parameters if you want their settings to be remembered the next time the instrument is turned “ON.” See page 141 for instructions on how to do this.

# RECORDING A COMBINATION OR PATCH

After you have made changes to a Combination or Patch, you will most likely want to Record them for future use. To do this, follow the instructions on this page.

## ① PRESS THE RED [RECORD] BUTTON

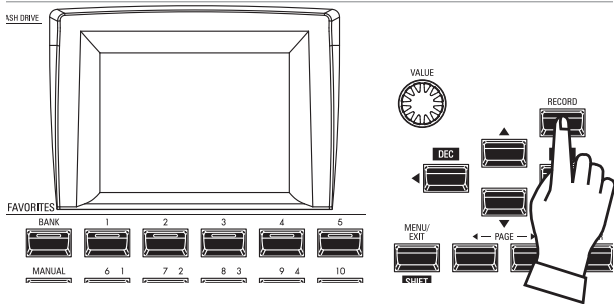

After you have made your changes to a Combination or Patch, press the red [RECORD] button. The RECORD Page will display.

## ② SELECT THE ITEM TO RECORD

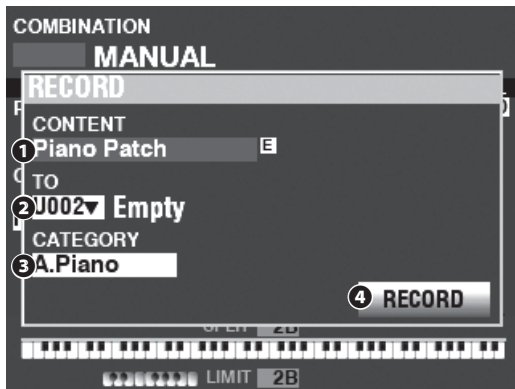

### ① CONTENT

Use the [VALUE] knob to select the Bundle, Combination or Patch you wish to Record. The choices are shown below.

- Bundle
- Combination Patch
- Organ Patch
- Piano Patch
- Ensemble Patch
- Synth Patch

**NOTE:** A **Bundle** allows you to Record COMBINATION, ORGAN and MONO SYNTH Parameters in one group so that Patches can be created in fewer steps. See page 26 for more information about Bundles.

### ② TO

Use the [DIRECTION] [▼] button to move the cursor to "TO."

Use the [VALUE] knob to select the User Number to Record.

### ③ CATEGORY

If the Patch to be Recorded is a PIANO or ENSEMBLE Patch, use the [DIRECTION] [▼] button to move the cursor to "CATEGORY" and use the [VALUE] knob to select the Category.

## ④ RECORD

After you have done Steps 1 through 3 above, use the [DIRECTION] [▼] button to move the cursor to the [RECORD] icon and press the [ENTER] button. The Naming screen will display.

## ③ NAME THE ITEM

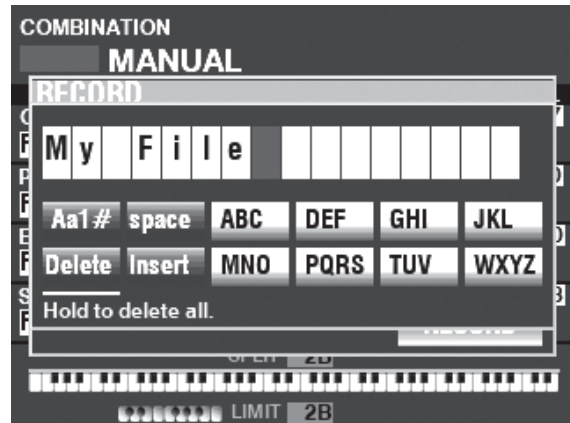

Enter the Name.

- [Aa1]..... Changes the character type.
- [1] - [10] ..... Selects the highlighted character.
- [Insert] ..... Inserts a space at the cursor.
- [Delete] ..... Deletes a letter at the cursor.
- [VALUE]..... Changes the letter at the cursor.

After you are finished Naming, press the [ENTER] button. The message shown below will display for approximately 1 second:

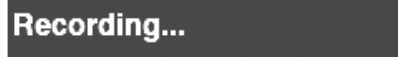

**NOTE:** Do not turn the power "OFF" while the above message is displaying.

**NOTE:** If you DO NOT wish to Record, press the [MENU/EXIT] button instead of the [ENTER] button.

## ④ RETURN TO THE PLAY MODE

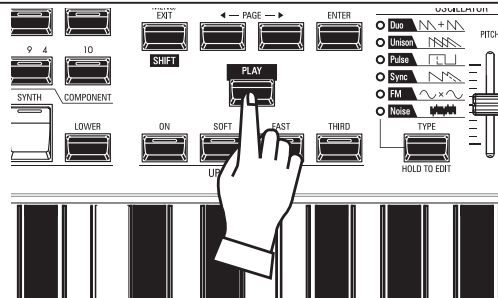

Press the [PLAY] button to return to the PLAY mode.

The SK PRO allows you to Record certain Parameters into macro-settings called **Custom Tone Wheels**, **Custom Pipes**, **Custom Pedal Registrations** and **Custom Leslie Cabinets**. In this way you can include multiple Parameter settings as part of a Combination, Patch or Bundle, and include the same settings in multiple Patches.

## TO LOCATE THE CUSTOM EDIT MENU:

[MENU/EXIT] - PAGE [▶]

Use the [DIRECTION] [▼]/[▲] buttons to select the CUSTOM EDIT Page you want.

## CUSTOM CONTENTS

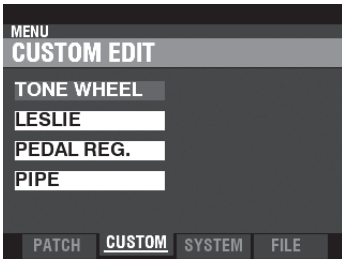

### CUSTOM TONE WHEEL (P. 120)

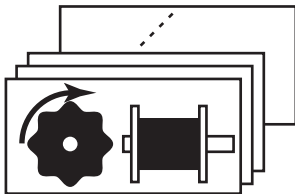

This allows you to select or create Custom Tone Wheels. A Custom Tone Wheel includes profiles of specific organs, Drawbar Foldback points, levels of each individual Tone Wheel, etc.

### CUSTOM LESLIE (P. 124)

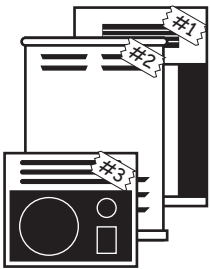

This allows you to select or create Custom Leslie Cabinets.

**NOTE: None of the Custom Parameter settings will be remembered unless they are Recorded in one of the Custom units.**

### CUSTOM PEDAL REGISTRATION (P. 123)

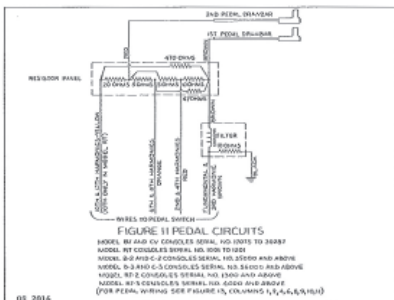

This allows you to select and create Custom Pedal Registrations (registrations for the Pedal Drawbars).

### CUSTOM PIPE (P. 126)

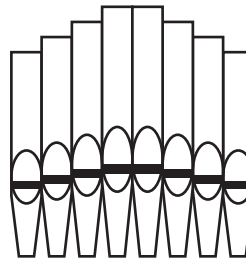

This allows you to select or create Custom Pipes. A Custom Pipe includes assignment of Pipe Voices to the Drawbars as well as Volume settings, Chiff settings, etc.

If you select an ORGAN Type other than the one currently selected, a dialog box similar to the one shown below will display.

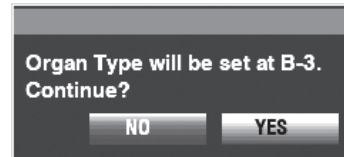

If you want to change the ORGAN Type, use the [DIRECTION] [▶] button to move the cursor to the [YES] icon, and press the [ENTER] button. If you select [NO] the previous screen will appear.

## APP (APPLICATION) MENU

The APP (Application) Menu allows you to select various Menu Pages quickly. To display the APP Menu:

1. Select one of the Custom Settings to edit.
2. Press and Release the [≡] button. The Menu option shown below will display:

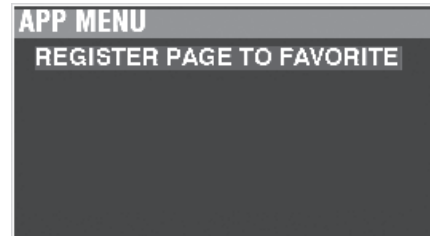

**REGISTER PAGE TO FAV** .....Registers the currently selected Page to the Favorites.

Press the [ENTER] button to select the displayed option.

# CUSTOM TONE WHEELS

This FUNCTION Mode you allows you select or edit the characteristics of the Tone Wheel Organ.

The Parameters described on these pages are grouped in macro-settings called **Custom Tone Wheels**. These Parameters cannot be Recorded as individual Patch Parameters; however, a Custom Tone Wheel can be Recorded as part of an ORGAN Patch.

## TO LOCATE THIS MODE:

[MENU/EXIT] - **CUSTOM - TONE WHEELS** - [ENTER]

### SET

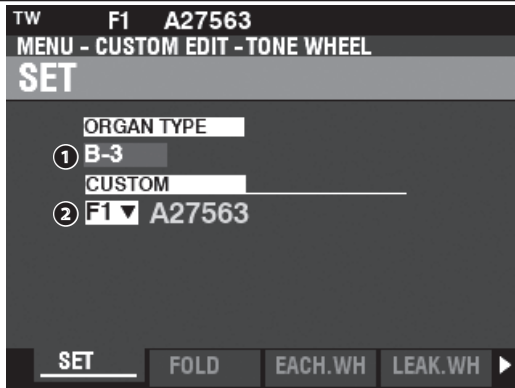

#### 1 ORGAN TYPE (P)

**Setting Range:** A-100, B-3, C-3, Mellow

This allows you to select the ORGAN Type to edit.

#### 2 CUSTOM SET (P)

**Setting Range:** F1 ~ F3, U1 ~ U3

This allows you to select the Custom Number to edit. “F” refers to Factory settings which are permanently stored in memory and cannot be overwritten. “U” or User settings can be modified or even overwritten entirely in order to create your own Custom Tone Wheels.

### FOLD BACK

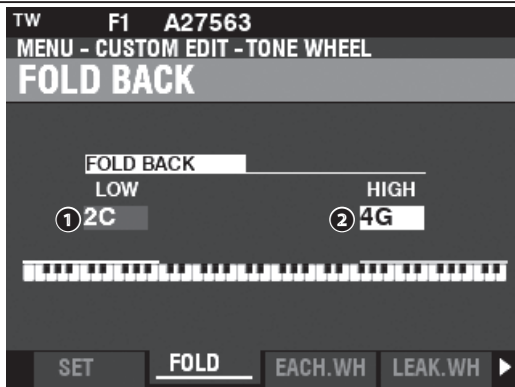

#### 1 LOW (TW)

**Setting Range:** 1C ~ 2C

This allows you to adjust the key-point from which the Drawbar pitches for the Sub-Fundamental (16') Drawbar “Fold Back” (repeat the pitches played by other notes) on the lower octave of the keyboard.

The bottom key on the keyboard is displayed as “1C.”

#### 2 HIGH (TW)

**Setting Range:** 4G ~ 5C

This allows you to adjust the key-point at which the Drawbar pitches “Fold Back” (repeat the pitches played by other notes) in the higher octaves of the keyboard.

**NOTE:** The FOLD BACK effect will be heard starting with the 2 $\frac{2}{3}$ ' Drawbar (first black Drawbar) and all the other Drawbars which introduce high harmonics.

### tips

#### WHAT ARE “CUSTOM TONE WHEELS?”

When the tone-wheel Hammonds - B-models, C-models, A-100, etc. - were being manufactured, each individual organ was subjected to a rigorous series of checks and tests to insure the quality of each unit, and to insure that all the units representing a particular model series all sounded alike. However, since the very newest B-3-type organ is at least 45 years old, vintage organs are dependent for their sound on analog components. Several factors may affect the sound of a particular unit. Thus, a B-3 manufactured in 1959 may well have a slightly different tone than one made in 1969, not necessarily because of the year but because of slight differences in component values among other factors. Also, many characteristics of the Hammond Organ, especially as heard in much jazz and rock music, have to do with the overall condition of the instrument. The Custom Tone Wheel feature is included to allow you to find, or create the nearest approximation of what you want your “Hammond Sound” to be.

All of the Parameters described on this page and on the following pages comprise a Custom Tone Wheel. These Parameters cannot be Recorded as individual Patch Parameters; however, a Custom Tone Wheel can be Recorded as part of an ORGAN Patch.

### tips

#### FOLD BACK

On the earliest model Hammond Organs, the Sub-Fundamental Drawbar (the one marked, “16”) would continue to play all the way down to the lowest “C” (“1C”). Newer models such as the Hammond Models X-66, X-77 and Concorde do the same, however, the 8th harmonic Drawbar (the one marked “1”) continues to play up the keyboard to the next to highest “C” (“5C”) on the Keyboard.

On a vintage B-3, C-3, A-100, etc., the lowest note produced by the Sub-Fundamental Drawbar is the 2nd “C” (“2C”) from the left end of the Keyboard, while the highest note that can be played by the 8th harmonic Drawbar is the 4th “F#” from the left end of the Keyboard. The lower and higher keys on the keyboard **Fold Back**, in that they repeat the pitches played by other notes.



## EDITING EACH TONE WHEEL

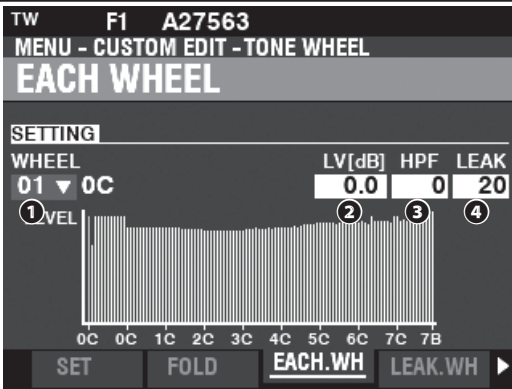

### 1 WHEEL

This allows you to select the Tone Wheel you want to edit.

The setting range is displayed by “wheel# : note” style,

- 01: 0C to 12: 0B,
- F01: 0C to F12: 0B,
- 13: 1C to 91: 7F# and
- F92: 7G to F96: 7B.

“F” means the wheel used for extended “Fold Back.” The non-marked Wheel Numbers indicate original wheels from the B-3/C-3/A-100.

There are two ways to select the Wheel Number:

1. Use the [VALUE] knob, or,
2. If you want to locate a certain Tone Wheel quickly, move the Drawbar slightly while depressing the key you want to regulate (see the illustration on the right).

When the Wheel Number is selected, each Parameter for the wheel (2 to 4) is updated.

**NOTE:** Make sure [TRANPOSE] and [OCTAVE] are set at “0” to ensure that the correct Wheel is selected.

### 2 LEVEL (TW)

**Setting Range:** -Inf, -92.0 ~ +4.0 [dB]

This allows you to adjust the volume of the selected Wheel.

### 3 HPF (TW)

**Setting Range:** 0 ~ 127

This allows you to adjust the “HPF” (**High-Pass Filter**), which will remove the higher frequencies of the selected Wheel.

A lower value will introduce a “motor hum” or noise) which will be heard in addition to the Tone Wheel sound.

### 4 LEAK (TW)

**Setting Range:** 0 ~ 127

This allows you to adjust the amount of Leakage sound added to the Fundamental sound.

A higher value will result in more Leakage.

**NOTE:** See page 122 for more information about Leakage.

### tips “F” WHEELS AND PEDAL WHEELS

On the B-3/C-3/A-100, there are 91 sounding tone wheels. Wheels #1 through #12 are special wheels called **Complex Wheels** used exclusively for the Pedal tones. Later Hammond models had 96 sounding tone wheels, with the Sub-Fundamental Drawbar (the one marked, “16”) continuing to play all the way down to the lowest “C” (“1C”) and 5 additional pitches at the top. On the SK PRO, the extended pitches are designated as “F” (Fold Back) pitches (see the illustration below).

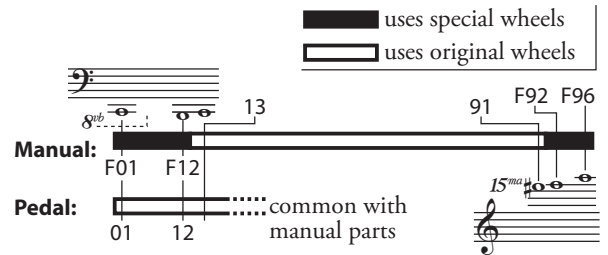

### tips DECIBEL (dB)

A decibel (dB) is a unit for measuring the intensity of a sound. For example, “0dB” is a reference level, “+6dB” doubles the sound intensity and “-6db” decreases the sound intensity by about 50%.

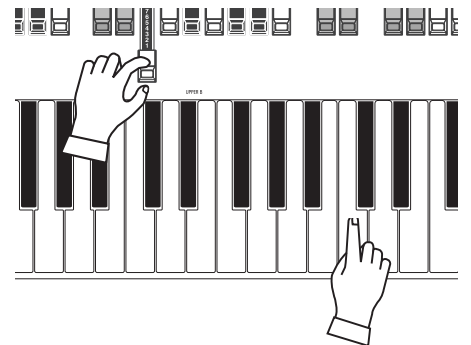

Selecting a WHEEL NUMBER to edit

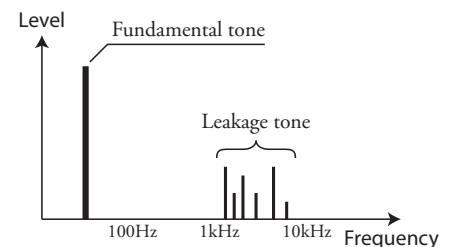

Leakage Tone

**NOTE:** The Parameters labeled (TW) are Tone Wheel Parameters. You must Record these Parameters to a Custom Tone Wheel if you want their settings to be remembered the next time the instrument is turned “ON.” See page 128 for instructions on how to do this.

**LEAKAGE WHEEL**

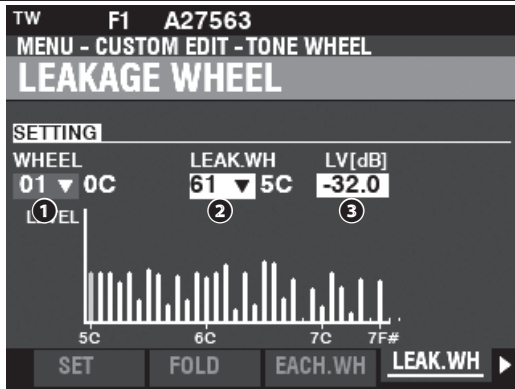

**2 LEAK WH (TW)**

This allows you to add a Leakage Tone to any of the Wheels from “01:0C” to “72:6B” (“Fundamental Wheels”) by using the “Leakage Wheels” (“61:6C” through “91:8F” - see the illustration on the right).

The Leakage Wheel will sound along with the Fundamental Wheel **1**.

There are two ways to select a Leakage Wheel:

**3 LEVEL (TW)**

**Setting Range:** -Inf (OFF), -92.0 ~ +4.0 [dB]

This allows you to adjust the Volume of the selected Leakage Wheel.

**NOTE:** The overall volume of the selected Wheel may decrease as the Leakage Volume is increased.

**tips WHAT IS “LEAKAGE?”**

On a tone-wheel Hammond Organ, each tone wheel rotates next to a magnet, making a total of 91 or 96 magnets. The tone wheels are mounted in separate bins to isolate them from each other and prevent the magnets from intercepting frequencies from neighboring wheels; however, a small amount of current may still “leak” through, producing a phenomenon called Leakage. Leakage is usually heard as a “hash” type sound consisting of many frequencies sounding at once. The phenomenon can be thought of as similar to white noise but with somewhat more definition, with individual pitches more discernable. A properly calibrated B-3 will have a minimum of this effect; however, an instrument which has been subjected to hard use over a period of time may exhibit more leakage noise.

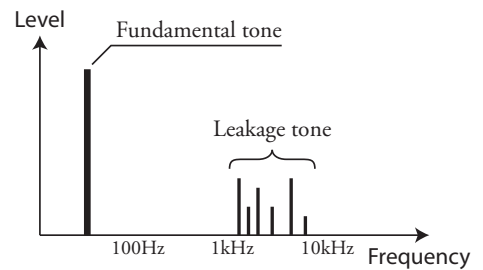

**MATRIX LEVEL**

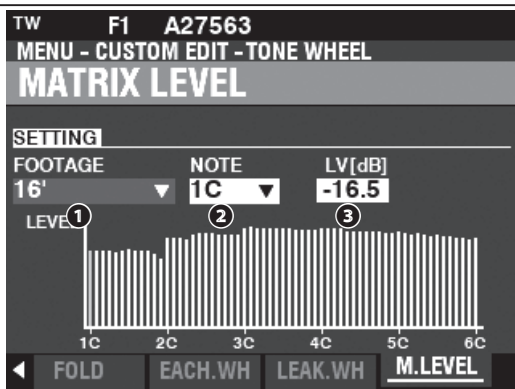

**1 FOOTAGE (TW)**

**Setting Range:** 16, 5-1/3, 8, 4, 2-2/3, 2, 1-3/5, 1-1/3, 1, Perc 2nd, Perc 3rd

**2 NOTE (TW)**

**Setting Range:** 1C ~ 6C

This allows you to select Matrix to adjust the level of each Drawbar and each note.

**3 LEVEL (TW)**

**Setting Range:** -Inf, -92.0 ~ +4.0 [dB]

This allows you to adjust the level of the Matrix selected above.

**NOTE:** The Parameters labeled (TW) are Tone Wheel Parameters. You must Record these Parameters to a Custom Tone Wheel if you want their settings to be remembered the next time the instrument is turned “ON.” See page 128 for instructions on how to do this.

This FUNCTION Mode allows you to select or edit the registrations for the PEDAL or Sub-Drawbars.

The Parameters described on this page are grouped in macro-settings called Custom Pedal Registrations. These Parameters cannot be Recorded as individual Patch Parameters; however, a Custom Pedal Registration (PEDAL REG.) can be Recorded as part of an ORGAN Patch.

## TO LOCATE THIS MODE:

[MENU/EXIT] - **CUSTOM - PEDAL REG.** - [ENTER]

The Tone Wheel Organs A-100, B-3, C-3 and Mellow contain the “Sub-Drawbar” registrations. If these ORGAN Types are selected, the Sub-Drawbars will be selected.

## tips WHAT ARE “SUB-DRAWBARS?”

On a tone-wheel Hammond Organ, the harmonic resources for Pedal tones are combined into two Drawbars each of which draws a combination of harmonics instead of individual harmonics as with the other Drawbars. Over the years, several different schemes were used to voice the Pedal Drawbars. These are shown below.

## SET



### 1 CUSTOM SET

**Setting Range:** F1 ~ F3, U1 ~ U3

This allows you to select the Custom Number to edit.

“F” refers to Factory settings which are permanently stored in memory and cannot be overwritten. “U” or User settings can be modified or even overwritten entirely in order to create your own Custom Pedal Registration.

## EACH PEDAL DRAWBAR

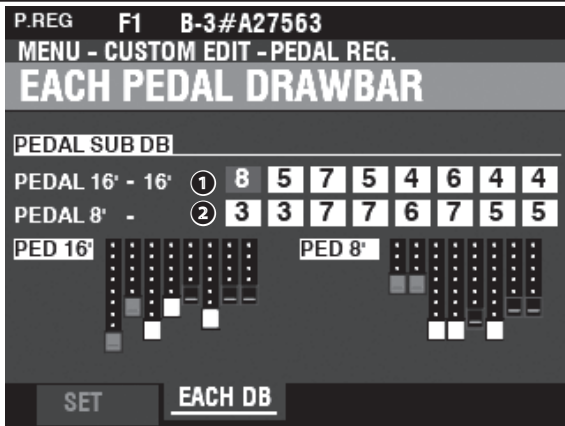

### 1 SUB DRAWBAR - 16' (PR)

### 2 SUB DRAWBAR - 8' (PR)

**Setting Range:** 0 ~ 8

These allow you to adjust the harmonics of each Pedal Drawbar. Adjustable footages are 16', 5 1/3', 8', 4', 2 2/3', 2', 1 3/5', and 1 1/3'.

**NOTE:** The footages 2 2/3', 2', 1 3/5' and 1 1/3' in the Sub Drawbar 16' have softer maximum volumes than the other footages for fine-adjustment.

**NOTE:** The Parameter labelled (PR) are Pedal Registration Parameters. You must Record these Parameters to a Custom Pedal Registration if you want their settings to be remembered the next time the instrument is turned “ON.” See page 128 for instructions on how to do this.

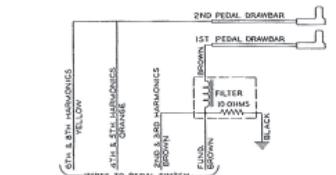

FIGURE 8 PEDAL CIRCUITS  
MODEL A CONSOLES SERIAL NO. 1 TO 2499  
MODEL B AND BC CONSOLES SERIAL NO. 4000 TO 5075  
(FOR PEDAL WIRING SEE FIGURE 13, COLUMNS 1,4,5,6,7,8,9)

OS 2013

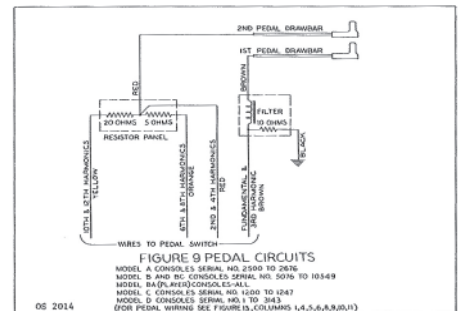

FIGURE 9 PEDAL CIRCUITS  
MODEL A CONSOLES SERIAL NO. 2500 TO 2626  
MODEL B AND BC CONSOLES SERIAL NO. 5076 TO 10349  
MODEL BA (FILTER) CONSOLES-ALL  
MODEL C CONSOLES SERIAL NO. 1000 TO 1247  
MODEL D CONSOLES SERIAL NO. 1 TO 343  
(FOR PEDAL WIRING SEE FIGURE 13, COLUMNS 1,4,5,6,8,9,10,11)

OS 2014

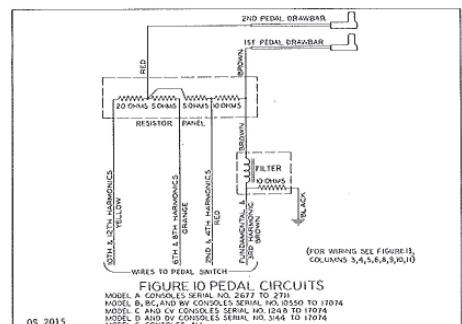

FIGURE 10 PEDAL CIRCUITS  
MODEL A CONSOLE SERIAL NO. 2627 TO 2718  
MODEL B, BC, AND BV CONSOLES SERIAL NO. 10350 TO 12074  
MODEL C AND CV CONSOLES SERIAL NO. 1248 TO 12074  
MODEL D AND DV CONSOLES SERIAL NO. 344 TO 12074  
MODEL E CONSOLE-ALL

OS 2015

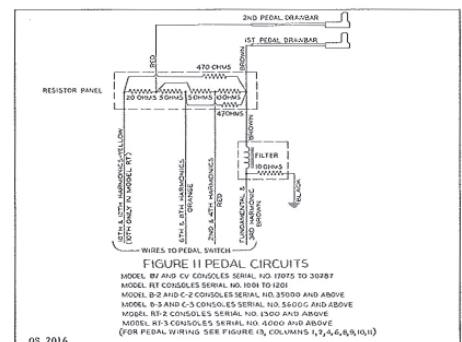

FIGURE 11 PEDAL CIRCUITS  
MODEL BY AND BV CONSOLES SERIAL NO. 12075 TO 20287  
MODEL RE CONSOLES SERIAL NO. 1028 TO 1201  
MODEL B-2 AND C-2 CONSOLES SERIAL NO. 35000 AND ABOVE  
MODEL B-3 AND C-3 CONSOLES SERIAL NO. 35001 AND ABOVE  
MODEL RT-2 CONSOLES SERIAL NO. 13000 AND ABOVE  
MODEL RT-3 CONSOLES SERIAL NO. 40000 AND ABOVE  
(FOR PEDAL WIRING SEE FIGURE 13, COLUMNS 1,3,4,6,8,9,10,11)

OS 2016

# CUSTOM LESLIE

This FUNCTION Mode allows you to select or edit the Parameters for the inbuilt digital Leslie.

The Parameters described on these pages are grouped in macro-settings called **Custom Leslie Cabinets**. These Parameters cannot be Recorded as individual Patch Parameters; however, a Custom Leslie Cabinet can be Recorded as part of an ORGAN Patch.

## TO LOCATE THIS MODE:

[MENU/EXIT] - CUSTOM - LESLIE - [ENTER]

### CABINET NUMBER



#### 1 CUSTOM CABINET

Setting Range: F1 ~ F8

This allows you to select the Cabinet Number to edit.

“F” refers to Factory settings which are permanently stored in memory and cannot be overwritten. “U” or User settings can be modified or even overwritten entirely in order to create your own Custom Leslie Cabinets.

### SPEAKER

#### 1 SPEAKER (L)

Settings: L145 Front, L145 Rear, L147 Front, L147 Rear, L122 Front, L122 Rear, Cone Type, PR-40 Type

This allows you to select the Custom Leslie Cabinet.

NOTE: See the APPENDIX on page 191 for more information about Custom Leslie Cabinets.

### ROTOR

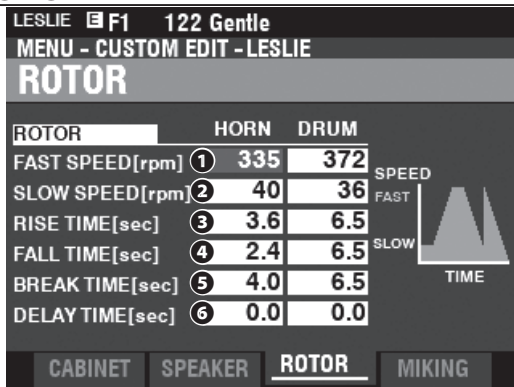

#### 1 SLOW SPEED - HORN / DRUM (L)

Setting Range: 0, 20 ~ 120 [rpm]

These allow you to set the rotor speed for the “SLOW” or Chorale Mode.

#### tips WHAT ARE “CUSTOM LESLIE CABINETS?”

All of the Parameters described on this page and on the following page comprise a Custom Leslie Cabinet. These Parameters cannot be Recorded as individual Patch Parameters; however, a Custom Cabinet can be Recorded as part of a Patch.

The SK PRO has 8 different Custom Leslie Cabinets. These are Factory Cabinets (indicated by an “F”) which are permanently written in memory. However, you can create and Record up to 8 User Cabinets (which will be indicated by a “U.”

To create and Record a Leslie Cabinet, use the LESLIE FUNCTION Mode to modify the sonic characteristics of one of the “F” Cabinets. After you have made all of your changes, you can Record them as a “U” Leslie Cabinet.

For a list of the Factory Leslie Cabinets consult the APPENDIX at the back of this Manual starting on page 191. For a complete list of Leslie Parameters consult the APPENDIX on page 193.

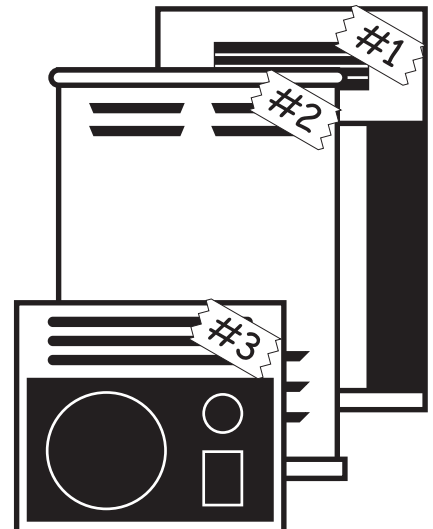

**2 FAST SPEED - HORN / DRUM (L)**

**Setting Range:** 0, 200 ~ 500 [rpm]

These allow you to set the rotor speed for the “FAST” or Tremolo Mode.

**3 RISE TIME - HORN / DRUM (L)**

**Setting Range:** 0.8 ~ 12.5 [sec] (Horn)  
1.0 ~ 12.5 [sec] (Drum)

These allow you to adjust the time for the rotors to “ramp up” to “FAST” Mode when switching from ‘SLOW’ or ‘STOP’ to ‘FAST’ Mode.

**4 FALL TIME - HORN / DRUM (L)**

**Setting Range:** 0.8 ~ 12.5 [sec] (Horn)  
1.0 ~ 12.5 [sec] (Drum)

These allows you to adjust the time for the rotor to reach the ‘SLOW’ rotor speed when switching from “FAST” to “SLOW” Mode.

**5 BRAKE TIME - HORN / DRUM (L)**

**Setting Range:** 0.8 ~ 12.5 [sec] (Horn)  
1.0 ~ 12.5 [sec] (Drum)

This allows you to adjust the time for the rotor to Stop when switching from “FAST” to “SLOW” Mode.

**6 DELAY TIME - HORN / DRUM (L)**

**Setting Range:** 0.0 ~ 1.0 [sec]

These allow you to adjust the time to start changing the speed, when the Mode is switched.

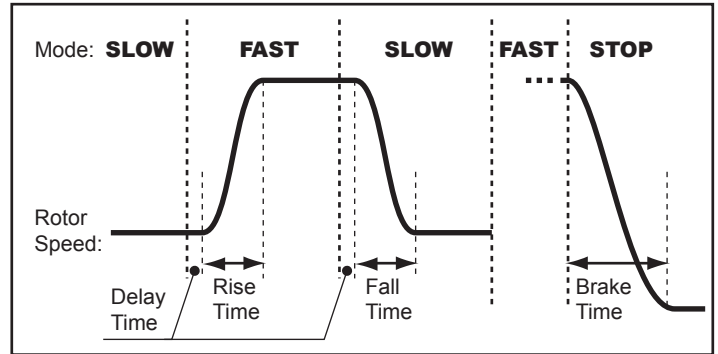

**tips SETTING SLOW AND FAST SPEEDS**

The Leslie Fast and Slow Speed settings are widely variable. However, it is recommended to set the Leslie Speeds at ranges of between 40 and 400 (rpm). This will result in the most pleasing overall sound for most applications.

**MICROPHONE SETTINGS**

These Parameters allow you to replicate various Microphone placements of a Leslie Speaker Cabinet.

**1 LEVEL - HORN / DRUM / SUB BASS (L)**

**Setting Range:** -INF, -76 ~ 0 [dB]

These allow you to adjust the volume levels of the Horn Rotor, Drum Rotor and Sub Bass

**NOTE: The Sub Bass sound is “dry” - not modulated.**

**2 WIDTH - HORN / DRUM (L)**

**Setting Range:** 0 ~ 40 [cm]

These allow you to adjust the distance between Left and Right Microphones. At “0” there is no separation.

A higher value will increase the stereo separation.

**3 CENTER - HORN / DRUM (L)**

**Setting Range:** -50 ~ +50 [cm]

This allows you to adjust the offset between the center of two microphones and the pivot of the rotor.

On a Leslie Speaker Cabinet the Horn Rotor rotates counter-clockwise and the Drum Rotor rotates clockwise. The digital Leslie replicates this feature. To emphasize the ‘upcoming’, set a ‘+’ value for the Horn rotor, and a ‘-’ value for the Drum rotor.

**4 DISTANCE - HORN / DRUM (L)**

**Setting Range:** 30 ~ 200 [cm]

These are for replicating distance settings between a Leslie Speaker and the microphones. A lower value results in a deeper effect.

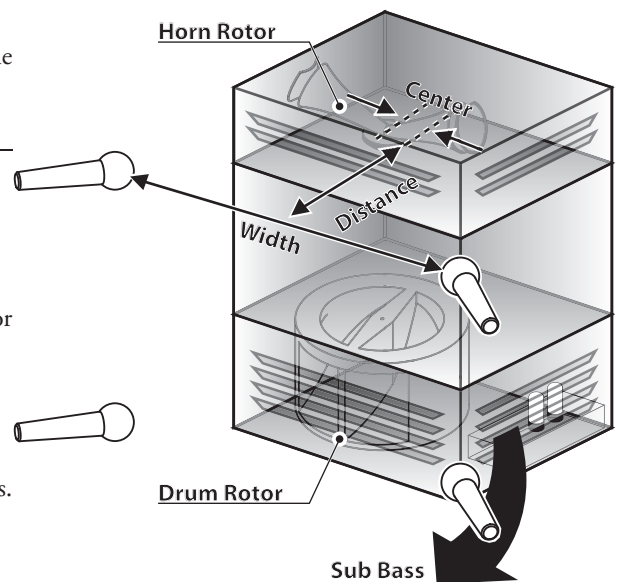

**NOTE: The Parameters labeled “L” are Leslie Parameters. You must Record these Parameters to a Custom Leslie Cabinet if you want their settings to be remembered the next time the instrument is turned “ON.” See page 128 for instructions on how to do this.**

# CUSTOM PIPE

This FUNCTION Mode allows you to select or edit the characteristics of the Pipe Voices.

The Parameters described on these pages are grouped in macro-settings called **Custom PIPES**. These Parameters cannot be Recorded as individual Patch Parameters; however, a Custom Pipe can be Recorded as part of an ORGAN Patch.

## TO LOCATE THIS MODE:

[MENU/EXIT] - **CUSTOM - PIPE** - [ENTER]

## SET

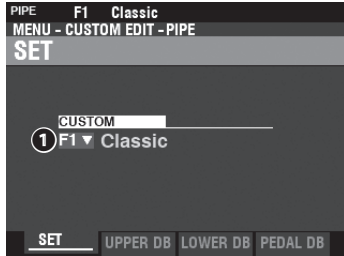

### 1 CUSTOM SET

**Setting Range:** F1 ~ F3, U1 ~ U3

This allows you to select the Custom Pipe Number to edit.

The letter “F” means factory (not re-writable) and “U” means user (re-writable).

## UPPER / LOWER / PEDAL STOP SET

This allows you to assign Pipe Voices to the Drawbars and to adjust the Parameters of each Stop to your preference. Each Parameter is explained in detail starting below.

PIPE	F1	Classic	Classic									
MENU - CUSTOM EDIT - PIPE			CUSTOM EDIT - PIPE									
UPPER STOP SET				STOP SET								
	1	2	3	4	5	6	7	8	9			
	STOP	VOL[dB]	FTG	TUNE	TREM	CHIFF	C.OFF	PAN	IMAGE			
UPPER 1	S04▼	-4.5	16'	0	On	Soft	-25	L16	16	LtoR		
UPPER 2	S01▼	-2.5	8'	0	On	Loud	-28	L24	24	LtoR		
UPPER 3	S06▼	-1.5	8'	0	On	Loud	0	L20	20	LtoR		
UPPER 4	S10▼	-5.5	8'	0	On	Soft	-35	L12	12	LtoR		
UPPER 5	S02▼	-8.0	4'	0	On	Loud	-23	L8	8	LtoR		
UPPER 6	S05▼	-9.5	4'	0	On	Loud	-23	L10	10	LtoR		
UPPER 1 S04 : [Classic] Bourdon 1				: [Classic] Bourdon 1								
	SET	UPPER DB	LOWER DB	PEDAL DB	UPPER DB	LOWER DB	PEDAL DB	PEDAL DB				

### 1 STOP (Pi)

This allows you to assign a Pipe Stop to each of the Drawbars.

**NOTE:** See page 177 for a list of the available Pipe Stops.

### 2 VOLUME (Pi)

**Setting Range:** -Inf, -92.0 ~ +4.0 [dB]

This allows you to adjust the Volume of each Pipe Stop.

### 3 FOOTAGE (Pi)

**Setting Range:** 32, 16, 5 1/3, 8, 4, 2 2/3, 2, 1 3/5, 1 1/3, 1

This allows you to adjust the Pitch of each Pipe Stop. The pitches are expressed in Footages.

**NOTE:** See page 38 for more information about Drawbars and their Footage designations.

### 4 TUNE (Pi)

**Setting Range:** -50 ~ ±0 ~ +50 [cent]

This allows you to detune the pitch of the selected Pipe Voice Up or Down by cents (50 cents = one quarter-step).

### 5 TREMULANT (Pi)

**Settings:** Off, On

This allows you to add Tremulant to the Pipe Voices using the [VIBRATO] controls.

## tips

### WHAT ARE “CUSTOM PIPES?”

All of the Parameters described on this page and on the following page comprise a Custom Pipe. These Parameters cannot be Recorded as individual Patch Parameters; however, a Custom Pipe can be Recorded as part of a Patch.

The SK PRO has 3 different Factory Custom Pipes, indicated by an “F,” which are permanently written in memory. You can create and Record up to 3 User Custom Pipes which will be indicated by a “U.”

To create and Record a Custom Pipe, use the PIPE FUNCTION Mode to edit the Parameters of one of the “F” Custom Pipes. After you have made all of your changes, you can Save them as a “U” Custom Pipe.

## tips

### TREMULANT

Pipe organs typically have one or more “tremulants” which vary the air pressure to the pipes periodically, producing a vibrato or tremolo effect.

**6 CHIFF (Pi)**

**Settings: Off, Soft, Mid, Loud**

This allows you to adjust the amount of Chiff or attack for the selected Pipe Voice.

**Off** .....No Chiff.

**Soft** .....A small amount of chiff.

**Mid** .....A moderate amount of chiff.

**Loud** .....The maximum amount of chiff.

**NOTE: Reed stops such as "Hautbois," "Trompette" and "Cornoepen" do not receive Chiff.**

**7 CUTOFF (Pi)**

**Setting Range: -127 ~ 0**

This allows you to adjust the Cutoff Frequency (brightness).

**8 PAN (Pi)**

**Setting Range: L64 ~ C ~ R63**

This allows you to adjust the basic direction of the pipe.

**9 IMAGE (Pi)**

This allows you to adjust the arrangement of the pipe.

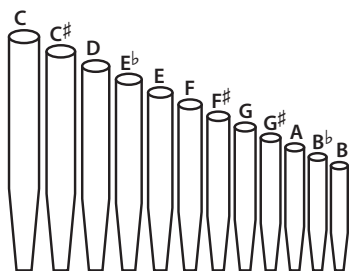
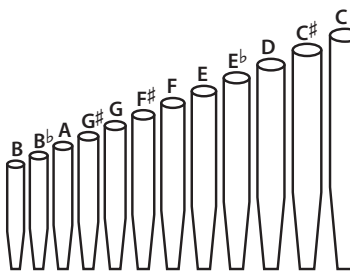
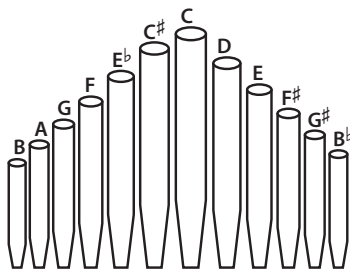
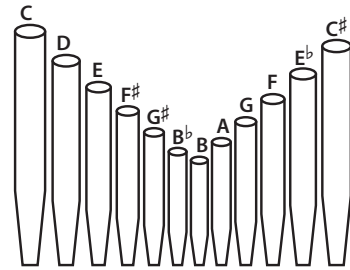
FIX	No image	No imaging - all the notes sound from the center).
L-R		Pipes producing lower pitches are on the left. Playing notes chromatically going up on the keyboard will cause the pipes on the left to sound first
R-L		Pipes producing higher pitches are on the right. Playing notes chromatically going up on the keyboard will cause the pipes on the right to sound first
PYR		When notes are played chromatically going from left to right on the keyboard, the notes start in the center and alternate between left and right
INV		When notes are played chromatically going up on the keyboard, the notes start at one end and alternate between left and right until they meet in the center.

**tips WHAT IS "CHIFF?"**

On a pipe organ, when a flue stop such as a Diapason, String or Flute is drawn and a key is depressed, a valve opens, and air escapes through the hole in which the pipe sits, allowing the pipe to sound. When the air first enters the pipe, there is a small, short burst of upper harmonics before the tone develops fully. The term "Chiff" was coined by pipe organ makers to describe this sound.

**tips WHAT IS "PIPE VOICE IMAGING?"**

The pipes of a pipe organ are arranged into sets called ranks. Each rank consists of pipes representing a specific sound on the organ - Open Diapason, Trompette, etc. (In keeping with the different philosophies of organ sound, many organ stop names are of European origin; hence the use of French, German, Dutch, etc.)

The pipes of each rank are supported by an assembly called a chest. The pipes can be arranged in many different ways on the chest. The pipe arrangement chosen by the maker depends on several things - aesthetics, musical, etc. - but the four most common ones are shown on the left.

The two pipe placement schemes on the immediate left are sometimes referred to as "C-C#" placement due to chromatic notes being separated.

**NOTE: The Parameters labeled (Pi) are Pipe Parameters. You must Record these Parameters to a Custom Pipe if you want their settings to be remembered the next time the instrument is turned "ON." See page 128 for instructions on how to do this.**

# RECORDING A CUSTOM SETTING

To Record a Custom Setting, do the following:

## ① PRESS THE RED [RECORD] BUTTON

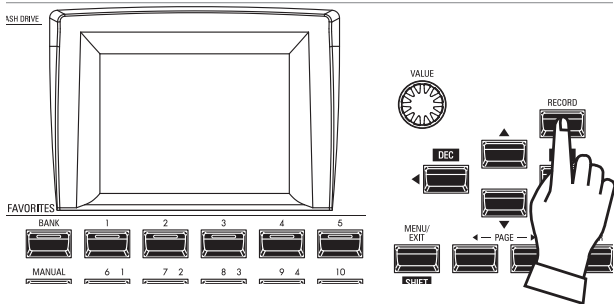

After you have made your changes to a Custom Setting, press the red [RECORD] button. The RECORD Page will display.

## ② SELECT THE ITEM TO RECORD



### ① TO

Use the [VALUE] knob to select the User Number to Record.

**NOTE:** You can also select a User Number by using the numbered [FAVORITE] buttons to type in the number and pressing the [ENTER] button.

**NOTE:** If edits have been made to a Custom Setting, an "E" will appear to the right of the CONTENT icon.

**NOTE:** You CANNOT Record to an "F" setting.

### ② RECORD

After you have selected the User Number, press the red [RECORD] button. The Naming screen will display.

## ③ NAME THE CUSTOM SETTING

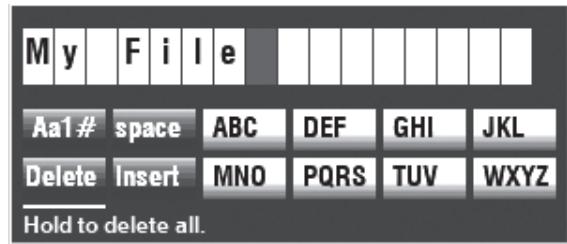

Enter the Name.

[Aa1].....Changes the character type.

[1] - [10] ..... Selects the highlighted character.

[Insert] ..... Inserts a space at the cursor.

[Delete]..... Deletes a letter at the cursor.

[VALUE]..... Changes the letter at the cursor.

## ④ RECORD THE SETTING

After Naming your Custom Setting, press the [ENTER] button. The message shown below will display for approximately 1 second:

**Recording...**

**NOTE:** Do not turn the power "OFF" while the above message is displaying.

**NOTE:** If you DO NOT wish to Record, press the [MENU/EXIT] button instead of the [ENTER] button.

## ⑤ RETURN TO THE PLAY MODE

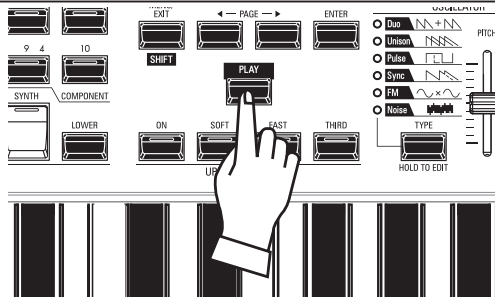

Press the [PLAY] button to return to the PLAY mode.



**System Parameters** allow you to adjust functions such as the Parameters for the AUDIO jacks, the MIDI Ports, various Controllers, loading and saving Patches, etc. A complete list is shown on this page.

## SYSTEM PARAMETERS AND CONTENTS

### SOUND (P. 130)

- ◆ Master Tune
- ◆ Transpose
- ◆ Master Equalizer

### AUDIO (P. 131)

- ◆ [ROTARY OUT] jack
- ◆ [PEDAL OUT] jack
- ◆ [INDIVIDUAL OUT] jacks
- ◆ Audio channels of the Leslie Speaker system

### CONTROL (P. 132)

- ◆ Foot Switch
- ◆ Expression Pedal
- ◆ Damper Pedal
- ◆ [USER] button
- ◆ [PITCH BEND] wheel
- ◆ Tone Wheel Brake
- ◆ Display
- ◆ Action of the knobs and buttons
- ◆ Keyboard

### PATCH LOAD (P. 138)

Parameter range to load when a Combination is selected.

### FAVORITES (P. 139)

- ◆ Action of the Favorites feature
- ◆ Edit the Favorites for Combinations
- ◆ Edit the Favorites for Display pages

### MIDI (P. 156)

- ◆ Purpose of the MIDI Ports
- ◆ Send/Receive a Memory Dump
- ◆ MIDI Channels

### GLOBAL (P. 140)

- ◆ Auto Power Off
- ◆ USB Mass Storage

### DELETE (P. 142)

Delete user content(s)

### DEFAULT (P. 143)

Initialize each content to factory-default settings

### INFORMATION (P. 144)

- ◆ Display Software Versions
- ◆ Update Software

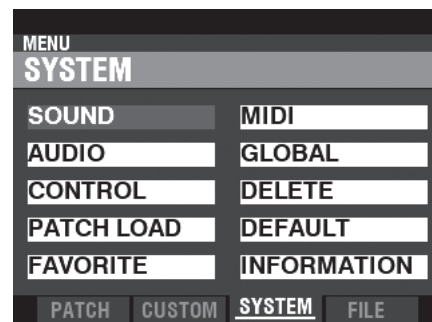

**NOTE:** The Parameters in this Mode are System Parameters. You must Record these Parameters if you want their settings to be remembered the next time the instrument is turned "ON." See page141 for instructions on how to do this.

This FUNCTION Mode allows you to adjust the MASTER TUNE, MASTER TRANSPOSE and MASTER EQUALIZER Parameters which affect the entire instrument.

### TO LOCATE THIS MODE:

[MENU/EXIT] - **SYSTEM** - **SOUND** - [ENTER]

## MASTER TUNE

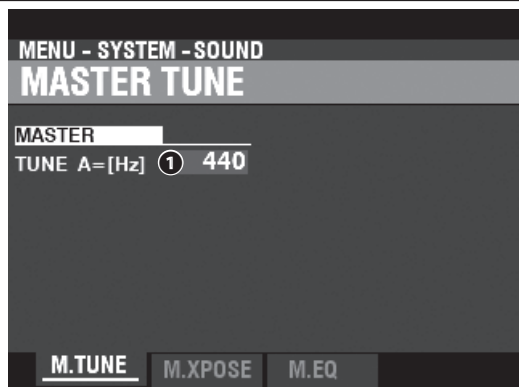

### ① MASTER TUNE

**Setting Range:** A=430 ~ 450 [Hz]

This allows you to adjust the pitch of the entire instrument Up or Down 10 cents (100 cents = one semitone or half-step).

## MASTER TRANSPOSE



### ① MASTER TRANSPOSE

**Setting Range:** -6 ~ ±0 ~ +6 [semitones]

This allows you to Transpose the entire instrument Up or Down 6 semitones.

**NOTE:** This Parameter is linked to the [TRANSPOSE] button on the Control Panel.

**NOTE:** When the power to the SK PRO is turned "OFF," this Transpose setting is not retained. It will be set to "0" when the power is next turned "ON."

## MASTER EQUALIZER

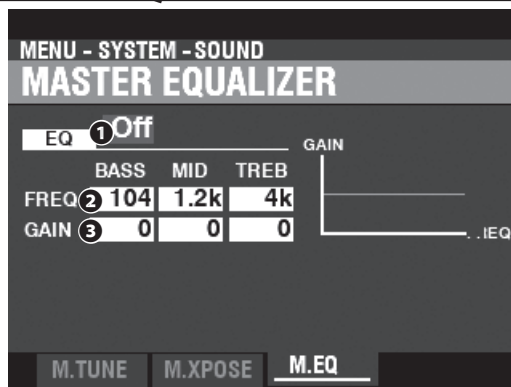

This allows you to adjust the timbre or tone quality of the entire instrument.

### ① SWITCH

**Settings:** Off, On

This allows you to turn the Master Equalizer "ON" or "OFF"

**NOTE:** This Parameter is linked to the [MASTER EQ] button on the Control Panel.

### ② FREQUENCY

**Setting Range:** 20 ~ 308 [Hz] (BASS),  
250 ~ 3.1k [Hz] (MID),  
3k ~ 8k [Hz] (TREB)

These allow you to adjust the center or "turnover" frequency to be attenuated for BASS, MID and TREBLE respectively.

### ③ GAIN

**Setting Range:** -9 ~ ±0 ~ +9 [dB]

These allow you to adjust the Boost/Cut of BASS, MID and TREBLE respectively.

**NOTE:** At "0" the frequency response is "flat."

**NOTE:** The Parameters in this Mode are System Parameters. You must Record these Parameters if you want their settings to be remembered the next time the instrument is turned "ON." See page141 for instructions on how to do this.

This FUNCTION Mode allows you to select how to route the audio signals from the instrument.

## TO LOCATE THIS MODE:

[MENU/EXIT] - **SYSTEM** - **AUDIO** - [ENTER]

### OUTPUT

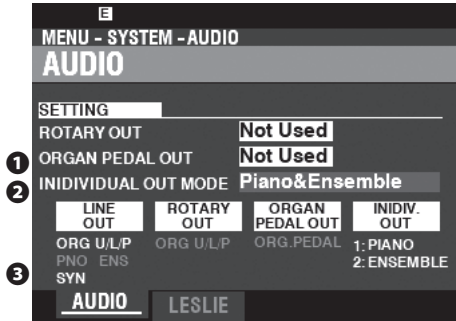

#### 1 ROTARY OUT

**Settings: Not Used, Used**

This allows you to select whether to route an audio signal to the [ROTARY OUT] jack.

**Not Used** ..... The audio from the Tone Wheel and Transistor Organs will be present at the [LINE OUT] jacks.

**Used** ..... The audio from the Tone Wheel and Transistor ORGAN types will be routed to the [ROTARY OUT] jack instead of the [LINE OUT] jacks.

#### 2 PEDAL OUT

**Settings: Not Used, Used**

This allows you to select whether to route an audio signal to the [PEDAL OUT] jack.

**Not Used** ..... The audio from the PEDAL Part of the ORGAN Section will be present at the [LINE OUT] jacks.

**Used** ..... The audio from the PEDAL Part of the ORGAN Section will be routed to the [PEDAL OUT] jack instead of the [LINE OUT] jacks.

#### 3 INDIVIDUAL OUT MODE

**Setting Range: See below**

This allows you to adjust the assignment of audio signals between Sections and [INDIVIDUAL OUT] jacks.

**Off** ..... All audio from the PIANO, ENSEMBLE and MONO SYNTH Sections will be present at the [LINE OUT] jacks.

**Piano Stereo** ..... The audio from the PIANO Section will be routed to both [INDIVIDUAL OUT] jacks.

**Ensemble Stereo** ..... The audio from the ENSEMBLE Section will be present at both [LINE OUT] jacks.

**Synth Stereo** ..... The audio from the MONO SYNTH Section will be present at both [LINE OUT] jacks.

**Piano/Ensemble** ..... The PIANO Section will be routed to the Left [INDIVIDUAL OUT] jack and the ENSEMBLE Section will be routed to the Right [INDIVIDUAL OUT] jack.

**Piano/Synth** ..... The PIANO Section will be routed to the Left [INDIVIDUAL OUT] jack and the MONO SYNTH Section will be routed to the Right [INDIVIDUAL OUT] jack.

**Ensemble/Synth** ..... The ENSEMBLE Section will be routed to the Left [INDIVIDUAL OUT] jack and the ENSEMBLE Section will be routed to the Right [INDIVIDUAL OUT] jack.

**NOTE: IF the [INDIVIDUAL OUT] jacks are used, the selected Section(s) will not sound through the [LINE OUT] jacks.**

### LESLIE

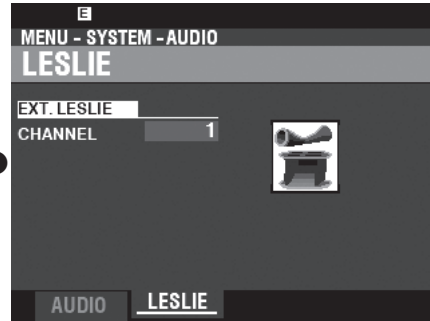

#### 1 EXTERNAL LESLIE CHANNEL

This allows you to adjust the correct routing of the audio signals depending on the Leslie Speaker connected to the instrument via the [LESLIE 11-pin] socket.

Channel Options	Leslie Rotary channel	LINE OUT and Leslie Stationary channels
1	Tone Wheel and Transistor Organ [BYPASS] not affected	PIANO/ ENSEMBLE/ MONO SYNTH
3	[BYPASS] affected	
1+LINE	Rotary	Stationary

**1** ..... If a single channel Leslie Speaker is connected, the audio from the Tone Wheel / Transistor Organs is sent to the Rotary Channel regardless of the status of the [BYPASS] button.

**3** ..... If a multi-channel Leslie Speaker is connected, the audio from the Tone Wheel / Transistor Organs is sent to the Rotary Channel only if the [BYPASS] button is "ON." If the [BYPASS] button is "OFF," the audio from the Tone Wheel / Transistor Organs is sent to the Stationary Channel(s).

**1+LINE** ..... If a single channel Leslie Speaker is connected, the audio from the Tone Wheel / Transistor Organs is sent to the Rotary Channel and the audio from the other Voice Sections will be sent to the [LINE OUT] jacks and can be heard through a connected amplifier or speaker system.

**NOTE: The Parameters in this Mode are System Parameters. You must Record these Parameters if you want their settings to be remembered the next time the instrument is turned "ON." See page 141 for instructions on how to do this.**

This FUNCTION Mode allows you to select the Parameters for the various Controls, including Foot Switches, Expression Pedals, controls on the Control Panel and the display.

## TO LOCATE THIS MODE:

[MENU/EXIT] - **SYSTEM** - **CONTROL** - [ENTER]  
 or, Press the [CONTROL] button.

## FOOT SWITCH 1/2

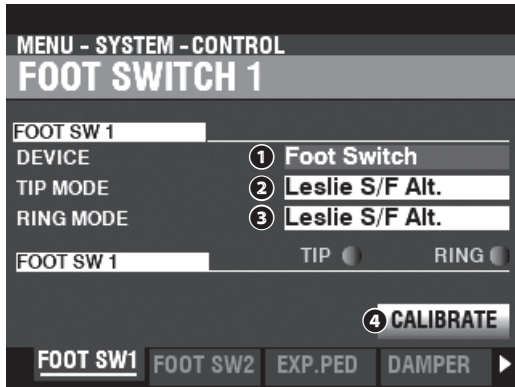

This Page allows you to select the Function of devices connected to the Foot Switch [FOOT SWITCH 1/2] jacks.

### 1 DEVICE

This allows you to select the device to be connected to the [FOOT SWITCH 1] jack.

- Foot Switch** ..... Foot Switch.
- Leslie Switch** ..... Leslie Switch (such as FS-10TL).

**NOTE: The FOOT SWITCH 2 jack will not accept a Leslie Switch.**

### 2 MODE - TIP

This allows you to select the function of the “Tip Mode” of a connected Foot Switch.

- Off** ..... No function.
- Expression** ..... Select this option if you wish to connect an Expression Pedal.
- Leslie S/F Alt, Mom, Tri** ..... Allows you to switch the Leslie Rotors among “Slow/Fast/Stop.”
  - Alt** ..... Alternates between “Fast/Slow” or “Fast/Stop” depending on the position of the [STOP] button.
  - TRI** ..... Switches to Stop when the foot switch is pressed and held down for approximately 1 second.
  - MOM** ..... Switches to Fast while the foot switch is held down. When released, it switches to either Slow or Stop depending on the position of the [STOP] button.
- Tone Wheel Brake** ..... Allows you to bend the pitch, with the amount being determined by a Parameter setting.
- Favorite Fwd, Rev** ..... Allows you to move Forward or Backward through the Favorites.
- Spring Shock** ..... Allows you to produce the effect of a Spring Reverb unit being jostled.
- Delay Time** ..... Allows you to adjust the Delay Time of the Effects, at the interval of pressing the Foot Switch. The delay is heard while the Foot Switch is held down (see page 77).
- Organ U&L Sustain** ..... Allows you to add Sustain to the UPPER/LOWER Part(s) of the ORGAN Section.
- Pedal To Lower** ..... Allows you to turn the [PEDAL TO LOWER] button “ON.”
- Bass 1C - Bass 3C** ..... Allows you to trigger the specified note of the PEDAL Part.
- ProChord** ..... Allows you to add ProChord harmony.

**NOTE: All of the above functions can be set for either Tip or Ring Mode. However, Ring Mode will have no effect if only one Foot Switch is connected to the FOOT SW jack.**

### 3 MODE - RING

This allows you to select the function of the “Ring Mode” of a connected Foot Switch.

### 4 CALIBRATE

This allows you to configure a Foot Switch to work properly with the SK PRO. To set this Parameter, move the cursor to this icon and press the [ENTER] button without pressing the Foot Switch.

### tips WHAT IS “TRS?”

TRS is an acronym for “Tip-Ring-Sleeve,” and refers to the fact that a connecting plug can have more than one connector. Using a Stereo Adapter, more than one Foot Switch can be connected to the SK PRO, thereby allowing you to control more than one function using the same Foot Switch jack.

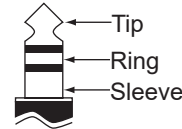

### tips FAVORITE FORWARD/REVERSE

By selecting “Favorite Fwd, Rev,” Favorites can be selected sequentially by using the Foot Switch to advance either forward or backward. Also, if either “1” or “10” are selected, the sequence will “roll over” to the next numbered Bank (see the illustration below).

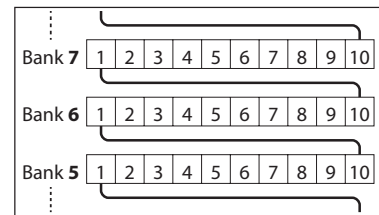

### tips SPRING SHOCK

“Spring Shock” occurs when the springs in a spring reverb unit move around and strike the reverb tank, resulting in a loud “bang.” This has usually been regarded as a negative effect; however, some modern and progressive music uses this as a musical effect. This Parameter allows you to introduce the effect of a spring reverb being jostled.

### tips BASS 1C - BASS 3C

Many jazz and blues organists provide a bass line with the left hand on the Lower Manual and strike one Pedal note at the onset of each bass note to give the effect of a plucked string bass (called a “thump”). The BASS 1C - BASS 3C Parameter allows the SK PRO to replicate this effect.

### tips CALIBRATE

Some Foot Switches, such as Hammond, are “+” or “positive” (make contact when pressed) while others are “-” or “negative” (break contact when pressed). The CALIBRATE Parameter allows you to configure a Foot Switch so that it will function correctly with the SK PRO.

## EXPRESSION PEDAL

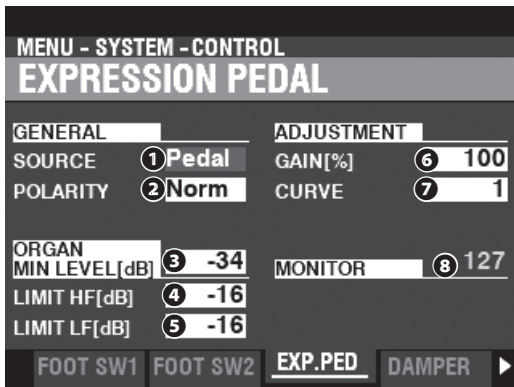

This Page allows you to control how a connected Expression Pedal will function.

### 1 SOURCE

This allows you to select the source of expression control.

**Exp. Pedal**..... Instrument volume is controlled by a connected Expression Pedal.

**MIDI**.....MIDI Expression Data (CC#11) will be received at the UPPER Keyboard Channel.

**Both**.....A connected Expression Pedal will control both instrument volume and MIDI Expression data.

### 2 POLARITY

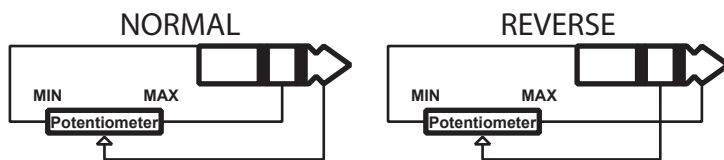

This allows you to set the polarity type of a connected Expression Pedal.

**Normal**.....Hammond EXP-50J pedal etc.

**Reverse**.....Expression Pedal with reverse polarity.

### 3 ORGAN MINIMUM LEVEL

**Setting Range:** Off, -40 ~ 0 [dB]

This allows you to set the amount of volume when the Expression Pedal is “closed” or set at its minimum position. At “0” no sound will be heard.

### 4 LIMIT HF

**Setting Range:** Off, -40 ~ 0 [dB]

This allows you to adjust the amount of High Frequencies (above 800Hz) that will be heard when the Expression Pedal is set at minimum.

### 5 LIMIT LF

**Setting Range:** Off, -40 ~ 0 [dB]

This allows you to adjust the amount of Low Frequencies (below 800Hz) that will be heard when the Expression Pedal is set at minimum.

### 6 GAIN

**Setting Range:** 70 ~ 130 [%]

This allows you to adjust the range of a connected Expression Pedal. You can select from “70%” through “130%,” however, the amount of audible change may differ depending on the specific Expression Pedal used. Use this Parameter to obtain the desired response from your particular pedal.

### 7 CURVE

**Setting Range:** 1 ~ 3

This allows you to set the “curve,” or change of expression value corresponding to the angle of the Expression Pedal when depressed (see the illustration on the right).

### 8 MONITOR

**Setting Range:** 0 ~ 127

This allows you to display the current Expression Value, with “0” being minimum Expression (no audible sound) and “127” being maximum Expression. The Expression Monitor can be useful as a troubleshooting aid if you either don’t hear any sound or can’t change the volume using a connected Expression Pedal.

### tips EXPRESSION LIMIT

On many home audio components, there is a control called “Loudness.” This is intended to correct an anomaly of the human ear whereby high and low frequencies appear to be lacking at low volume levels.

The SK PRO incorporates a “Loudness” algorithm similar to the one found on home audio. At lower volume levels, both high and low frequencies are boosted so that a flatter frequency response will be perceived by the ear.

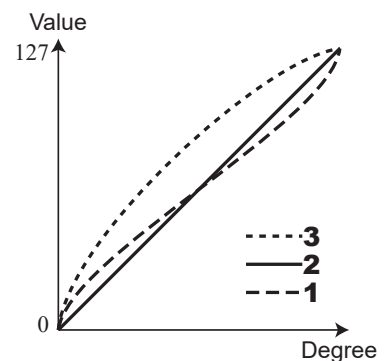
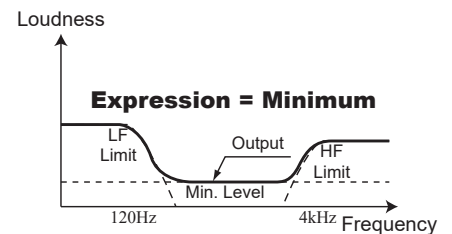
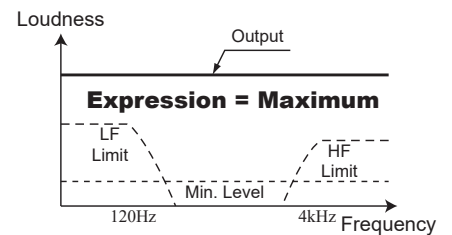

**DAMPER**

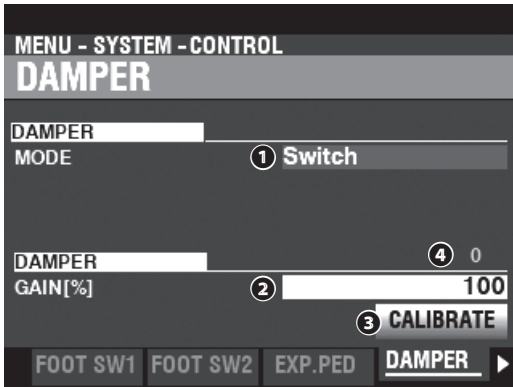

This Page allows you to adjust Parameters for the Damper Pedal.

**1 TYPE**

This allows you to adjust the type of the Damper Pedal to connect.

**SWITCH**..... Use "switch" type pedal such as VFP1

**HALF-Y**..... Use "potentiometer" type Y

**HALF-R**..... Use "potentiometer" type R

**HALF-K**..... Use "potentiometer" type K

**2 GAIN**

**Setting Range: 70 ~ 130 [%]**

This allows you to adjust the range of a connected Damper Pedal. You can select from "70%" through "130%," however, the amount of audible change may differ depending on the specific Damper Pedal used. Use this Parameter to obtain the desired response from your particular pedal.

**3 CALIBRATE**

This allows you to configure a Damper Pedal to work properly with the SK PRO. To set this Parameter, move the cursor to this icon and press the [ENTER] button without pressing the Damper Pedal.

**4 MONITOR**

This allows you to see the current Damper value.

**tips DAMPER TYPES**

There are various types of Damper or Sustain Pedals. The SK PRO supports the types shown below.

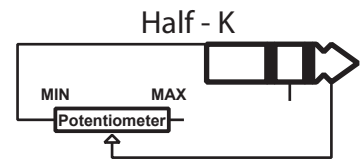
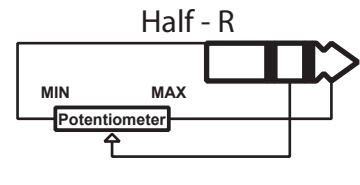
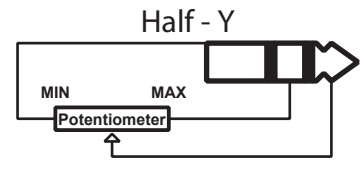
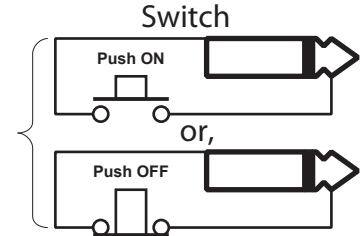

**USER**

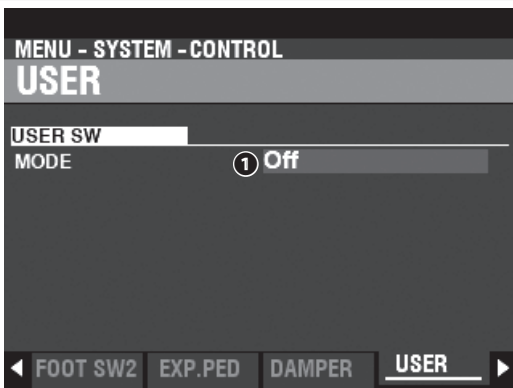

**1 MODE**

This allows you to assign a function to the [USER] button.

**Off**..... No function.

**Pedal Sustain**..... Allows you to turn Pedal Sustain "ON" or "OFF"

**Organ Upper Sustain**..... Allows you to turn Organ Upper Sustain "ON" or "OFF"

**Organ Lower Sustain**..... Allows you to turn Organ Lower Sustain "ON" or "OFF"

**Tone Wheel Brake**..... Allows you to bend the pitch, with the amount being determined by a Parameter setting.

**Spring Shock**..... Allows you to produce the effect of a Spring Reverb unit being jostled.

**MFx2 Delay Time**..... Allows you to adjust the Delay Time of the Effects, at the interval of pressing the [USER] button. The delay is heard while the [USER] button is held down (see page 77).

**MFx1/2**..... Allows you to turn each Section Effect "ON" or "OFF"

## PITCH BEND

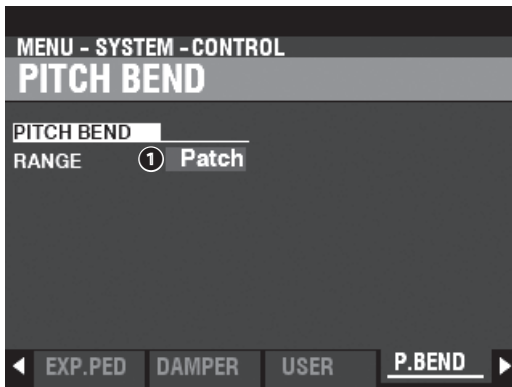

This allows you to adjust the Pitch Bend functions.

### ① RANGE

**Settings:** Patch, 0 ~ 12 [semitones]

This allows you to adjust how the [PITCH BEND] wheel will respond when a Combination or Patch is selected.

**Patch**..... Uses the value specified for the Combination or Patch.

**0 ~ 12**..... Sets the Pitch Bend range by semitones priority over the Combination or Patch.

## TONE WHEEL BRAKE

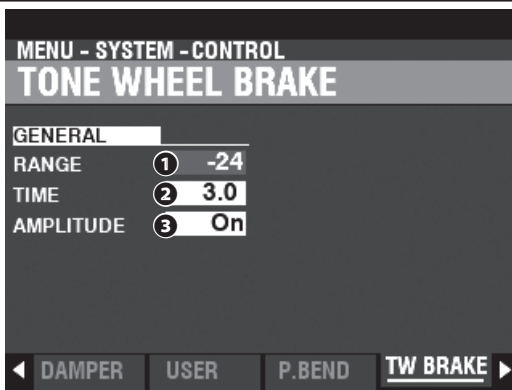

This allows you to adjust the Tone Wheel Brake effect.

### ① RANGE

**Setting Range:** -24 ~ +12 [semitones]

This allows you to adjust the range of the pitch change.

### ② TIME

**Setting Range:** 0.1 ~ 5.0 [seconds]

This allows you to adjust the rate at which the pitch changes.

### ③ AMPLITUDE

**Settings:** Off, On

This allows you to adjust whether the Volume changes or not along with the pitch.

### tips TONE WHEEL BRAKE

On a vintage B-3/C-3/A-100, the synchronous motor running the tone generator turns at a constant speed; therefore "pitch bending" is not possible. However, some jazz players discovered that by turning the RUN switch "OFF" then quickly back "ON" again, a pseudo "pitch-bend" effect could be created. You can replicate this effect using this function.

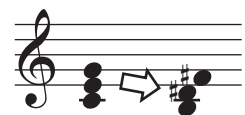

## DISPLAY

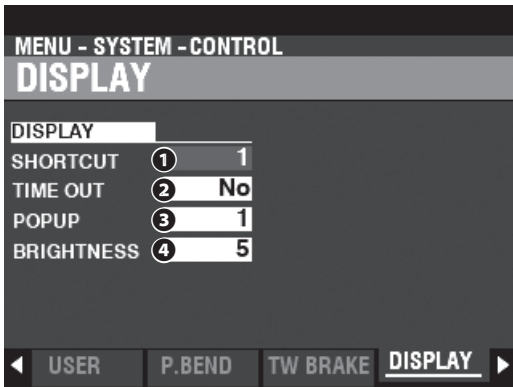

This Page allows you to adjust the performance of the display.

### 1 SHORTCUT

**Setting Range:** 0 ~ 2 [sec], No

This allows you to select how long a button must be held before the Menu Page controlled by that button appears.

**NOTE:** If you select "No" (the Shortcut feature is disabled).

### 2 TIME OUT

**Setting Range:** 4 ~ 16 [sec], No

This allows you to select how long the display will continue to show a Menu Page before reverting to PLAY Mode.

**NOTE:** If you select "No," the current Menu Page will continue to display until another page is selected.

### 3 POP UP

**Setting Range:** No, 0.5 ~ 2.0 [sec]

This allows you to select the interval at which a "Pop Up" is displayed when you move a knob such as [REVERB] or one of the Voice Section [VOLUME] controls.

**NOTE:** If you select "No," the current Pop Up will continue to display until another page is selected.

### 4 BRIGHTNESS

**Setting Range:** 1 ~ 10

This allows you to adjust the brightness of the backlight of the display.

## PANEL

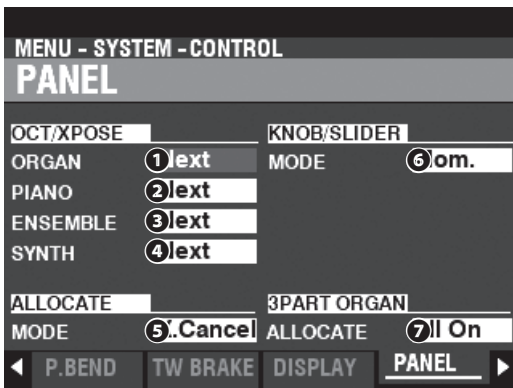

This Page allows you to adjust the performance of the various controls on the Control Panel.

### 1 OCT / XPOSE - ORGAN

### 2 OCT / XPOSE - PIANO

### 3 OCT / XPOSE - ENSEMBLE

### 4 OCT / XPOSE - SYNTH

**Setting Range:** Every, Next

These allow you to adjust how the OCTAVE [DOWN] [UP] buttons control Octave selection or Transposition.

**Every** ..... The Octave or Transposition will change while keys are pressed and held.

**Next** ..... If a key or keys are pressed and held and the Octave or Transposition is changed, the



key(s) must be released and pressed again before the Octave or Transposition takes effect.

**5 ALLOCATE MODE**

**Settings: Additive, X-Cancel**

This allows you to select the performance of the [ALLOCATE] buttons.

**Additive**..... The [ALLOCATE] buttons will turn "ON" and "OFF" individually.

**X-Cancel**..... "Cross-Canceling" - When one [ALLOCATE] button is turned "ON," any other [ALLOCATE] buttons that are "ON" will turn "OFF." If an [ALLOCATE] button is already "ON," pressing and holding it while turning another [ALLOCATE] button "ON" will light both buttons.

**6 KNOB / SLIDER MODE**

**Settings: Mom, Access**

This allows you to adjust how a value is affected when a knob or slider is moved.

**Mom**..... When a knob or slider is moved, the value will change immediately.

**Across**..... When a knob or slider is moved the value will not change until the current value is arrived at by the movement of the knob or slider, at which point the value will change.

**tips USING "MOM" AND "ACROSS"**

When "Mom" is selected and a knob or slider is moved, the value changes instantly. However, there may be occasions when you want a value to change gradually instead of suddenly. Select "Across" to change values gradually. This is especially helpful when selecting Patches since you can use "Across" to "morph" one Patch into another.

**7 3 PART ORGAN ALLOCATE**

**Settings: No, All On**

This allows you to select how the [3 PART ORGAN] button interacts with the [ALLOCATE] [ORGAN] button.

**No**..... The [3 PART ORGAN] button has no effect to the [ALLOCATE] [ORGAN] button.

**All On**..... When the [3 PART ORGAN] button is turned "ON," all ORGAN Parts turn "ON," the [SPLIT] button turns "ON" and other Voice Sections are turned "OFF."

**KEYBOARD**

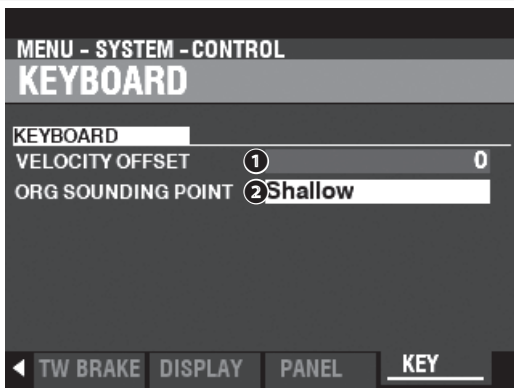

This Page allows you to adjust the performance of the keyboard of the SK PRO.

**1 VELOCITY OFFSET**

**Setting Range: -32 ~ ±0 ~ +32**

This allows you to adjust the relative loudness of notes played on the keyboard.

**NOTE: The note velocity of the SK PRO is from "0" to "127." These are the upper and lower limits.**

**2 ORGAN SOUNDING POINT**

**Setting Range: Shallow, Deep**

This allows you to select the sounding point of the ORGAN Section.

**Shallow**..... The ORGAN Section sounds at a shallower key depth than the other Voice Sections.

**Deep**..... The ORGAN Section sounds at the same key depth as the other Voice Sections.

**NOTE: If other Voice Sections are allocated along with the ORGAN Section ([ALLOCATE] buttons "ON"), the sounding point of the ORGAN Section will automatically be set at "Deep."**

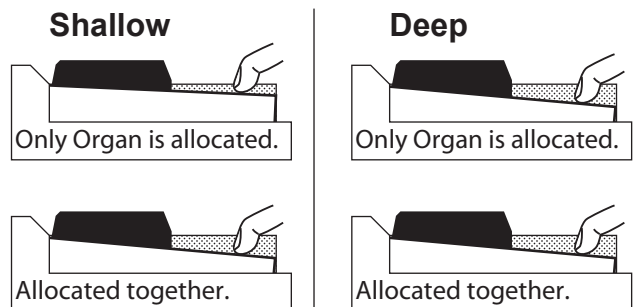

**NOTE: The Parameters in this Mode are System Parameters. You must Record these Parameters if you want their settings to be remembered the next time the instrument is turned "ON." See page141 for instructions on how to do this.**

This FUNCTION Mode allows you to select which Parameters of the instrument will be Recorded as part of a Patch.

## TO LOCATE THIS MODE:

[MENU/EXIT] - **SYSTEM** - **PATCH LOAD** - [ENTER]

All the Parameters described here have “ON” and “OFF” settings.

**On**..... The Parameter setting will be remembered as part of a Patch

**Off** ..... The Parameter setting will not be re,membered as part of a Patch.

## COMBI PATCH LOAD

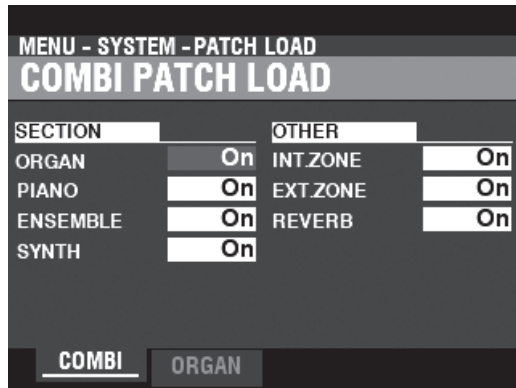

This Page allows you to select which Parameters to include as part of a Combination.

**ORGAN** ..... ORGAN Section.

**PIANO** ..... PIANO Section.

**ENSEMBLE** ..... ENSEMBLE Section.

**SYNTH**..... MONO SYNTH Section.

**INT. ZONE** ..... Internal Zones.

**EXT. ZONE** ..... External Zones.

**REVERB**..... Reverb effect.

## ORGAN PATCH LOAD

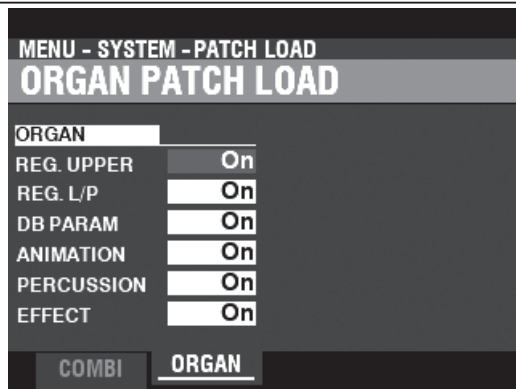

This Page allows you to select which Parameters to include as part of an ORGAN Patch.

**REG. UPPER** ..... UPPER Drawbar Registration.

**REG. L/P**..... LOWER and PEDAL Drawbar Registrations.

**DB PARAM** ..... General ORGAN Section Parameters such as Drawbar (except Drawbar Registration), Contact & Sustain.

**ANIMATION**..... Vibrato and Chorus, Leslie.

**PERCUSSION**..... Percussion Parameters.

**EFFECT**..... Matching Transformer, Overdrive, Multi Effects 1&2, Equalizer.

### tips PATCH LOAD EXAMPLE

When a Combination is selected,

**Example 1:** On a vintage B-3/C-3/A-100, changing an Upper Preset will change only the Drawbar registration for the Upper Manual. To replicate this on the SK PRO, turn the ORGAN and REG. UPPER Parameters “ON” and turn all the other Parameters “OFF”

**Example 2:** To change the other Voice Sections except ORGAN, turn the ORGAN Parameter “OFF” and turn the other Voice Section Parameters “ON.”

**NOTE:** The Parameters in this Mode are System Parameters. You must Record these Parameters if you want their settings to be remembered the next time the instrument is turned “ON.” See page141 for instructions on how to do this.

This FUNCTION Mode allows you to control how FAVORITES are recalled using the numbered [FAVORITE] buttons.

## TO LOCATE THIS MODE:

[MENU/EXIT] - **SYSTEM** - **FAVORITES** - [ENTER]

### ACCESS

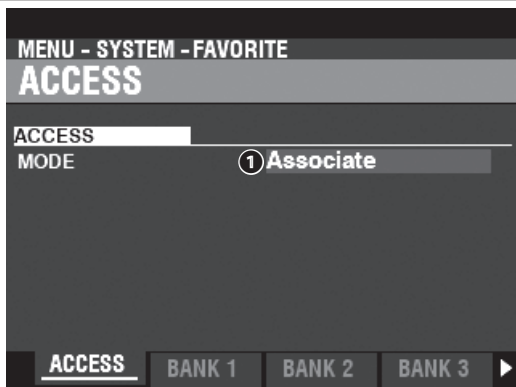

#### 1 ACCESS MODE

This Page allows you to select how the numbered [FAVORITE] buttons recall Combinations.

##### Associate:

This allows you to touch a numbered [FAVORITE] button to recall the Combination associated with that button.

To associate a Combination with a numbered button, Touch and Hold the red [RECORD] button and touch one of the numbered [FAVORITE] buttons.

##### Bundle:

This allows you to recall Bundles (Combination Parameters, ORGAN and MONO SYNTH Patches).

##### Direct:

This allows you to recall Combinations and Bundles by direct numerical input.

To recall a Combination or Bundle in this Mode, use the numbered [FAVORITE] buttons to enter a 3-digit number representing the Combination you want and press the [ENTER] button.

B001 ... [BANK]B, [1], [ENTER]

B010 ... [BANK]B, [1], [10], [ENTER]

U001 ... [BANK]U, [1], [ENTER]

U010 ... [BANK]U, [1], [10], [ENTER]

F001 ... [BANK]F, [1], [ENTER]

F010 ... [BANK]F, [1], [10], [ENTER]

**NOTE: This mode cannot associate a numbered [FAVORITE] button to a Combination.**

### BANK 1 - 10

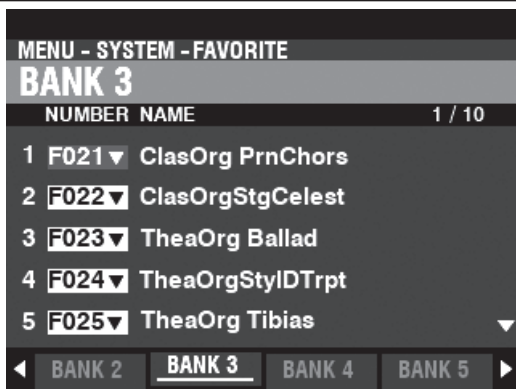

This allows you to associate and confirm the assignment of Combinations to numbered [FAVORITE] buttons.

### DISPLAY

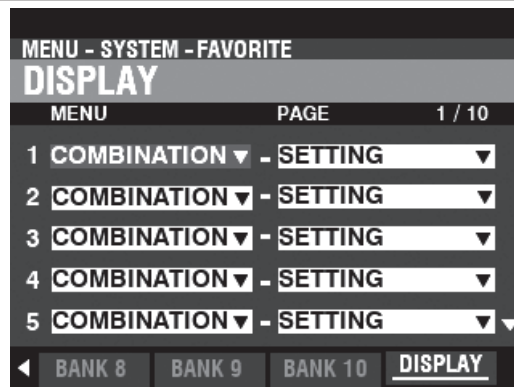

This allows you to associate and confirm the assignment of display pages to numbered buttons.

**NOTE: You can also associate a numbered button and a display page by pressing a numbered button while holding the [SHIFT] and [RECORD] buttons together.**

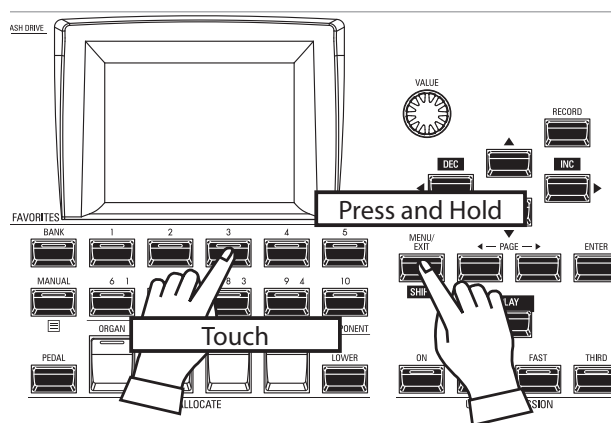

To locate an associated display page, press and hold the [SHIFT] button and press a numbered [FAVORITE] button.

**NOTE: The Parameters in this Mode are System Parameters. You must Record these Parameters if you want their settings to be remembered the next time the instrument is turned "ON." See page 141 for instructions on how to do this.**

This FUNCTION Mode allows you to adjust the AUTO POWER OFF and USB Parameters.

### TO LOCATE THIS MODE:

[MENU/EXIT] - **SYSTEM** - **GLOBAL** - [ENTER]

## POWER

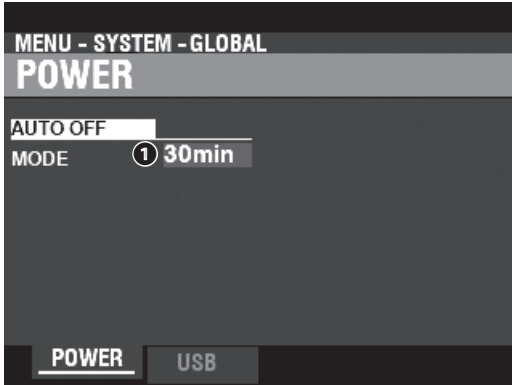

### AUTO OFF

#### ① MODE

This allows you to select whether the power to the instrument is automatically turned "OFF" after a certain time period.

**30min** ..... The AC power to the instrument will turn "OFF" after 30 minutes have elapsed with no keys or buttons being pressed.

**Disable** ..... The instrument will turn "ON" or "OFF" with the AC Power Switch, but not turn "OFF" automatically.

## USB

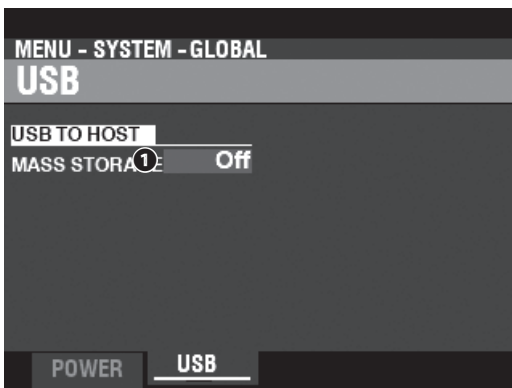

This allows you to Load and Save files from the instrument's Internal Memory and access files to or from a host computer via a USB cable.

**NOTE:** See page 162 "USB Mass Storage" for more details.

To Record the System Parameters of the SK PRO, do the following:

## ① PRESS THE RED [RECORD] BUTTON

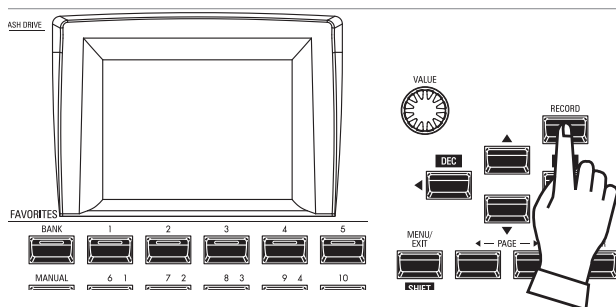

After you have made your changes to SYSTEM Parameters, press the red [RECORD] button. The RECORD Page will display.

## ② SELECT THE ITEM TO RECORD

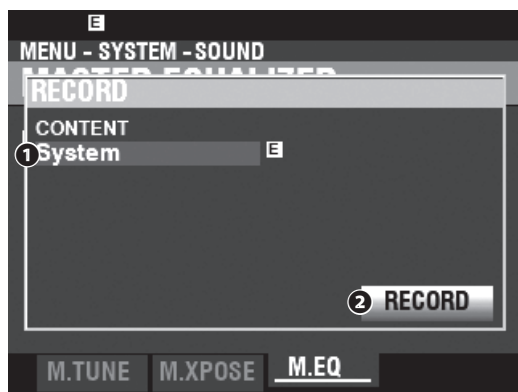

### ① CONTENT

The content to Record will be highlighted.

**System** ..... System Parameters.

**NOTE:** If edits have been made to a System Setting, an "E" will appear to the right of the CONTENT icon.

## ③ RECORD THE SETTING

Press the [ENTER] button. The message shown below will display for approximately 1 second:

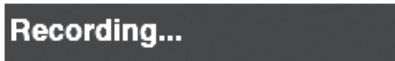

**NOTE:** Do not turn the power "OFF" while the above message is displaying.

**NOTE:** If you DO NOT wish to Record, press the [MENU/EXIT] or [PLAY] button instead of the [ENTER] button.

## ④ RETURN TO THE PLAY MODE

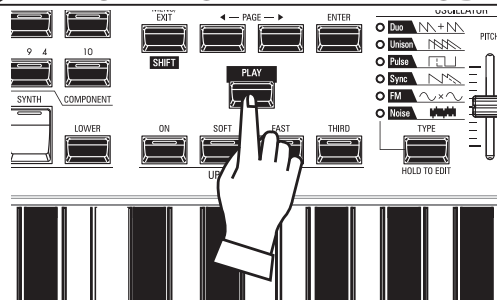

Press the [PLAY] button to return to the PLAY mode.

# DELETE

This FUNCTION Mode allows you to delete “U” (User) contents from the instrument.

## TO LOCATE THIS MODE:

[MENU/EXIT] - **SYSTEM** - **DELETE** - [ENTER]

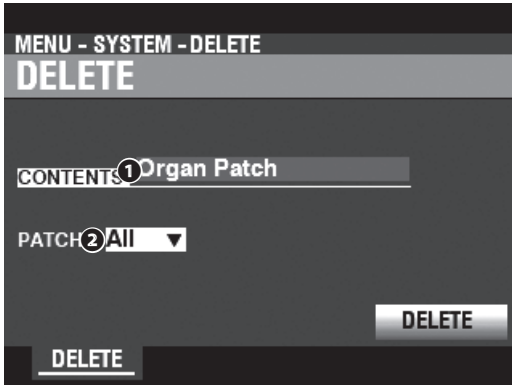

To delete User content(s), do the following:

### 1 CONTENT

From the above screen, use the [VALUE] knob to select the content to delete.

**Bundle**  
**Combination**  
**Organ Patch**  
**Piano/Ens Patch**  
**Synth Patch**  
**Custom Tone Wheel**  
**Custom Pedal Registration**  
**Custom Leslie Cabinet**  
**Custom Pipe**

### 2 NUMBER

Use the [DIRECTION] [▼] button to move the cursor down and select the item to Delete. You can select each individual User or Bundle Number as well as “ALL” (all the User or Bundle Numbers).

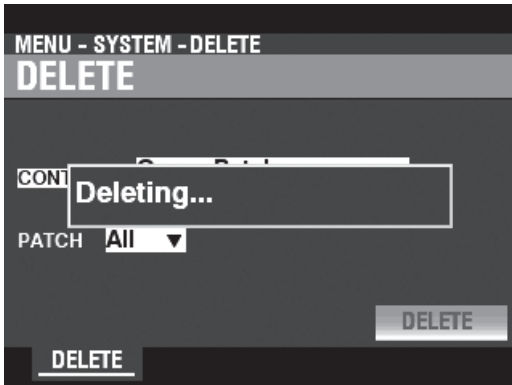

### 3 DELETE

Use the [DIRECTION] [▼] button to move the cursor down to the DELETE icon and press the [ENTER] button. The display will show “Deleting...” for approximately 1 second (see the illustration above). When the message “Deleting...” disappears, the procedure is complete and the DELETE Page will reappear.

**NOTE:** If you **DO NOT** wish to Delete, press the [MENU/EXIT] or [PLAY] button instead of the [ENTER] button.

### ⚠ CAUTION

Do not turn the power “OFF” while the above message is displaying. Doing so may cause a malfunction.

This FUNCTION Mode allows you to reset the SK PRO to factory-default settings.

### TO LOCATE THIS MODE:

[MENU/EXIT] - **SYSTEM** - **DEFAULT** - [ENTER]

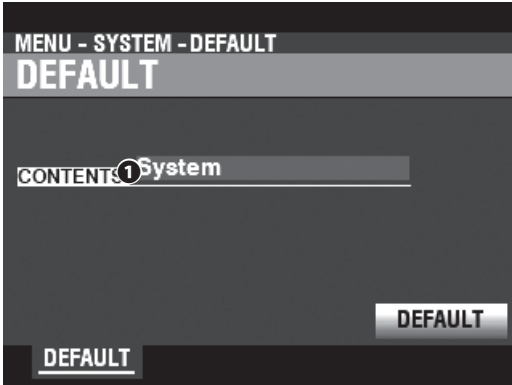

To reset the instrument to the factory-default settings, do the following:

#### 1 CONTENT

From the above screen, use the [VALUE] knob to select the content to be initialized.

- System.....System Parameters.
- All .....All the contents.

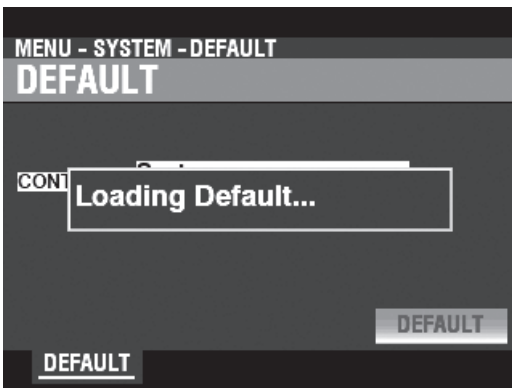

#### 2 DEFAULT

Use the [DIRECTION] [▼] button to move the cursor to the [DEFAULT] icon and press the [ENTER] button. The display will show “Loading Default...” for approximately 1 second. When the message “Loading Default...” disappears, the Default procedure is complete and the DEFAULT Page will reappear.

**NOTE: If you DO NOT wish to Default the instrument,, press the [MENU/EXIT] or [PLAY] button instead of the [ENTER] button.**

#### ⚠ CAUTION

Do not turn the power “OFF” while the above message is displaying. Doing so may cause a malfunction.

This FUNCTION Mode allows you to see the status of connected devices as well as the status of the currently installed software. It also allows you to update the system software.

## TO LOCATE THIS MODE:

[MENU/EXIT] - **SYSTEM - INFORMATION** - [ENTER]

## STATUS DISPLAY

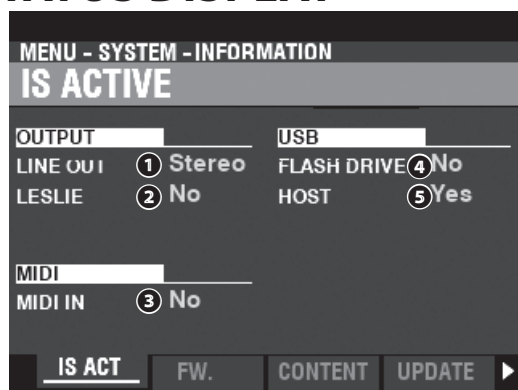

## IS ACTIVE

This allows you to see which peripheral devices are connected.

### 1 LINE OUT

**Settings: Mono, Stereo**

This allows you to adjust how the sounds from the SK PRO are routed to the [LINE OUT] jacks.

**NOTE: The full effect of the sounds produced by the SK PRO is best heard in Stereo (both LINE OUT jacks connected to two sound sources physically separated). If only the L/MONO jack is connected, the "Pan" function will not be heard.**

### 2 LESLIE

**Settings: No, Yes**

This allows you to see the connecting status of the SK PRO to a Leslie Speaker Cabinet via the 11-pin [LESLIE] socket.

### 3 MIDI IN

**Settings: No, Yes**

This allows you to see the connecting status of the SK PRO to a MIDI device via the [MIDI IN] Port.

**NOTE: This shows the receiving condition of the "Active Sense" message. It may display "No" even if correctly hooked-up if the connected device cannot send it (such as the XPK-100 Pedalboard).**

### 4 FLASH DRIVE

**Settings: No, Yes**

This allows you to see the connecting status of a USB Flash Drive. Use this Parameter to determine if a USB Flash Drive is compatible with the SK PRO.

### 5 HOST

**Settings: No, Yes**

This allows you to see the connecting status between the SK PRO and a computer via a USB cable.

## VERSION - FIRMWARE

This allows you to see the versions of the main system software.

**RELEASE**..... Release Number.

**MAIN**..... Main Processor.

**SUB**..... Sub Processor.

**KEY SCAN**..... Keyscan Processor.

**PANEL**..... Control Processor.

## VERSION - CONTENTS

This allows you to see the versions of the Voice Cells.

**F. CONTENT**..... Factory Contents. This is integrated pre-loaded data. The details are listed below.

**TW.ORGAN**..... Tone Wheel Organ.

**TR.ORGAN 1**..... Transistor Organ 1.

**TR.ORGAN 2**..... Transistor Organ 2.

**PIPE**..... Pipe Organ.

**PEDAL DB**..... Pedal Drawbars.

**A.PIANO**..... Acoustic Piano.

**HARPSI**..... Harpsichord.

**CHRO PERC**..... Chromatic Percussion.

**ETHNIC**..... Ethnic.

**WIND**..... Wind.

**CHOIR**..... Choir.

**BASS**..... Bass.

**FREE REED**..... Free Reed.

**E.PIANO**..... Electric Piano.

**CLAV**..... Clav.

**GUITAR**..... Guitar.

**SFX**..... Sound Effects.

**STRINGS**..... Strings.

**SYNTH PAD**..... Synth Pad.

**SYNTH LEAD**..... Synth Lead.

**PERCUSSION**..... Percussion.

## UPDATE

See "Updating the Software" on page 145 for more information.



This FUNCTION Mode allows you to update the internal software of the SK PRO from the USB Flash Drive or Internal Memory.

## TO LOCATE THIS MODE:

[MENU/EXIT] - **SYSTEM - INFORMATION** - [ENTER] - **UPDATE**

## PREPARING OPERATING TIME

The update process may take several minutes depending on the extent of the update. Therefore, if you are updating the System Software, be sure you set aside enough time in an environment with a continuous AC power supply.

## OPERATION PROCEDURE

### ① DOWNLOAD THE UPDATE

Go to the Hammond website for your region and download the software update to the desktop of your computer. It will be a compressed file containing several files called a ".ZIP" file

### ② UNZIP THE FILE

Find the .ZIP file on your Desktop and un-ZIP it. A folder will be created on your desktop having the same name as the .ZIP file which will contain the software update files, called ".SYS" files.

### ③ COPY THE ".SYS" FILE(S)

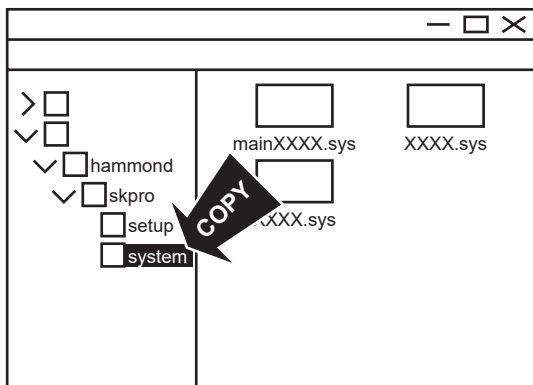

Insert a USB Flash Drive you have previously formatted in the SK PRO into your computer and copy the .SYS files into the sub-folder shown above.

**NOTE: Please see page 161 for instructions on how to Format a USB Flash Drive.**

You can also use the Internal Memory instead of a USB Flash Drive to access the .SYS update files, as shown above.

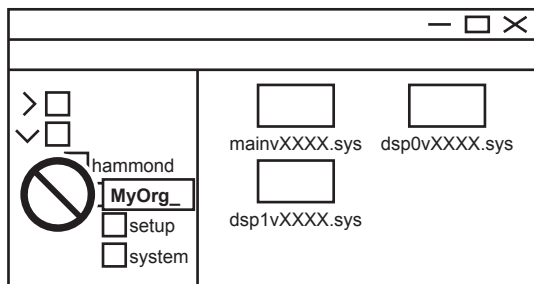

**⚠ CAUTION**  
Do not re-name or delete the folders or format the Internal Memory from the computer. Doing so may cause a malfunction.

### ④ INSERT THE USB FLASH DRIVE

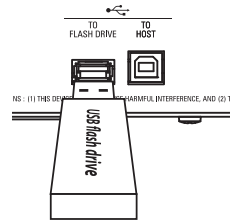

Turn the power to the SK PRO "ON."

Remove the USB Flash Drive from your computer and insert it into the [TO FLASH DRIVE] Port of the SK PRO. The message, "Confirming USB..." will display for approximately 1 second. Please wait for this message to disappear.

### ⑤ SELECT THE MEDIA TO READ

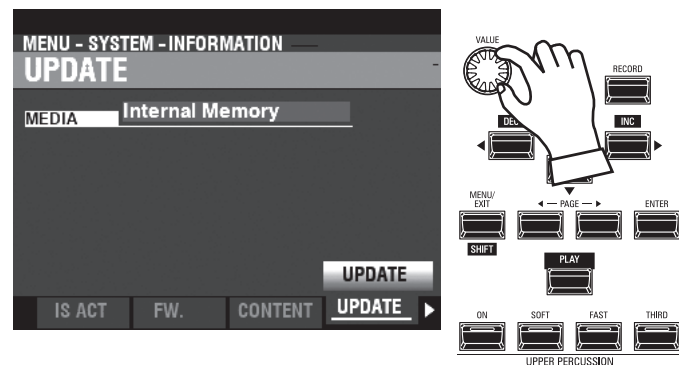

Use the [VALUE] knob to select the Media containing the .SYS update files. Select the "USB Flash" or "Internal Memory."

**NOTE: "USB Flash" cannot be selected if no USB Drive is present at the [TO FLASH DRIVE] USB Port.**

**NOTE: If there are no ".SYS" files in the correct folders, the message "No Update File" will display.**

### ⑥ START THE UPDATE

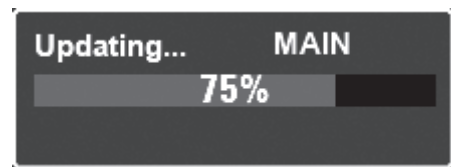

Use the [DIRECTION] [▼] button to move the cursor to the [UPDATE] icon and press the [ENTER] button. You will see a status bar similar to the one shown above during the Update procedure. Each file being installed will display a separate status bar.

When the update is finished, the message "Please power off!!!" will display. When the power to the SK PRO is next turned "ON," the updated software will take effect.

---

\*\*\*THIS PAGE INTENTIONALLY LEFT BLANK TO PRESERVE PAGE FORMATTING \*\*\*



## WHAT IS “MIDI”?

“MIDI” (**M**usical **I**nstrument **D**igital **I**nterface) is the musical instrument industry standard for exchanging performance information between electronic musical instruments as well as sequencers, effects, lighting and sound reinforcement gear, etc.

The MIDI standard allows instruments made by different manufacturers to communicate with each other.

Many types of data can be transmitted and received, including performance information, Parameter settings, and global commands.

## WHAT IS “USB”?

USB (**U**niversal **S**erial **B**us) is an industry standard for connection, communication and interfacing between computers, peripherals and other electronic devices. There are many different types of USB connectors; however the SK PRO implements Type “A” and Type “B” connectors, which are the most common types for electronic musical instruments.

## MIDI/USB JACKS ON THE SK PRO

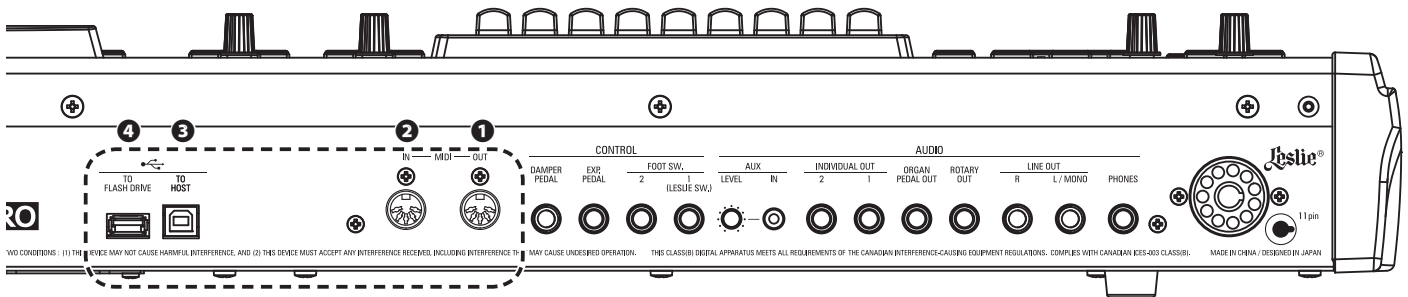

### 1 MIDI OUT Port

This Port transmits performance information to an external MIDI device such as a sound module, sequencer or Digital Audio Workstation (DAW).

### 2 MIDI IN Port

This Port receives MIDI information from an external MIDI device such as a sequencer or DAW.

### 3 USB TO HOST Port

This Port will connect to a computer.

### 4 USB FLASH DRIVE Port

This Port will accept a USB Flash Drive.

## WHAT MIDI CAN DO ON THE SK PRO

The MIDI implementation of the SK PRO allows you to:

- ♦ Use a MIDI keyboard/pedalboard to expand the playing versatility.
- ♦ Control an external sound generator such as a synthesizer or sampler.
- ♦ Record/playback performances to an external sequencer or computer.

For easier access to those settings, the SK PRO is equipped with **MIDI Templates**.

For a fuller explanation of MIDI Templates, see page 156.

## USB TO HOST

The USB TO HOST Port will do the following:

- ♦ Send / receive the MIDI data (Keyboard channel Upper, Lower, Pedal and system exclusive messages).\*1
- ♦ Send and Receive Setup and System files.
- ♦ Compliant with USB AUDIO Class 1.0.

### tips USB AUDIO CLASS

The SK PRO is compliant with USB AUDIO Class 1, the generic device driver which comes pre-installed on both Windows or Mac OS. This means you can use the USB TO HOST Port to connect the SK PRO to a computer and transmit and receive a MIDI data stream without an exclusive device driver.

## **MIDI CHANNEL**

---

MIDI information travels along **MIDI Channels**. These channels are similar to television channels, in that they provide a way to transmit and receive MIDI information as well as to differentiate among MIDI information sent to different devices. The current MIDI specification provides for 16 Channels, all of which travel along a single cable.

**NOTE: In order for MIDI devices properly to communicate, both the sending and receiving devices must be set to the same MIDI Channel.**

## **MAIN MIDI MESSAGE**

MIDI information is grouped into Channel Messages for each of the 16 MIDI Channels and a System Message which applies to all Channels.

**NOTE: See the MIDI IMPLEMENTATION CHART on page 196 for more details.**

## **CHANNEL MESSAGES**

---

### **NOTE ON/NOTE OFF/VELOCITY DATA**

---

This data tells: which key (Note Number) is played, at what speed (Velocity) and when and for how long the note is to sound (Note On/Off).

## **PROGRAM CHANGES**

---

### **UPPER Keyboard Channel**

.....Changes the Combinations of the SK PRO.

### **External Zone Channels**

.....Sends Program Change data to external MIDI equipment.

## **CONTROL CHANGES**

---

Control Changes are transmitted and received in response to manipulations of controls on the Control Panel, connected peripheral devices such as Foot Switches or an Expression Pedal, or other MIDI controller information.

## **SYSTEM MESSAGES / SYSTEM EXCLUSIVE MESSAGES**

---

These are messages which are unique to a particular manufacturer or between instruments of the same model from the same manufacturer.

## **MEMORY DUMP**

---

The SK PRO can transmit the settings in the instrument's memory in the form of a series of System Exclusive (SysEx) messages. This is referred to as a Memory Dump. Doing this allows you to make a backup copy of your settings. If you want to restore previous settings saved to an external MIDI device, the SK PRO can also receive a Memory Dump.

# MIDI STRUCTURE OF THE SK PRO

The SK PRO can transmit and receive MIDI data on **Keyboard Channels** as well as transmit MIDI data on **External Zones**. The following illustrations and paragraphs below explain this in more detail.

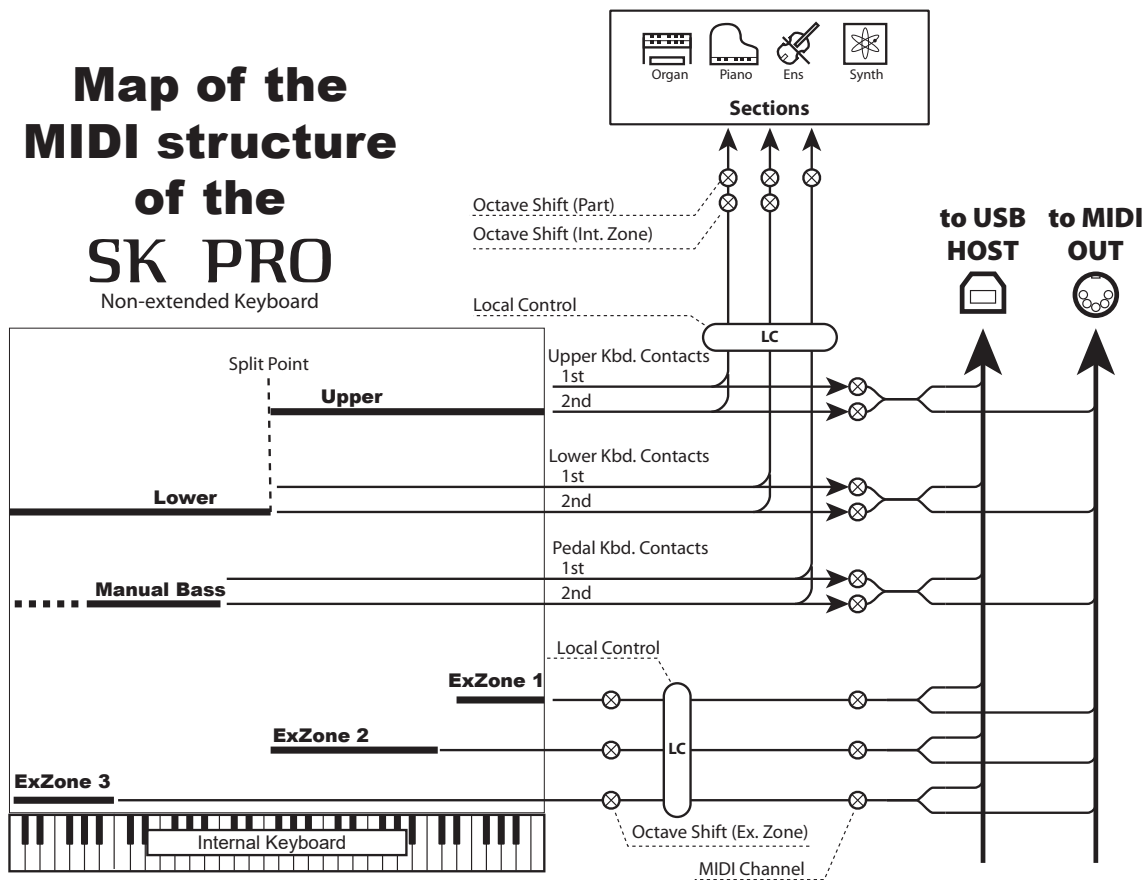

## KEYBOARD (INTERNAL) CHANNELS

The internal sounds of the instrument will play on what are called the **Keyboard** or **Internal Channels**.

The Keyboard Channels transmit Note On/Note Off and Velocity data from the Upper, Lower and Pedal Keyboards. These channels will both send (MIDI OUT) and receive (MIDI IN) data, and are therefore used when recording and playing back sequences.

**NOTE: The Upper Keyboard Channel, in addition to Note On/Note Off and Velocity data, also is used for transmitting Controller data.**

## EXTERNAL ZONES

The External Zone Channels allow you to use the SK PRO as a MIDI Master Keyboard. These allow you to play additional sounds from another MIDI instrument such as a sound module. The External Zones transmit but do not receive MIDI data - in other words, they are MIDI OUT only.

There are three (3) External Zone Channels which can be assigned to the Upper Manual, Lower Manual or Pedals. In addition, different configurations can be Recorded to different Patches - for example, one Patch can have all three External Zones assigned to the Upper Manual, another Patch can have one External Zone each for Upper, Lower and Pedals, etc.

## EXPANDED KEYBOARDS

When MIDI keyboards are used to expand the LOWER and/or PEDAL Parts, they will not only play the internal voices of the SK PRO, but also transmit MIDI data to other MIDI devices via the MIDI OUT port. Thus, both the Keyboard Channels and the External Zones will respond from connected MIDI keyboards, as if the Expanded Keyboards were "built-in" as an integral part of the SK PRO.

# Map of the MIDI structure of the SK PRO

Extended Keyboard

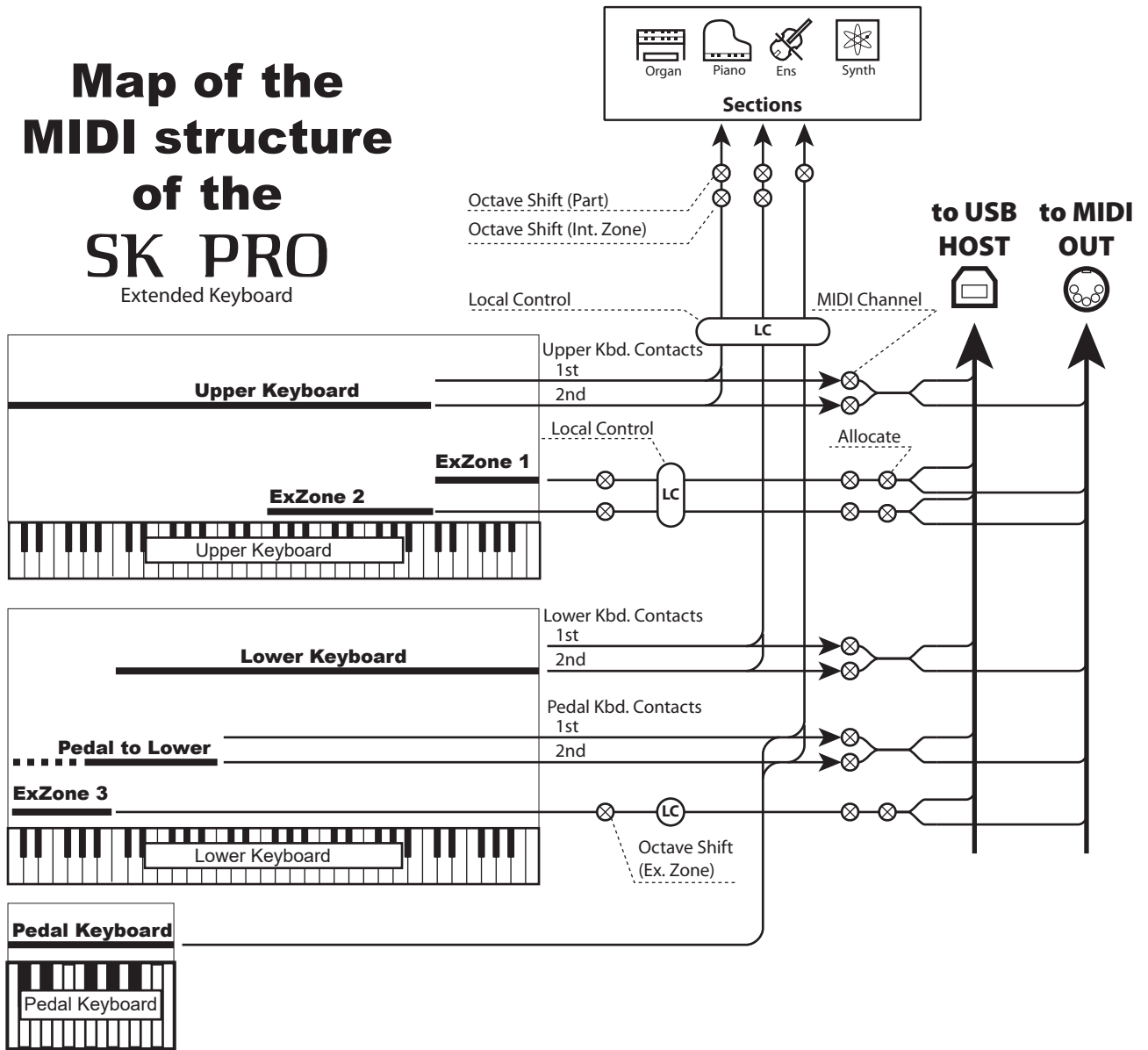

# USING AN EXTERNAL SEQUENCER

This section explains how to record and play back a performance on the SK PRO using either an external MIDI sequencer or a computer on which is installed a Digital Audio Workstation, or DAW.

## RECORDING AND PLAYING BACK A PERFORMANCE

In order to Record and Play a MIDI performance, connect the MIDI cables as shown in the illustration on the right.

### RECORD

1. Connect MIDI cables as shown on the right.
2. Go to the MIDI FUNCTION Mode and select the MIDI Template appropriate for your system. You can select "Sequence," "Upper," "Lower," "Pedal," "Upper+Pedal" or "Lower+Pedal."

**NOTE: This connection cannot record MIDI data sent via External Zones.**

3. Configure the MIDI Channel on your sequencer or DAW. If you are recording the UPPER Keyboard only, set the MIDI Channel on your sequencer to record Channel "1." To record all keyboards, set your sequencer to record Channels "1," "2" and "3." (UPPER=1, LOWER=2 and PEDAL=3).
4. Start recording on your sequencer or DAW.
5. If you need to send System Exclusive data, etc., transmit a MIDI Memory Dump.
6. Start your performance.

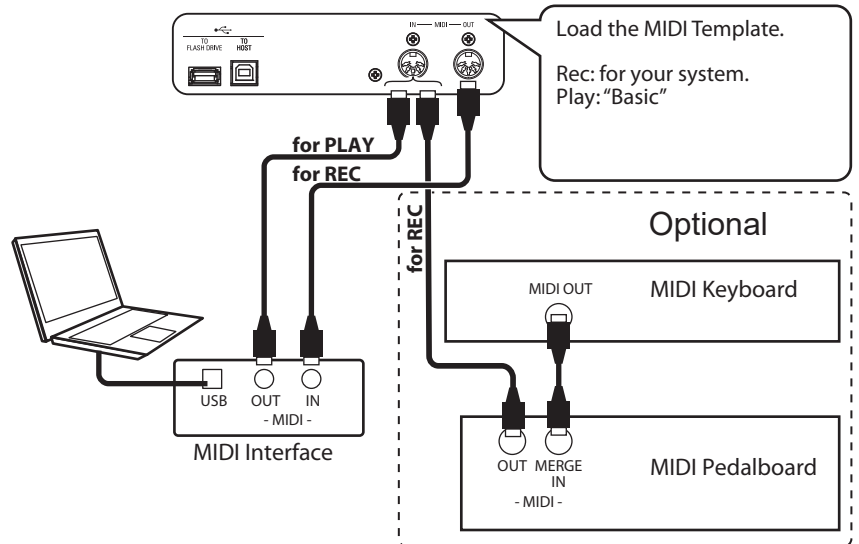

### PLAYBACK

1. Make the connections as shown in the figure above for Playback.
2. Select and Load the "Basic" MIDI Template.(see page 156).
3. Start playback of the sequence.

## RECORDING A PERFORMANCE VIA USB CABLE

The USB MIDI connection will allow you to Record and Play sequences with only one cable connection and no MIDI interface between the computer and the SK PRO as shown on the right.

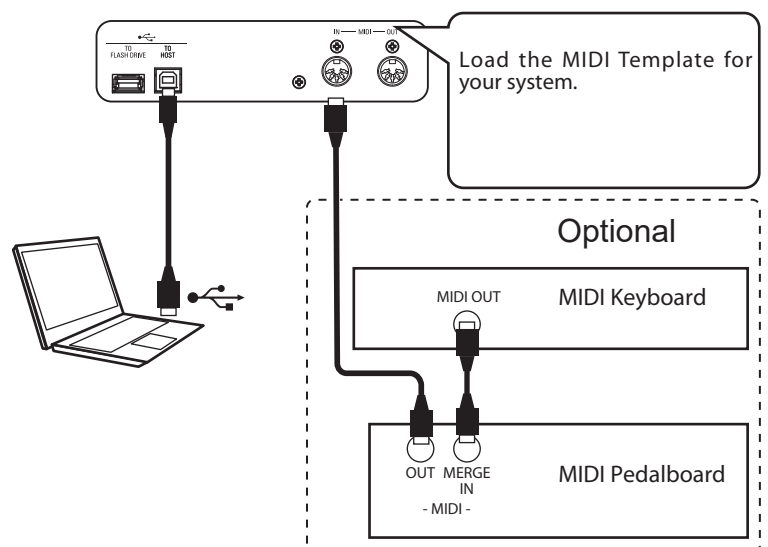



To control a MIDI sound module from the SK PRO using both a single keyboard and Expanded Keyboards, do the following:

## BASIC CONNECTIONS

### 1. CONNECT THE MIDI MODULE

Connect the MIDI OUT of the SK PRO to the MIDI IN of the MIDI Sound Module.

### 2. LOAD THE "EXZ..." MIDI TEMPLATE (P. 156)

This MIDI Template mutes the Keyboard Channels. If you want also to transmit MIDI data on the Keyboard Channels, you must turn them "ON" manually. See page 157 "MIDI Channels" for instructions on how to do this.

### 3. SET THE ZONES AND RECORD THE SETTINGS TO THE COMBINATION.

Please refer to page 78 "COMBINATION-EXTERNAL ZONES" for instructions on how to set Zones.

## SIMPLIFIED SETUP MODE

The setup mode described below allows you to transmit MIDI data without using the External Zones.

### 1. CONNECT A MIDI MODULE

Connect the MIDI OUT of the SK PRO to the MIDI IN of the MIDI sound module.

### 2. LOAD THE MIDI TEMPLATE FOR YOUR SYSTEM (P. 156).

Select the MIDI Template to Load (Sequence, Lower, Lower+Pedal, etc.) depending upon whether you are using Expanded Keyboards.

### 3. TURN OFF UNUSED MIDI MESSAGES (P. 156).

Turn MIDI messages for controlling Program Change, Drawbar Registration and NRPN "OFF." These messages are not used in this setup.

### 4. MATCH THE MIDI CHANNELS (P. 157).

Match the MIDI Channels between the Keyboard Channels of the SK PRO and the MIDI sound module.

**NOTE: Sounding Range and Program Change cannot be changed by a Combination in this simplified set up.**

**NOTE: If you are using only the ORGAN Voice Section in this mode, the MIDI velocity will be fixed at "100."**

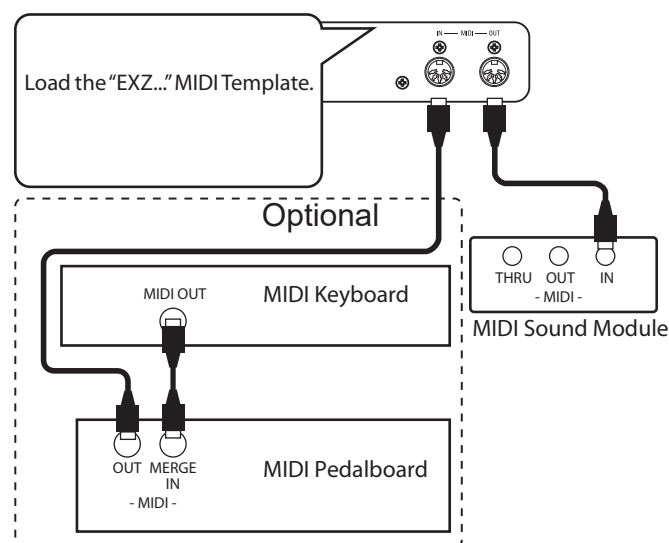

**tips** **SOUNDING POINT OF THE EXTERNAL ZONES**  
When keys are depressed, the sounding point of the External Zones is deeper than that of the ORGAN Section.

## RECORDING TO A SEQUENCER OR DAW USING THE MIDI PORTS

Load the “EXZ...” MIDI Template.  
 This MIDI Template mutes the Keyboard Channels. If you want also to transmit MIDI data on the Keyboard Channels, you must turn them “ON” manually. See page 157 “MIDI Channels” for instructions on how to do this.  
 Record both Keyboard Channels and External Zone Channels to the sequencer or DAW.

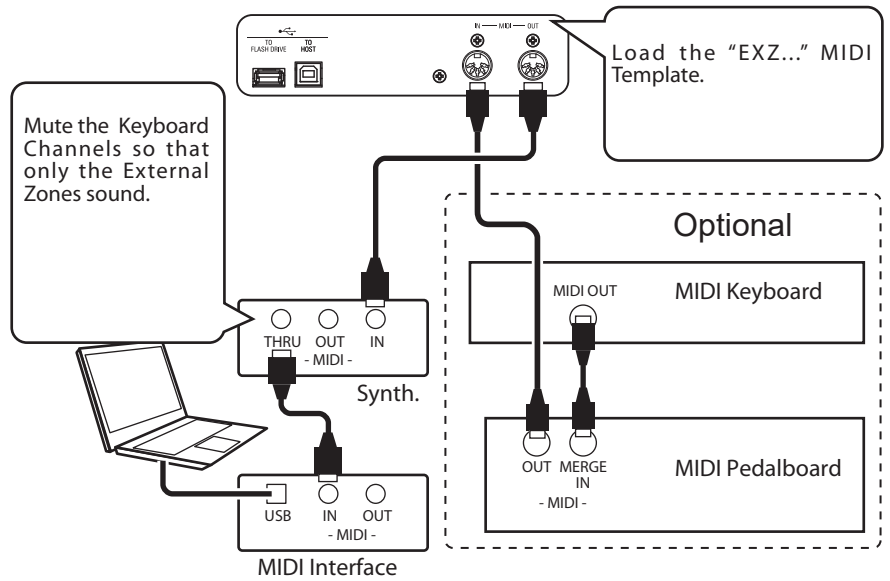

Set the Local Control of the SK PRO at “ON,” and Echo of the DAW at “OFF.”

## PLAY BACK THE PERFORMANCE

You can play back both Keyboard Channels and External Zone Channels from your sequencer or DAW.

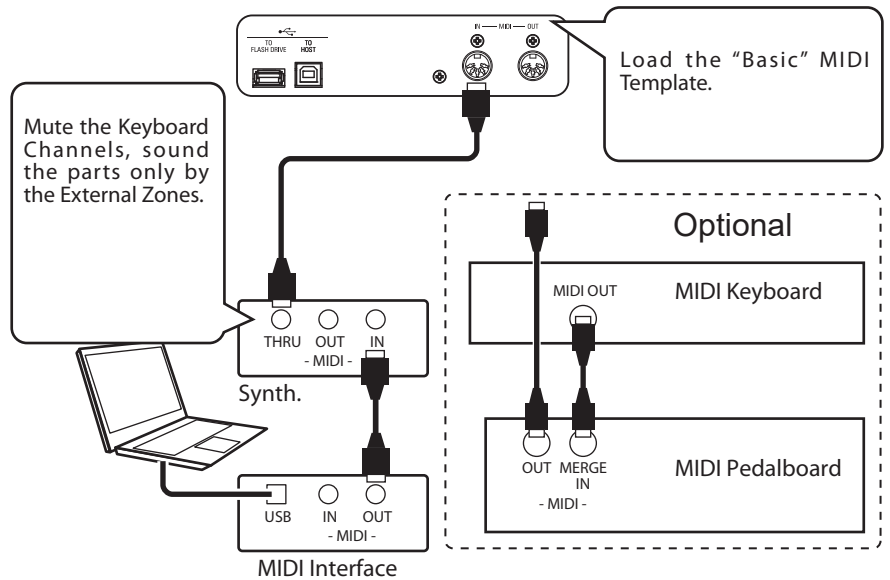

## USING USB MIDI

If you want to play the software synthesizer in a PC using both Keyboard Channels and External Zones, do the following:

1. Load the "EXZ..." MIDI Template.
2. Configure the Keyboard Channels for recording performance, transmit/receive, for UPPER, LOWER and PEDAL. This is necessary because the "EXZ.." MIDI Template turns the Keyboard Channels "OFF" automatically.
3. Set the Local Control at "ON."
4. Set the MIDI Echo of the sequencer or DAW at "ON" to sound the software synthesizer.
5. Record both Keyboard Channels and External Zone Channels to the sequencer or DAW.

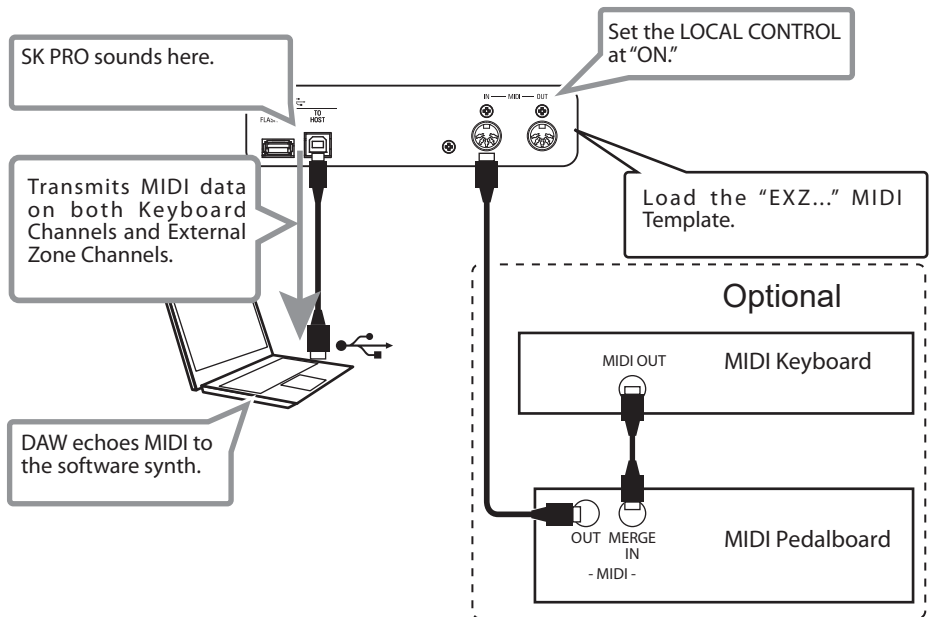

# MIDI FUNCTION MODE

This FUNCTION Mode allows you to adjust the basic MIDI Parameters as well as Send and Receive a MIDI Memory Dump.

## TO LOCATE THIS MODE:

[MENU/EXIT] - **SYSTEM** - **MIDI** - [ENTER]

### MIDI TEMPLATE

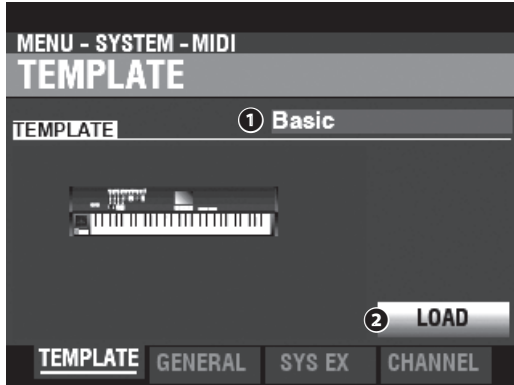

#### 1 MIDI TEMPLATE

This allows you to Load various pre-programmed MIDI settings. To Load a MIDI Template, select TEMPLATE, move the cursor to the ② [LOAD] icon and press the [ENTER] button.

**NOTE:** For a detailed listing of MIDI Templates, see "MIDI TEMPLATES" starting on page 178.

### GENERAL

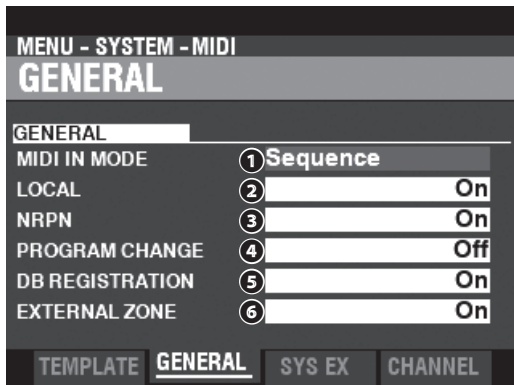

#### 1 MIDI IN

This allows you to select the function of the [MIDI IN] Port.

##### Sequence

Receives MIDI messages on UPPER, LOWER and PEDAL Parts on their MIDI Channels. It does not re-send.

##### Upper / Lower / Pedal

Use this Template to connect a MIDI keyboard as an (UPPER / LOWER / PEDAL) keyboard.

Received MIDI messages will sound the Sections allocated to the (UPPER / LOWER / PEDAL) keyboard ignoring the MIDI Channel, and will re-send to MIDI OUT and USB-MIDI.

##### Upper + Pedal / Lower + Pedal

Use this Template to connect two MIDI keyboards as (UPPER + PEDAL / LOWER + PEDAL) keyboards.

Received MIDI messages will sound the Sections allocated to (UPPER, PEDAL / LOWER, PEDAL) keyboards on the assigned MIDI Channels, and re-send to MIDI OUT and USB MIDI.

##### Organ Upper / Piano / Ensemble / Synth

A connected MIDI keyboard will play the ORGAN/PIANO/ENSEMBLE/MONO SYNTH) Sections. It does not re-send.

**NOTE:** The ORGAN Section will play from an UPPER Keyboard only.

**NOTE:** The SPLIT does not function when the MIDI IN mode is set at "Upper / Lower," "Lower + Pedal" or "Upper + Pedal."

#### 2 LOCAL CONTROL

Settings: Off, On

This allows you to turn Local Control "ON" or "OFF"

**On**..... The keyboard plays the internal sounds of the instrument.

**Off**..... The internal sounds of the SK PRO will not play from the keyboard. Use this setting for recording performance to an external sequencer with a MIDI Echo feature.

#### 3 NRPN

Settings: Off, On

This allows you to select whether **Non-Registered Parameter Numbers** (NRPN) will be sent or received.

**NOTE:** Please consult the Appendix for more information on NRPN codes used on the SK PRO.

#### 4 PROGRAM CHANGE

Settings: Off, On

This allows you to select whether to transmit and receive Program Change messages for Combination and External Zones.

#### 5 DRAWBAR REGISTRATION

Settings: Off, On

This allows you to select whether to transmit and receive Drawbar Registration.

#### 6 EXTERNAL ZONES

Settings: Off, On

This is a Master On/Off Parameter which allows you to enable or disable MIDI transmission of all External Zones in one operation.

## SYSTEM EXCLUSIVE MESSAGES

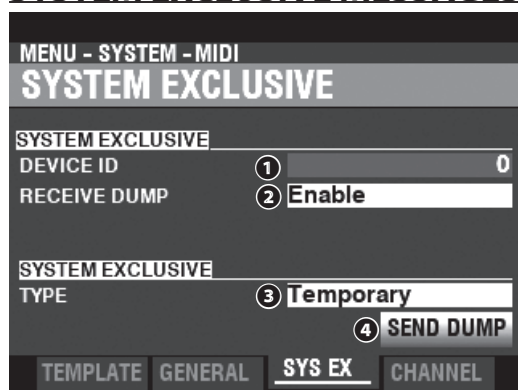

### ① DEVICE ID

**Setting Range:** 0 ~ 127

This allows you to set the Device ID which is used for System Exclusive Messages such as Memory Dump.

### ② RECEIVE DUMP

**Settings:** Disable, Enable

This allows you to Enable/Disable receiving of a Memory Dump. The SK PRO can transmit several settings as a Memory Dump in a single group. Select "Disable" if you want to prevent internal settings from being changed - for example, if you are playing back songs from an external sequencer or DAW.

### ③ SEND DUMP TYPE

**Settings:** Temporary, System

This allows you to adjust which contents will be transmitted by a Memory Dump.

#### Temporary

Transmits the current status of the Combination, ORGAN Section, MONO SYNTH Section.

**IMPORTANT:** If you are recording and playing back Sequences, transmit this data before touching any notes or controls so that the registrations for each Section will "match up."

#### System

Transmits the status of the System Parameters such as controller modes, MIDI Channels.

To send a Memory Dump, do the following:

1. Use the [DIRECTION] [▼] button to move the cursor to the ④[SEND DUMP] icon.
2. Press the [ENTER] button.

**NOTE:** If you want to Save the entire contents of the SK PRO save them as a Setup file instead of using a Memory Dump.

## MIDI CHANNELS

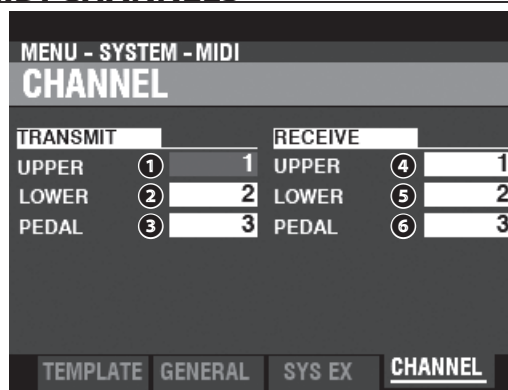

This allows you to adjust MIDI Channels for transmitting and receiving performance information for each Keyboard.

### ① TRANSMIT UPPER, LOWER, PEDAL

**Setting Range:** 1 ~ 16, Off

This allows you to select the transmitting (Sending) channels for the UPPER, LOWER and PEDAL.

**NOTE:** The UPPER Channel sends Controller information such as Pitch Bend, Expression Pedal or NRPN in addition to Note On/Note Off data.

**NOTE:** To avoid conflicting MIDI messages, set each TRANSMIT Channel and External Zone Channel at different values.

### ② RECEIVE UPPER, LOWER, PEDAL

**Setting Range:** 1 ~ 16, Off

This allows you to adjust the Receive channels for the UPPER, LOWER and PEDAL.

**NOTE:** The Parameters in this Mode are System Parameters. You must Record these Parameters if you want their settings to be remembered the next time the instrument is turned "ON." See page 141 for instructions on how to do this.

---

\*\*\*THIS PAGE INTENTIONALLY LEFT BLANK TO PRESERVE PAGE FORMATTING \*\*\*

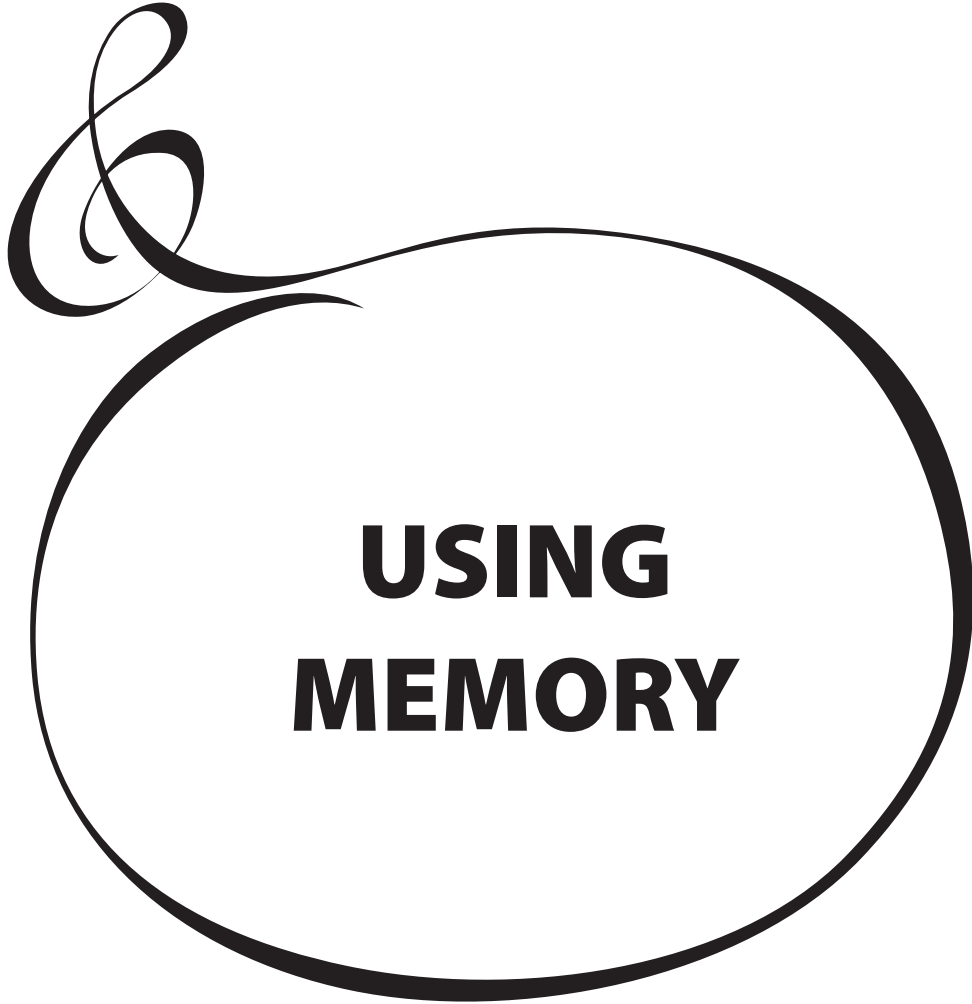

**USING  
MEMORY**

---

# USING MEMORY

You can Save various contents such as Patches, Custom Settings, etc., as files either to a USB Flash Drive or the Internal Memory of the SK PRO.

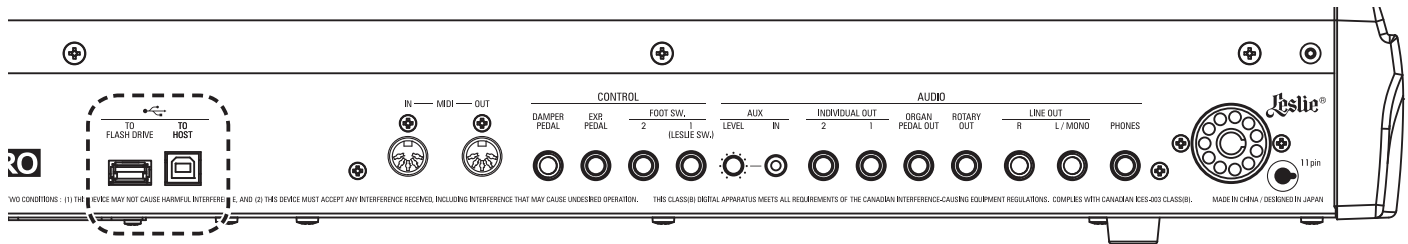

## WHAT YOU CAN DO WITH A USB FLASH DRIVE

- ◆ Save and Load Setups (see page 163).
- ◆ Save or Load a Patch or Custom Setting.
- ◆ Update the system software.

## ABOUT USB FLASH DRIVES

### COMPATIBLE USB FLASH DRIVES

There are various types of USB Flash Drives. Some require AC power at one of the pins on the USB interface. Because the SK PRO does not provide AC power at the USB Ports, these Drives are not compatible with the SK PRO. Generally, a Flash Drive formatted with MS-DOS FAT32 will work.

Consult our web site for more information about compatible USB Flash Drives.

In Europe: <http://www.hammond.eu>

In the US: <http://www.hammondorganco.com>

**NOTE: To confirm whether a USB Flash Drive is compatible, see MENU - SYSTEM - INFORMATION - IS ACTIVE - USB FLASH DRIVE (page 144).**

### USB CONNECTOR

1. Be sure to insert the USB Flash Drive correctly.
2. Do not remove the Flash Drive or turn the power "OFF" while accessing data to or from a USB Flash Drive.

### FOLDER STRUCTURE

When the USB Flash Drive is inserted, the following folders are automatically created on the drive.

The folder structure is same manner in the Internal Memory, too.

```

\hammond
  \skpro
    \custom
      \pipe
      \twheel
    \patch
      \organ
      \synth
      \voice
    \setup
      *.set
    \system
      *.sys
  
```

#### setup

Setup files are saved to this Folder

#### system

Copy software update files to this Folder.

**NOTE: There is an "affinity" between USB Flash Drives and the SK PRO, and not all Flash Drives are compatible. To confirm whether the SK PRO will read a particular Flash Drive, see MENU - SYSTEM - INFORMATION - IS ACTIVE - USB FLASH DRIVE.**

#### tips FILE NUMBER LIMIT

A Folder can contain up to 256 files.

#### tips FILE NAME EXTENSION

set	Setup File
opt	Organ Patch
vpt	Piano/Ensemble Patch
spt	Mono Synth Patch
ctw	Custom Tone Wheels
cpi	Custom Pipes



This FUNCTION Mode allows you to format a USB Flash Drive for use with the SK PRO.

**NOTE: Formatting a USB Flash Drive erases all data on the drive. Therefore, be sure to use either a new Drive or one which does not already have data you want to keep.**

## ① INSERT A USB FLASH DRIVE

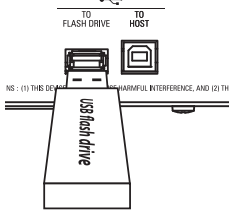

Turn the power to the SK PRO “ON” and insert a USB Flash Drive to the [TO FLASH DRIVE] Port. The message, “Confirming USB...” will display for approximately 1 second. Please wait for this message to disappear.

## ② LOCATE THE FORMAT PAGE

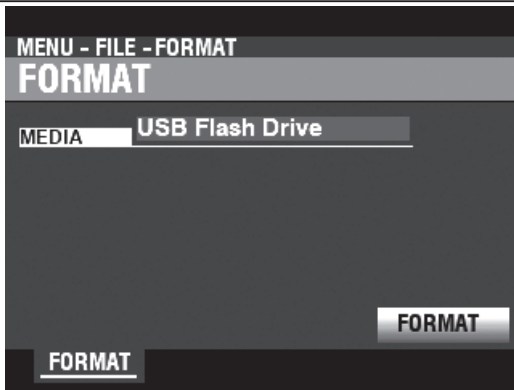

[MENU/EXIT] - FILE - FORMAT - [ENTER].

## ③ SELECT THE MEDIA

Use the [VALUE] knob to select “USB Flash Drive.”

## ④ FORMAT THE USB FLASH DRIVE

Use the [DIRECTION] [▼] button to move the cursor to the [FORMAT] icon and press the [ENTER] button. The message, “Formatting” will display and the formatting process begins. The time necessary to Format a USB Flash Drive may differ depending on the capacity of the Drive, but typically it will be approximately 1 or 2 seconds.

When the Format has finished, “Completed” will show in the display.

**NOTE: Do not turn the power “OFF” or remove the USB Flash Drive during the Formatting procedure.**

**NOTE: If you DO NOT wish to Format, press the [MENU/EXIT] or [PLAY] button instead of the [ENTER] button.**

### tips FORMATTING MEDIA

Under Step 3, you can select either “USB Flash Drive” or “Internal Memory” (explained later) as the media you wish to use.

The Format procedures between “USB Flash Drive” and “Internal Memory” are different. For “USB Flash Drive,” all data is deleted from the Drive and a File Structure is created. For “Internal Memory,” all files are deleted but no File Structure is generated.

## WHAT IS “USB MASS STORAGE?”

On the SK PRO, Setups can be saved to the **Internal Memory** of the instrument as well as to a USB Flash Drive.

Both the Internal Memory and a USB Flash Drive can Load and Save files; however, the Internal Memory can also access files from/to the host computer via USB cable. This is called “USB Mass Storage.”

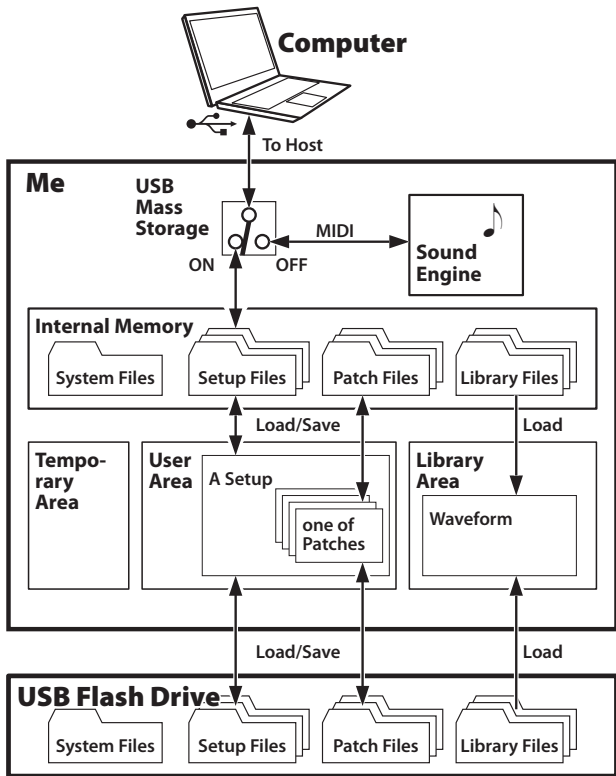

## SETTING USB MODE TO “HOST PORT”

Normally, the USB TO HOST Port sends and receives MIDI messages to or from a connected host computer. **USB Mass Storage** allows you to access files in the Internal Memory from a host computer (upper part of left figure).

**NOTE:** The USB TO HOST Port cannot communicate via MIDI while USB Mass Storage is in use.

### 1 LOCATE THE USB PAGE

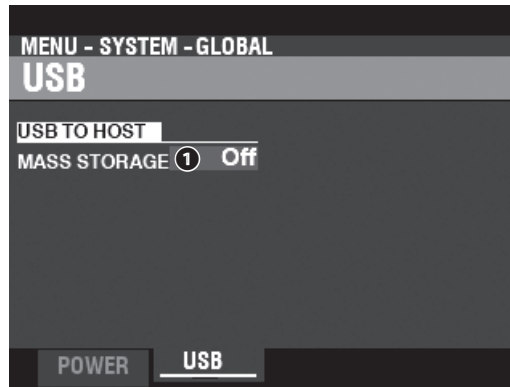

[MENU/EXIT] - SYSTEM - GLOBAL - [ENTER] - USB

### 2 SELECT THE FUNCTION

#### 1 MASS STORAGE

Use the [VALUE] knob to select the function of the USB TO HOST Port.

**Off** .....Sends/Receives MIDI.

**On**.....Connects the Internal Memory.

As explained elsewhere in this Manual, the SK PRO can be customized in a number of different ways - you can create Custom Settings, create your own Combinations and Patches, etc. After you have made your changes, you can save your edits as a Setup. In this way you can customize the instrument in several different ways and save each series of edits as a separate Setup.

The illustration below shows the data which can be contained in a Setup file.

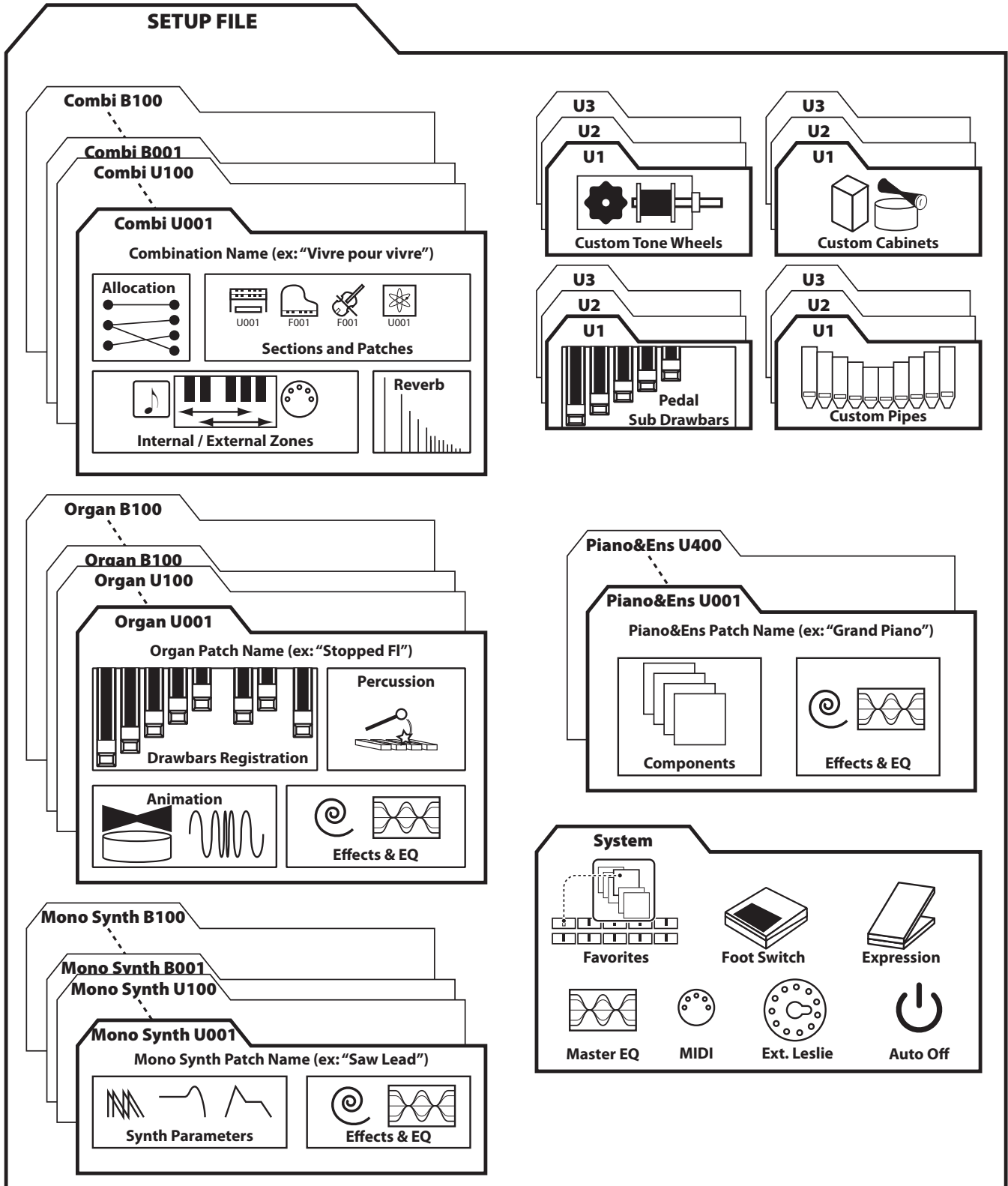

This FUNCTION Mode allows you to save contents in the SK PRO to a USB Flash Drive or Internal Memory.

## ① INSERT A USB FLASH DRIVE

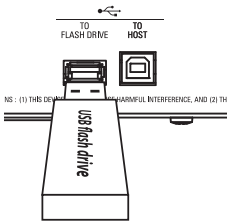

Insert a formatted USB Flash Drive into the [TO FLASH DRIVE] Port.

**NOTE:** If you are saving an item to the Internal Memory you may skip this step. "USB Flash Drive" will display to the right of "MEDIA" only if a USB Flash Drive has been inserted into the [TO FLASH DRIVE] Port.

## ② LOCATE THE "SAVE" PAGE

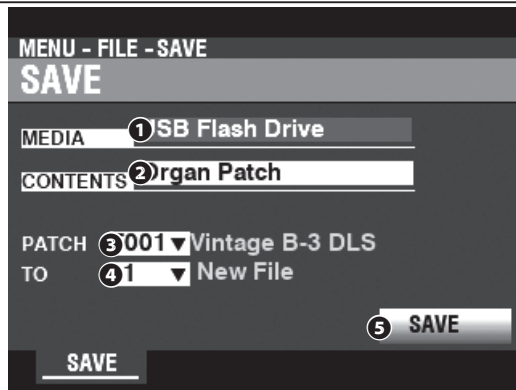

[MENU/EXIT] - FILE - SAVE - [ENTER].

## ③ SELECT THE ITEM TO SAVE

### ① MEDIA

Use the [VALUE] knob to select the media to which to Save.

**Internal Memory** ..... Internal Memory.

**USB Flash Drive** ..... USB Flash Drive.

### ② CONTENT

Use the [DIRECTION] [▼] button to move the cursor to [CONTENT] and use the [VALUE] knob to select the type of content to Save.

**Setup** ..... Setup file.

**Organ Patch** ..... Patch in the ORGAN Section.

**Piano/Ens Patch** ..... Patch in the PIANO/ENSEMBLE Section.

**Synth Patch** ..... Patch in the MONO SYNTH Section.

**Tone Wheel** ..... Custom Tone Wheel.

**Pipe** ..... Custom Pipe.

### ③ FILE

Use the [DIRECTION] [▼] button to move the cursor to [FILE] and use the [VALUE] knob to select the file to Save.

### ④ TO

Use the [DIRECTION] [▼] button to move the cursor to [TO] and use the [VALUE] knob to select the location to which to Save the selected file. Choose its number if you wish to overwrite the file, and choose "New File" for save as a new file.

### ④ SAVE

Use the [DIRECTION] [▼] button to move the cursor to [LOAD] and press the [ENTER] button.

## ④ NAME THE FILE

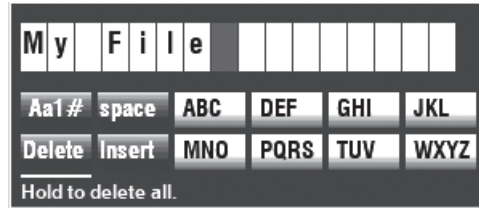

Enter the Name.

**[Aa1]** ..... Changes the character type.

**[1] - [10]** ..... Selects the highlighted character.

**[Insert]** ..... Inserts a space at the cursor.

**[Delete]** ..... Deletes a letter at the cursor.

**[VALUE]** ..... Changes the letter at the cursor.

After you have finished Naming your file, press the [ENTER] button. The message below will display for approximately 1 second:

**Saving...**

**NOTE:** Do not turn the power "OFF" while the above message is displaying.

**NOTE:** If you DO NOT wish to Save, press the [MENU/EXIT] button instead of the [ENTER] button.

## ⑤ RETURN TO THE PLAY MODE

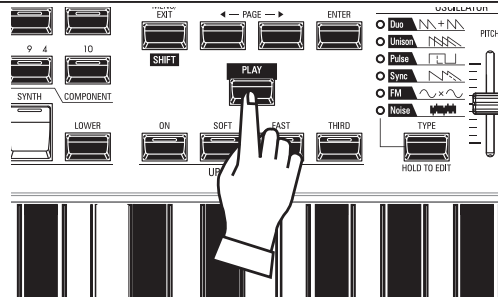

Press the [PLAY] button to return to the PLAY mode.

### tips SETUP NAMES

A Setup Name will appear on both Internal Memory and a USB Flash Drive. This is useful for ease of identification from an external computer. However, the SK PRO display will not show Setup Names. If a Setup is loaded, the Combinations and Patches contained in the Setup will show in the SK PRO display.

This FUNCTION Mode allows you to Load files saved to a USB Flash Drive or Internal Memory into the instrument.

## ① INSERT A USB FLASH DRIVE

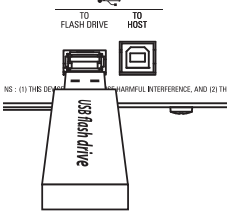

Insert a formatted USB Flash Drive into the [TO FLASH DRIVE] Port.

**NOTE:** If you are deleting an item from Internal Memory you may skip this step. "USB Flash Drive" will display to the right of "MEDIA" **only** if a USB Flash Drive has been inserted into the [TO FLASH DRIVE] Port.

## ② LOCATE THE "LOAD" PAGE

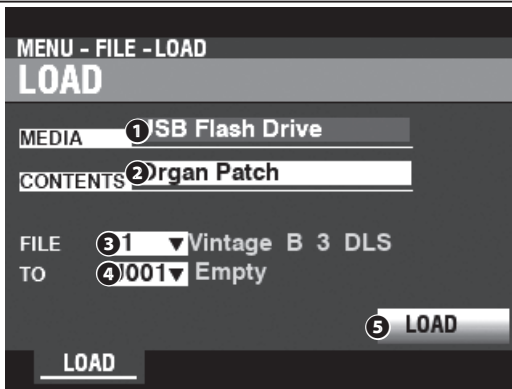

[MENU/EXIT] - FILE - LOAD - [ENTER]

## ③ SELECT THE ITEM TO LOAD

### ① MEDIA

Use the [VALUE] knob to select the media from which to Load.  
**Internal Memory** ..... Internal Memory.  
**USB Flash Drive**..... USB Flash Drive.

### ② CONTENT

Use the [DIRECTION] [▼] button to move the cursor to [CONTENT] and use the [VALUE] knob to select the type of content to Load.

- Setup**..... Setup file.
- Organ Patch**..... Patch in the ORGAN Section.
- Piano/Ens Patch**..... Patch in the PIANO/ENSEMBLE Section.
- Synth Patch**..... Patch in the MONO SYNTH Section.
- Tone Wheel**..... Custom Tone Wheel.
- Pipe**..... Custom Pipe.

### ③ FILE

Use the [DIRECTION] [▼] button to move the cursor to [FILE] and use the [VALUE] knob to select the file to Load.

### ④ TO

Use the [DIRECTION] [▼] button to move the cursor to [TO] and use the [VALUE] knob to select where to Load the file.

## ④ LOAD

Use the [DIRECTION] [▼] button to move the cursor to [LOAD] and press the [ENTER] button. The message below will display for approximately 1 second:

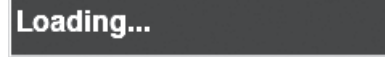

**NOTE:** Do not turn the power "OFF" while the above message is displaying.

**NOTE:** If you DO NOT wish to Load, press the [MENU/EXIT] or [PLAY] button instead of the [ENTER] button.

## ④ RETURN TO THE PLAY MODE

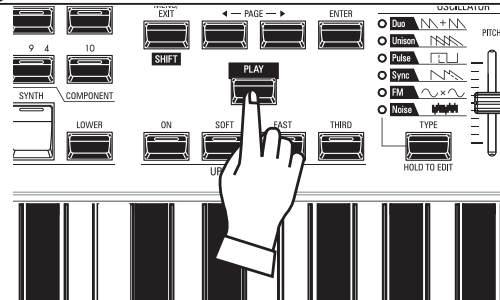

Press the [PLAY] button to return to the PLAY mode.

# DELETE

This FUNCTION Mode allows you to delete content previously saved either to a USB Flash memory or to Internal Memory.

## ① INSERT A USB FLASH DRIVE

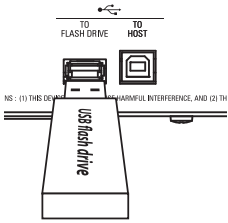

Insert a formatted USB Flash Drive into the [TO FLASH DRIVE] Port.

**NOTE:** If you are deleting an item from Internal Memory you may skip this step. "USB Flash Drive" will display to the right of "MEDIA" **only** if a USB Flash Drive has been inserted into the [TO FLASH DRIVE] Port.

## ② LOCATE THE "DELETE" PAGE

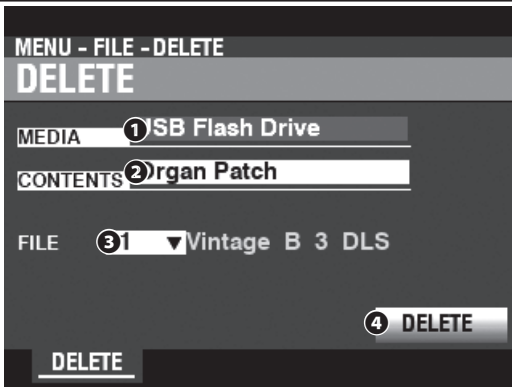

[MENU/EXIT] - FILE - DELETE - [ENTER]

## ③ SELECT THE ITEM TO DELETE

### ① MEDIA

Use the [VALUE] knob to select the media from which to Delete.

**Internal Memory** ..... Internal Memory.

**USB Flash Drive** ..... USB Flash Drive.

### ② CONTENT

Use the [DIRECTION] [▼] button to move the cursor to [CONTENTS] and use the [VALUE] knob to select the type of content to Delete.

**Setup** ..... Setup file.

**Organ Patch** ..... Patch in the ORGAN Section.

**Piano/Ens Patch** ..... Patch in the PIANO/ENSEMBLE Section.

**Synth Patch** ..... Patch in the MONO SYNTH Section.

**Tone Wheel** ..... Custom Tone Wheel.

**Pipe** ..... Custom Pipe.

### ③ FILE

Use the [DIRECTION] [▼] button to move the cursor to [FILE] and use the [VALUE] knob to select the file to Delete.

## ④ DELETE

Use the [DIRECTION] [▼] button to move the cursor to the DELETE icon and press the [ENTER] button. The message below will display for approximately 1 second:

Deleting...

**NOTE:** Do not turn the power "OFF" while the above message is displaying.

**NOTE:** If you DO NOT wish to Delete, press the [MENU/EXIT] or [PLAY] button instead of the [ENTER] button.

## ④ RETURN TO PLAY MODE

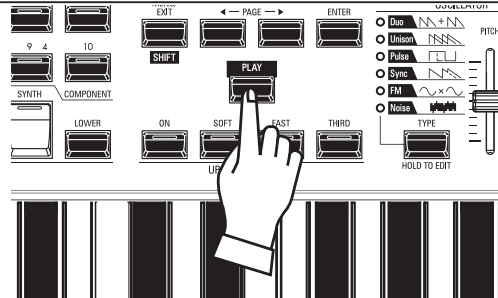

Press the [PLAY] button to return to the PLAY mode.



**TROUBLESHOOTING**

---

The SK PRO appears complicated; however, most troubles generally can be isolated by observing the operation of the various controls. This is illustrated by the following list of possible troubles, arranged according to their symptoms.

**NOTE: It is assumed that the entire instrument plays correctly with the exception of the symptoms mentioned.**

## TROUBLES

- ◆ Entire instrument fails to play.
  - ◆ The [MASTER VOLUME] or [VOLUME] controls for each Voice Section are set at minimum. Adjust the [VOLUME] knob(s).
  - ◆ The [ALLOCATE] buttons are “OFF” (LEDs not lit). Touch one of the [ALLOCATE] buttons “ON.”
  - ◆ MIDI Local Control is set to “OFF.” Turn the Local Control “ON.” See page 156 for instructions.
  - ◆ A Leslie Speaker Cabinet is connected. The sound of the Rotary Channel (Tone Wheel and Transistor Organs) does not appear at the [LINE OUT] or [PHONES] jacks when a Leslie Speaker is connected via the Leslie 11-pin socket. See page 131 for more information.
- ◆ One or more Voice Sections fail to play.
  - ◆ One or more of the [INDIVIDUAL OUT] jacks are in use. Set the AUDIO MODE at the desired usage. See page 131 for more information.
- ◆ Malfunction of buttons, keys, etc.
  - ◆ Turn the power to the instrument “OFF,” then turn it “ON” again. If this procedure is not successful,
    1. Turn the power to the instrument “OFF.”
    2. Press and Hold the [RECORD] Touch Button.
    3. While holding the [RECORD] Touch Button, turn the power to the instrument “ON.” All Parameters will return to their factory settings.
- ◆ Expression Pedal does not work.
  - ◆ The EXPRESSION - SOURCE Parameter is not set correctly. Set the Parameter for the function you desire. See page 133 for instructions.
  - ◆ The Expression Control in the Overdrive is set at “OD Only” or “Input.” Set the Parameter at “Exp.OD.” See page 111 for instructions.
  - ◆ The Source of the Multi Effects is set at “Exp.” Set the Parameter at one of the other settings. See page 108 for instructions.
  - ◆ The Expression for a Voice Section in a Combination is set at “OFF” Set the value at “ON.” See page 76 for instructions.
- ◆ Foot Switch does not work.
  - ◆ The Parameters for the Foot Switch are not set correctly. Check the Parameter settings for Foot Switch. See page 132 for instructions.
- ◆ Foot Switch effect works when the Foot Switch is released instead of depressed.
  - ◆ The Foot Switch Polarity was not detected. Connect the Foot Switch with the power to the SK PRO “OFF” and turn the power “ON” without depressing the Foot Switch (P. 132).
- ◆ [MENU/EXIT] and/or [RECORD] buttons do not work.
  - ◆ The display is Locked. Unlock the display (P. 72).
- ◆ File access stops between PC and USB Mass Storage.
  - ◆ Please wait for 2 minutes. The file access may restart.

## ERROR MESSAGES

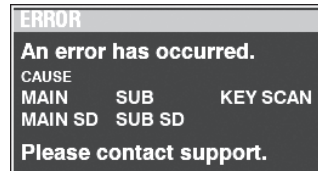

If the above message displays, please consult your authorized Hammond Dealer.

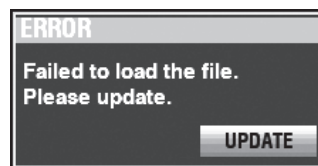

If the above message displays, one or more files necessary for operation of the instrument is missing. You can identify the missing file(s) with MENU - SYSTEM - INFORMATION. The missing file(s) will display “---” instead of a version number. Prepare a USB Flash Drive with the missing update files and complete the system update. Press the [ENTER] button with the [UPDATE] icon highlighted start the Update procedure.

**NOTE: You can ensure the installation of system files by pressing and holding the red [RECORD] button and pressing the [ENTER] button.**





**APPENDIX**

# FACTORY COMBINATIONS

Category	#	Name
Main Features	F001	Vintage B-3 DLS
	F002	Classic Gospel
	F003	ClasOrg Tutti
	F004	Console Riser
	F005	A. Piano D
	F006	Piano & Strings
	F007	A.Bass / A.Piano
	F008	Soul Line
	F009	Symphonic Ens
	F010	Macrocosmos
Tone Wheel Organ	F011	Vintage C-3 JOS
	F012	VintageB-3Squabl
	F013	Vintage B-3 McGr
	F014	VintageB-3Groove
	F015	X-66 Ballad
	F016	Edelweiss
	F017	Spanish
	F018	Old Days
	F019	Euro Bigband
	F020	Swedish Love
Transistor/Pipe Organ	F021	ClasOrg PrnChors
	F022	ClasOrg StgCelest
	F023	TheaOrg Ballad
	F024	TheaOrg StylDTrpt
	F025	TheaOrg Tibias
	F026	Purple
	F027	Emerson
	F028	Some Lovin'
	F029	Booker
	F030	Rock 1
Piano / Chro Perc / Keys	F031	Grand Piano Y-CF
	F032	Pop Piano CF
	F033	Upright Piano
	F034	Honky-Tonk Piano
	F035	Electric Grand
	F036	HP Old Time Prchd
	F037	EP Tine Mk1
	F038	Harpsichord Back
	F039	Clav.AC
	F040	Accordion LMMH
Strings / Choir	F041	Legato Strings
	F042	Section Strings
	F043	Synth Str.Bright
	F044	Synth Str.Mellow
	F045	Chamber Ensemble
	F046	Choir Aah
	F047	Violin
	F048	Sol. Strings
	F049	Taped Strings
	F050	Vocal & Str. Prchd

Category	#	Name
Wind	F051	Horn Rock Band
	F052	Trumpet Vib
	F053	Alto Sax Vib
	F054	Jazz Brass Prchd
	F055	Harm Chro Vib
	F056	Flute Vib
	F057	Pan Pipes
	F058	M12 Brazz
	F059	M12 Horn Ens
	F060	M12 Box Brass
Synth / Bass	F061	Fantasia Pad
	F062	Warm Pad
	F063	Phasing Pad
	F064	Oct Saw Ld
	F065	Sync Up&Down Ld
	F066	Trancy Ld
	F067	Acoustic Bass
	F068	Finger Bass Jz
	F069	Big Funk
	F070	Timpani Roll/Hit
Famous Tunes	F071	Lady Green Eyes
	F072	Do You Know
	F073	Vibrating Good
	F074	Satin White
	F075	Craft Work
	F076	Jan's Hammer
	F077	Wonder 4 Th City
	F078	Woven Dream
	F079	Your Rhythm Mix
	F080	Jumped!
Famous Tunes	F081	Vienna
	F082	Vienna Bridge
	F083	99 Nena
	F084	Pop Muzik
	F085	Electric Friends
	F086	Don't You Go
	F087	Follow Your & Me
	F088	Manfred's Light
	F089	Green Monday
	F090	Ph. D I won't
Famous Tunes	F091	I'm Ready
	F092	Won't Get Fooled
	F093	Blinding Lights
	F094	Lovefool
	F095	California Girl
	F096	Hot Stuff
	F097	Galway Girl
	F098	Last Christmas
	F099	Treasure
	F100	Zankoku Tenshi

# ORGAN PATCHES

Patch #	Category	Name
F001	Jazz	Vintage B-3 DLS
F002	Jazz	Vintage C-3 JOS
F003	Jazz	VintageB-3Squabl
F004	Jazz	VintageB-3Groove
F005	Jazz	Vintage B-3 McG
F006	Jazz	Vintage B-3+Echo
F007	Jazz	Organ Ballad
F008	Jazz	Jerry C
F009	Jazz	Lee Bee
F010	Jazz	Full Spin
F011	Gospel	Classic Gospel
F012	Gospel	Slow Gospel
F013	Gospel	ContmpraryGospel
F014	Gospel	Shout Gospel
F015	Gospel	Quiet Praise
F016	Gospel	Reflective Praise
F017	Gospel	Dramatic Praise
F018	Gospel	Total Praise
F019	Gospel	Meditasion
F020	Gospel	Full Gospel
F021	Classic Pipe	Principal Chorus
F022	Classic Pipe	Flute Chorus
F023	Classic Pipe	Gamba Celeste
F024	Classic Pipe	Baroque
F025	Classic Pipe	Stopped Flutes
F026	Classic Pipe	Diapasons 8'&4'
F027	Classic Pipe	Bourdon 16'&Prin2'
F028	Classic Pipe	Flutes w/Trem
F029	Classic Pipe	Oboe Solo
F030	Classic Pipe	Sforzando
F031	Theatre Pipe	Tibias & Vox
F032	Theatre Pipe	Tibia 8'&4'
F033	Theatre Pipe	StylDTrumprtSolo
F034	Theatre Pipe	Oboe 8'&Tibia 4'
F035	Theatre Pipe	Tibias 16'&4'
F036	Theatre Pipe	BrassTrumpetSolo
F037	Theatre Pipe	Strings&Voxes
F038	Theatre Pipe	Tibia 16'8'2'&Vox
F039	Theatre Pipe	FullTibias&Voxes
F040	Theatre Pipe	FullComb+Posthrn
F041	Rock	Purple
F042	Rock	Emerson
F043	Rock	Some Lovin'
F044	Rock	Booker
F045	Rock	Rock 1
F046	Rock	Rock 2
F047	Rock	Rock 3
F048	Rock	Full 1
F049	Rock	Full 2
F050	Rock	Full Overdrive

Patch #	Category	Name
F051	Tibia	DB Tibia 8'&4'
F052	Tibia	DB Tibia 8'&2'
F053	Tibia	DB Tibia & Vox
F054	Tibia	DB Tibia 8'4'& 2'
F055	Tibia	DB Tibia 16'&8'
F056	Tibia	DB Tibia 16 &4'
F057	Tibia	DB Tibia 16'8'4'
F058	Tibia	DB Tibia 1684&2'
F059	Tibia	DB Tibia 168421'
F060	Tibia	DB Full Tibia
F061	Lo & Hi	Lo & Hi 1
F062	Lo & Hi	Lo & Hi 2
F063	Lo & Hi	Lo & Hi 3
F064	Lo & Hi	Odd Harmonic
F065	Lo & Hi	Pop Solo
F066	Lo & Hi	Perc 16'&4'
F067	Lo & Hi	Solo 16'&2'
F068	Lo & Hi	Cute Solo
F069	Lo & Hi	Eddie's Wind
F070	Lo & Hi	Full Hammond
F071	Pop	Sylvia
F072	Pop	Lady
F073	Pop	Yeh Yeh
F074	Pop	Season Time
F075	Pop	On a Clear Day
F076	Pop	Twee motten
F077	Pop	Toccata Live
F078	Pop	Je t'aime moi
F079	Pop	Early Bird
F080	Pop	Bluesette
F081	Vx	Vx Mellow
F082	Vx	Vx Bright
F083	Vx	Vx Mixture
F084	Farf	Farf Flute
F085	Farf	Farf Brass
F086	Farf	Farf Reeds
F087	Farf	Farf Strings
F088	Farf	Farf Full
F089	Ace	Ace Flute
F090	Ace	Ace Reeds
F091	Ace	Ace Strings
F092	Contemp	Summer Samba
F093	Contemp	Dancing Days
F094	Contemp	Pipe Mixture
F095	Contemp	California Girl
F096	Contemp	Won't Get Fooled
F097	TW Basic	Master Comp
F098	TW Basic	Sweet Carpet
F099	TW Basic	DB Reed
F100	TW Basic	DB Diapason

## PIANO/ENSEMBLE PATCHES

Patch #	Category	Name
F001	A. Piano	Grand Piano Y-CF
F002	A. Piano	Grand Piano StwD
F003	A. Piano	GP Y & LegatoStr
F004	A. Piano	GP S & LegatoStr
F005	A. Piano	GP Y & Warm Pad
F006	A. Piano	GP S & Warm Pad
F007	A. Piano	Upright Piano
F008	A. Piano	Honky-Tonk Piano
F009	A. Piano	Pop Piano CF
F010	A. Piano	HP OldTime PrChd
F011	A. Piano	Electric Grand
F012	A. Piano	Electric Grand Comp
F013	A. Piano	ElecGrand & Pad
F014	A. Piano	Toy Plano Kw1
F015	A. Piano	Toy Piano Kwi Pan
F016	A. Piano	Toy Piano Sch
F017	A. Piano	Toy Piano Sch MoDly
F018	A. Piano	Toy Piano S&K
F019	A. Piano	Slow Atk Y-CF
F020	A. Piano	Slow Atk StwD
F021	A. Piano	Stadium Grand
F022	A. Piano	Rehearsal Room
F023	A. Piano	Compressed Grand
F024	E. Piano	EP Tine MkI
F025	E. Piano	EP Tine MkI Pan
F026	E. Piano	EP Tine MkI Phase
F027	E. Piano	EP Tine MkI Chorus
F028	E. Piano	EP Tine MkI OD
F029	E. Piano	EP Tine MkII
F030	E. Piano	EP Tine MkII Pan
F031	E. Piano	EP Tine MkII Phase
F032	E. Piano	EP Tine MkII Chorus
F033	E. Piano	Tine MkII OD
F034	E. Piano	EP Reed 200A
F035	E. Piano	EP Reed 200A Trem
F036	E. Piano	EP Reed 200A Phase
F037	E. Piano	EP Reed 200A OD
F038	E. Piano	EP FM
F039	E. Piano	EP FM Pan
F040	E. Piano	EP FM Phase
F041	E. Piano	EP FM Chorus
F042	E. Piano	EP FM + GrandPno
F043	E. Piano	80's Layer Piano
F044	E. Piano	Reed Pno+FM Pno
F045	E. Piano	Space Mk II + FM
F046	E. Piano	Mk I&LegatoStrings
F047	E. Piano	Compressed Mk1
F048	E. Piano	GW Tine Mk2
F049	Harpsichord	Harpsi Back
F050	Harpsichord	Harpsi Back Cpl
F051	Harpsichord	Harpsi Front
F052	Harpsichord	Harpsi Buff
F053	Harpsichord	Harpsi PCD

Patch #	Category	Name
F054	Harpsichord	Harpsi & Recorder
F055	Harpsichord	Harpsi OD
F056	Clav.	Clav. AC
F057	Clav.	Clav. AD
F058	Clav.	Clav. BC
F059	Clav.	Clav. BD
F060	Clav.	Clav. AC Wah
F061	Clav.	Clav. AD Wah
F062	Clav.	Clav. BC Wah
F063	Clav.	Clav. BD Wah
F064	Clav.	Clav. AC PdWah
F065	Clav.	Clav. AD PdWah
F066	Clav.	Clav. BC PdWah
F067	Clav.	Clav. BD PdWah
F068	Clav.	Clav. RealLove
F069	Clav.	Pulse Clav.
F070	Clav.	Clav Hard OD
F071	Clav.	Clav Bass
F072	Clav.	Clav&Reed 200
F073	ChroPerc	Xylophone
F074	ChroPerc	Mixing Bowl
F075	ChroPerc	Xylo Duo Prchd
F076	ChroPerc	Xylo 4tet Prchd
F077	ChroPerc	Marimba Normal
F078	ChroPerc	Marimba Trem
F079	ChroPerc	Marimba Sustain
F080	ChroPerc	MarimbaDuo Prchd
F081	ChroPerc	Marimba4tet Prchd
F082	ChroPerc	Xylo + Marimba
F083	ChroPerc	Glockenspiel
F084	ChroPerc	GlockenspielX-66
F085	ChroPerc	Vibraphone
F086	ChroPerc	Tubular Bells
F087	ChroPerc	Tubular Bells FM
F088	ChroPerc	Tubular Bells TW
F089	ChroPerc	Church Bells
F090	ChroPerc	Music Box
F091	ChroPerc	Tonechimes
F092	ChroPerc	TonechimesDamped
F093	ChroPerc	Hand Bells
F094	ChroPerc	HandBells Damped
F095	ChroPerc	TnchmsHymn Prchd
F096	ChroPerc	TchmHrmChm Prchd
F097	ChroPerc	HnBl&Tchm4tet Prchd
F098	ChroPerc	Wine Glass
F099	ChroPerc	WG Lawrence
F100	ChroPerc	Digi Bell 1
F101	ChroPerc	Digi Bell 2
F102	ChroPerc	Rather Be Prchd
F103	ChroPerc	Cathedral Chimes
F104	ChroPerc	Marimba + Glock
F105	ChroPerc	Organ Harp
F106	ChroPerc	Vibraharp

Patch #	Category	Name
F107	Guitar	Nylon Guitar
F108	Guitar	Steel Guitar
F109	Guitar	Nylon&Steel Gtrs
F110	Guitar	StelGtDuo Prchd
F111	Guitar	12-String Guitar
F112	Guitar	Jazz Guitar
F113	Guitar	Jazz Guitar Oct
F114	Guitar	PedalSteelGuitar
F115	Guitar	Orchestral Harp
F116	Guitar	OH WholeTone C
F117	Guitar	OH WholeTone F
F118	Guitar	PizzicatoStrings
F119	Guitar	PizzStr + Glock
F120	Guitar	NylonGtr+Tine EP
F121	Guitar	SteelGtr+Tine EP
F122	Ethnic	Dulcimer
F123	Ethnic	Sitar
F124	Ethnic	Banjo
F125	Ethnic	Koto
F126	Ethnic	Pan Pipes
F127	Ethnic	SteelGtr&Dulcimer
F128	Ethnic	PanPipe&Recorder
F129	Ethnic	Koto & Pan Pipes
F130	SFX	Zap
F131	SFX	Rain
F132	SFX	Telephone
F133	SFX	Flanging Noise
F134	SFX	Burst Noise
F135	SFX	Sine Prchd
F136	SFX	WhiteNoisePedWah
F137	SFX	Sine RingMod
F138	Wind	Horn Rock Band
F139	Wind	Unison Sax
F140	Wind	Ceddin Deden
F141	Wind	M12 Box Brass
F142	Wind	M12 Brazz
F143	Wind	M12 Horn Ens
F144	Wind	SynBrs Bird Low
F145	Wind	SynBrs Bird Oct
F146	Wind	SynBrs GX
F147	Wind	Flute Prchd
F148	Wind	BigBandSax Prchd
F149	Wind	BigBand Prchd
F150	Wind	Unison Brs FD
F151	Wind	Unison Brs GUp
F152	Wind	Quartet 1 Prchd
F153	Wind	Quartet 2 Prchd
F154	Wind	Jazz Brass Prchd
F155	Wind	MutedCombo1Prchd
F156	Wind	MutedCombo2Prchd
F157	Wind	Trumpet Str
F158	Wind	Trumpet Vib
F159	Wind	Trumpet Section

Patch #	Category	Name
F160	Wind	Trumpet Muted
F161	Wind	Trombone Str
F162	Wind	Trombone Muted
F163	Wind	Flute Vib
F164	Wind	Taped Flute
F165	Wind	Recorder
F166	Wind	Synth Whistle
F167	Wind	Alto Sax Str
F168	Wind	Alto Sax Vib
F169	Wind	Tenor Sax Str
F170	Wind	Tenor Sax Vib
F171	Wind	Bari Sax Str
F172	Wind	Tp & Tb Str
F173	Wind	Tp & Tb Vib
F174	Wind	Tp & Tb Mute
F175	Wind	Ed's OB Brazz
F176	Wind	Ray's Flute
F177	Wind	SaxQuartet Prchd
F178	Strings	Legato Strings
F179	Strings	Legato Strgs Oct
F180	Strings	LgatoSt Op Prchd
F181	Strings	Section Strings
F182	Strings	Section Str Oct
F183	Strings	SectStr Op Prchd
F184	Strings	Synth Str.Bright
F185	Strings	Synth Str.Mellow
F186	Strings	Sol. Strings
F187	Strings	Sol. Strings Oct
F188	Strings	Taped Strings
F189	Strings	Glass Harp
F190	Strings	Violin
F191	Strings	TapedChoir&Strings
F192	Strings	Synth Stringz
F193	Strings	TapedStrg&SynStr
F194	Strings	TapedStrg&SecStr
F195	Strings	SectStrings&Violin
F196	Choir	Choir Aah
F197	Choir	Choir Doo
F198	Choir	Vocal
F199	Choir	Vocal&Strg Prchd
F200	Choir	Vcal&Choir Prchd
F201	Choir	Taped Choir
F202	Choir	TapedChoir Prchd
F203	Choir	TapedChoir&Flute
F204	Choir	Space Choir
F205	Synth Pad	Fantasia Pad
F206	Synth Pad	Harp Pad
F207	Synth Pad	Warm Pad
F208	Synth Pad	Choir Pad
F209	Synth Pad	Soundtrack
F210	Synth Pad	Wind Bell
F211	Synth Pad	PWM Pad

## 174 PIANO/ENSEMBLE PATCHES- continued

Patch #	Category	Name
F212	Synth Pad	Sweep Pad
F213	Synth Pad	Sample&Hold Pad
F214	Synth Pad	Phasing Pad
F215	Synth Pad	Chime Pad
F216	Synth Pad	Rattle Pad
F217	Synth Pad	2.2 Pad
F218	Synth Pad	Shimmer Pad
F219	Synth Pad	It's A Miracle
F220	Synth Pad	Zan-Te Pong
F221	Synth Pad	Fantasia&Strings
F222	Synth Pad	SynthPad&M12Brss
F223	Synth Pad	SynthPad&TapedSt
F224	Bass	Acoustic Bass
F225	Bass	AcouBass&RideCym
F226	Bass	AcouBass & Brush
F227	Bass	AcouBass & Drums
F228	Bass	Finger Bass Jz
F229	Bass	Finger Bass Pr
F230	Bass	Pick Bass Jz
F231	Bass	Pick Bass Jz OD
F232	Bass	Pick Bass Pr
F233	Bass	Pick Bass Pr OD
F234	Bass	Slap Bass
F235	Bass	Slap Bass Delay
F236	Bass	FM Bass
F237	Bass	Timpani Normal
F238	Bass	Timpani Roll
F239	Bass	Legato Strg Bass
F240	Bass	Symphonic Bass
F241	Bass	ElecPiano Bass
F242	Bass	FingBas+HarmStacc
F243	Bass	AcouBass & Trbn
F244	Bass	Pick Bass Sp1
F245	Bass	Pick Bass&Pulse66
F246	Bass	ElecPiano Bass Vel
F247	Bass	AcousticBass+FM
F248	Synth Lead	Square Ld Bright
F249	Synth Lead	Square Ld Mellow
F250	Synth Lead	Saw Ld
F251	Synth Lead	Fifth Ld
F252	Synth Lead	Sync Ld U&D
F253	Synth Lead	Sync Ld D
F254	Synth Lead	Noise Ld
F255	Synth Lead	OPZ LFO Ld
F256	Synth Lead	Lucy Arp
F257	Synth Lead	Gimme^3 Ld
F258	Synth Lead	Tel Line Ld
F259	Synth Lead	Hot Stuff Ld
F260	Synth Lead	Take On Ld
F261	Synth Lead	B.Light Ld
F262	Synth Lead	Unison Ld
F263	Synth Lead	UnisonNoise Ld

Patch #	Category	Name
F264	Synth Lead	Chocolate Seq
F265	Synth Lead	Puttin'RitzPrchd
F266	Synth Lead	Synth Ralf
F267	Synth Lead	Pulse75&Alto Sax
F268	Synth Lead	Saw & M12 Brass
F269	Synth Lead	Pulse80+Violin
F270	Synth Lead	SquareDuet Prchd
F271	Free Reed	Accordion M
F272	Free Reed	Accordion LM
F273	Free Reed	Accordion LMH
F274	Free Reed	Accordion LMMH
F275	Free Reed	Accordion MMM
F276	Free Reed	Reed Organ
F277	Free Reed	Reed Organ Oct
F278	Free Reed	Harm Single
F279	Free Reed	Harm Chro Norm
F280	Free Reed	Harm Chro Vib
F281	Free Reed	Harm Chro OD
F282	Free Reed	Harm FM
F283	Free Reed	Melodion S-32
F284	Free Reed	Melodion PRO-44
F285	Free Reed	Melodion M-37
F286	Free Reed	Melodion M-37Twin
F287	Free Reed	MelodionM37ODWah
F288	Free Reed	Melodion B-24
F289	Free Reed	Melodion 2 Prchd
F290	Free Reed	Melodion 3 Prchd
F291	Free Reed	Melodion 4 Prchd
F292	Free Reed	MelodnP44+HarChr
F293	Free Reed	MelodnB24+Marimba
F294	Free Reed	HarChrVb+AltoSax
F295	Percussion	Ride Cymbal
F296	Percussion	Brush Snare Drum
F297	Percussion	Wind Chime
F298	Percussion	Tone Tang
F299	Percussion	OH WITnC&WindChm
F300	Percussion	OH WITnF&WindChm

### tips WHAT IS "ProChord?"

**ProChord™** is a unique feature of certain Hammond instruments, including the SK PRO, which allows you to play professional right-hand harmony while playing a single-note melody. The harmonization applied to the melody is determined by which chord is played by the left hand.

Patch #	Name
F001	Sine Lead
F002	Saw Lead
F003	Fat Saw w/Chorus
F004	Wild Chorus
F005	SW Synth #1
F006	Staircase 4dg
F007	FM Flute
F008	LeadSqu w/Chor
F009	Synth Trombone
F010	Quartersteps
F011	B-3 Perc Synth
F012	Tuned White Noise
F013	Basic Syn Bass
F014	PHAT Bass
F015	Ed's OB Bass
F016	Chirp Bass
F017	Melodic Solo 1
F018	Perc. Bass
F019	Florian Bass
F020	Hard Solo
F021	Autobahn
F022	Oxygene
F023	Magnetic
F024	Electric Friends
F025	Don't You Go
F026	Blue Monday
F027	Get Enough
F028	Tainted Love
F029	Sweet Dreams
F030	West End Girls
F031	99 Luftballons
F032	You Want Me
F033	Vienna
F034	Pop Muzik Perc
F035	Don't Go Bass
F036	Noise 1
F037	Noise 2
F038	Special PF
F039	Special VG
F040	Aliens
F041	Bright Brass
F042	MG Lead
F043	F. P. Cress.
F044	Spacious Saw Ld
F045	Funny Ld
F046	Oct Saw Ld
F047	Oct Sqr Ld
F048	4th Saw Ld
F049	4th Sqr Ld
F050	I'm Ready

Patch #	Name
F051	Lucky Man
F052	Takarajima
F053	Gut Daze
F054	Sweep Bass
F055	Reso Sweep Bass
F056	Oct. Sweep Bass
F057	Arpie Bass
F058	Chameleon Bass
F059	Rock With You Ld
F060	Beep Ld
F061	Belly Ld
F062	Over Mod Ld
F063	Material Ld
F064	Cool Bass
F065	Metallic Bass
F066	FM Horn
F067	FM Reed
F068	Square Ld
F069	Sqr Alt Oct Ld
F070	Popcorn Ld
F071	Pulse Ld
F072	PWM Tri Ld
F073	PWM S/H Ld
F074	PWM Frac Ld
F075	Square Bass
F076	Sync Up Ld
F077	Sync Down Ld
F078	Sync Up&Down Ld
F079	Sync S/H Ld
F080	Sync Frac Ld
F081	Trancy Ld
F082	Out Of Tune Ld
F083	Sweep Trancy Ld
F084	Sqr With Saw Ld
F085	Saw With Sqr Ld
F086	Noise Ld
F087	Chip Perc.
F088	Falling Noise
F089	Upward Noise
F090	Wind
F091	Seashore
F092	Pitch S/H
F093	Glass Crash
F094	Launch
F095	Percussive Saw
F096	Oct&Vibrato Ld
F097	Glass Crash
F098	Unison Bass
F099	Sqr+Saw Oct Bass
F100	Big Drift

# WAVEFORM LIST

## PIANO/ENSEMBLE

	Category		Name
1	A. Piano	1	GrandPf Yam CF3
		2	GrandPf Strw D Str
		3	GndPf StwDSt Rel
		4	UpUf Regular
		5	UpUf Honky
		6	Electric Grand
		7	Toy Pf Kaw
		8	Toy Pf Kaw Rel
		9	Toy Pf Sch
		10	Toy Pf Sch Rel
		11	Pop Piano CF
2	E. Piano	1	EP Tine Mk1 On
		2	EP Tine Mk1 Off
		3	EP Tine Mk2 On
		4	EP Reed 200A
		5	E.Piano FM
		6	E.Piano FM Cho
		7	EP Tine Mk1 Soft
		8	EP Reed Soft
3	Harpsichord	1	Hpsichrd Back
		2	Hpsichrd Front
		3	Hpsichrd Buff
		4	Hpsi Off
4	Clav	1	Clav AC
		2	Clav AD
		3	Clav BC
		4	Clav BD
		5	Clav Off
5	Chro. Perc.	1	Xylophone YX Norm
		2	Marimba YM Norm
		3	Marimba YM Trem
		4	Glockenspiel
		5	Glock. X-66
		6	Vibraphone YV
		7	Tublar Bells
		8	Tub Bells FM
		9	Tub Bells TW
		10	Church Bell
		11	Wine Glass
		12	Tonechimes
		13	Hand Bells
		14	Syn. Celesta
		15	Digi Bell 1
		16	Digi Bell 2
		17	Crystal
		18	Music Box
6	Guitar	1	Nylon-Str Gt.
		2	Steel-Str Gt.
		3	12Str Gt. A
		4	12Str Gt. B
		5	Jazz Gt.
		6	Pedal Steel Gt
		7	Orch Harp
		8	OH Whole Tone C
		9	OH Whole Tone F
		10	Pizzicato Str.
7	Ethnic	1	Dulcimer
		2	Sitar
		3	Tanpura
		4	Banjo
		5	Soh
		6	Pan Pipes
8	SFX	1	Sine
		2	White Noise
		3	Rain
		4	TelephoneRingSus
		5	TelephoneRingRel
		6	E. Driver Sus

	Category		Name
		7	E. Driver Rel
9	Wind	1	Trumpet Str
		2	Trumpet Vib
		3	Trumpet Muted
		4	Tp. Fall Sus
		5	Tp. Fall Atk
		6	Tp. Grs Up Sus
		7	Trumpet Sect.
		8	Trombone Str
		9	Trombone Muted
		10	Tb. Fall Sus
		11	Tb. Fall Atk
		12	Flute Str
		13	Flute Vib
		14	Flute Atk
		15	Alto Sax Str
		16	Alto Sax Vib
		17	Tenor Sax Str
		18	Tenor Sax Vib
		19	Bari Sax Str
		20	Recorder
		21	Flute Taped
		22	M12 Box Brass 1
		23	M12 Box Brass 2
		24	M12 Brazz 1
		25	M12 Brazz 2
		26	M12 Horn Ens 1
		27	M12 Horn Ens 2
10	Strings	1	Str. Legato
		2	Str. Section
		3	Synth Str. Mlw
		4	Synth Str. Bri
		5	Sol. Str.
		6	Violins Taped
		7	Violin
		8	Glass Harp St
		9	Glass Harp Mono
11	Choir	1	Choir Aah CM
		2	Choir Doo CM
		3	Vocal CM Tn/S
		4	Choir Taped
12	Synth Pad	1	PWM
		2	EPFM Pad
		3	WG Pad Bright
		4	WG Pad Mellow
		5	Noise Choir
13	Bass	1	Acoustic Bs On
		2	Acoustic Bs Off
		3	Finger Bs Jz
		4	Finger Bs Pr
		5	Pick Bs Jz
		6	Pick Bs Pr
		7	Slap Bs Jz
		8	FM Bass
		9	Timpani Single
		10	Timpani Roll
		11	Timpani Griss
14	Synth Lead	1	Square
		2	Pulse 66%
		3	Pulse 75%
		4	Pulse 80%
		5	Sawtooth
		6	Kinura
		7	Lucy
		8	Even Bars
		9	OPZ LFO
		10	Osc. Sync U/D

	Category		Name
		11	Osc. Sync D
15	Free Reed	1	Accordion
		2	Acn SubOct
		3	Reed Organ
		4	Melodion B-24
		5	Melodion M-37
		6	Melodion M-37Oct
		7	Melodion PRO-44
		8	Melodion S-32
		9	Harm Single
		10	Harm Chro Norm
		11	Harm Chro Vib
		12	Harm BsChro
		13	Harm Bass Stacc
		14	Harm FM
16	Percussion	1	Ride Cymbal
		2	Crash Cymbal
		3	Crash Cymbal Lp
		4	Wind Chime
		5	Wind Chime Lp
		6	Tone Tang
		7	Jazz BD
		8	Jazz SD
		9	Jazz SD&BD Rnd
		10	Brush SD Swl On
		11	Brush SD Swl Off
		12	Brsh SD Tap/Slap
		13	Brush SD&BD Rnd



## PIPE ORGAN STOPS

#	Pipe Voice
1	C-Open Diapason
2	C-Principal
3	C-Diapason
4	C-Bourdon 1
5	C-Bourdon 2
6	C-Gedeckt
7	C-Rohr Flute
8	C-Flute Hamonic
9	C-Flautino
10	C-Voix Cele II
11	C-Clarinet
12	C-Hautbois
13	C-Oboe
14	C-Vox Humana
15	C-Trompette
16	C-Cornet V
17	C-Mixture III
18	C-Mixture IV
19	C-Reserve
20	C-Reserve
21	C-Reserve
22	T-Tibia Clausa
23	T-Brass Saxophone
24	T-Brass Trumpet
25	T-Clarinet
26	T-Brs E.PostHorn
27	T-Orchestral Oboe
28	T-Style D Trumpet
29	T-Viol d'Orchestle
30	T-Vox Humana
31	T-Viol Celeste
32	T-Reserved
33	T-Reserved
34	P-CotVln 32' & Brdn 16'
35	P-CtlBmb 32' & Prn 16'
36	P-CntBrdn 32' & Flte 16'
37	P-Trompette 16'
38	P-Fagott 16'
39	P-SubBs 16' & Gedeckt 8'
40	P-Diapason 8' & Flute 4'
41	P-PrnChors 8' & Mixt IV
42	P-Tibia 16' & Flute 8'
43	P-Diap 16' & PostHorns
44	P-Cornoepan
45	P-Reserved
46	P-Reserved

**C** Classical  
**T** Theatre  
**P** Pedal

## ProChord VOICING

Close      Open      Duet      Block      Big Band Sax

Big Band      Small Combo      Theatre      Hymn      Quartet 1

Quartet 2      Jazz Brass      Strings      Harmonic Chime      Old Time

4 Part Closed      5 Part Open

The chord voicings for the **Small Combo**, **Hymn**, and **Old Time** patterns are somewhat similar; however, the passing chords are different corresponding to the harmonic style for each pattern.

## MIDI TEMPLATES

## MIDI TEMPLATES

Template		Basic	2 Man Lower	2 Man Upper
Messages	MIDI IN	Sequence	Lower	Upper
	Local Control	On	On	On
	NRPN	On	On	On
	Program Change	On	On	On
	Drawbar Registration	On	On	On
	External Zone	Off	Off	Off
Transmit Channel	Tx. Upper	1	1	1
	Tx. Lower	2	2	2
	Tx. Pedal	3	3	3
	Rx. Upper	1	1 (disregarded, off)	1 (disregarded, off)
	Rx. Lower	2	2 (disregarded, off)	2 (disregarded, off)
	Rx. Pedal	3	3 (disregarded, omni)	3 (disregarded, omni)
Comments		Record and Playback between the SK PRO (stand alone) and external sequencer.	Play with expanded LOWER Keyboard into the MIDI IN Port. (*1) Your performance will be transmitted from the MIDI OUT Port and recorded by an external sequencer.	Play with expanded UPPER Keyboard into the MIDI IN Port. Same as (*1).

Template		Pedal KBD	3 KBD Lower	3 KBD Upper
Messages	MIDI IN	Pedal	Low + Ped	Up + Ped
	Local Control	On	On	On
	NRPN	On	On	On
	Program Change	On	On	On
	Drawbar Registration	On	On	On
	External Zone	Off	Off	Off
Transmit Channel	Tx. Upper	1	1	1
	Tx. Lower	2	2	2
	Tx. Pedal	3	3	3
	Rx. Upper	1 (disregarded, off)	1	1
	Rx. Lower	2 (disregarded, off)	2	2
	Rx. Pedal	3 (disregarded, omni)	3	3
Comments		Play with expanded Pedalboard into the MIDI IN Port. Same as (*1).	Play with both expanded LOWER Keyboard (Ch. 2) and Pedalboard (Ch. 3) into the MIDI IN Port. Same as (*1).	Play with both expanded UPPER Keyboard (Ch. 1) and Pedalboard (Ch. 3) into the MIDI IN Port. Same as (*1).

Template		Organ Upper	Piano	Ensemble
Messages	MIDI IN	Organ Upper	Piano	Ensemble
	Local Control	On	On	On
	NRPN	On	On	On
	Program Change	On	On	On
	Drawbar Registration	On	On	On
	External Zone	Off	Off	Off
Transmit Channel	Tx. Upper	1	1	1
	Tx. Lower	2	2	2
	Tx. Pedal	3	3	3
	Rx. Upper	1 (disregarded, off)	1 (disregarded, off)	1 (disregarded, off)
	Rx. Lower	2 (disregarded, off)	2 (disregarded, off)	2 (disregarded, off)
	Rx. Pedal	3 (disregarded, off)	3 (disregarded, off)	3 (disregarded, off)
Comments		Play the ORGAN Section Upper directly by expanded MIDI keyboard into the MIDI IN Port.	Play the PIANO Section directly by expanded MIDI keyboard into the MIDI IN Port.	Play the ENSEMBLE Section directly by expanded MIDI keyboard into the MIDI IN Port.

Template		Synth	EXZ	EXZ 2 Man Lower
Messages	MIDI IN	Synth	Sequence	Lower
	Local Control	On	On	On
	NRPN	On	On	On
	Program Change	On	On	On
	Drawbar Registration	On	On	On
	External Zone	Off	On	On
Transmit Channel	Tx. Upper	1	Off	Off
	Tx. Lower	2	Off	Off
	Tx. Pedal	3	Off	Off
	Rx. Upper	1 (disregarded, off)	Off	Off
	Rx. Lower	2 (disregarded, off)	Off	Off
	Rx. Pedal	3 (disregarded, off)	Off	Off
Comments		Play the MONO SYNTH Section directly by expanded MIDI keyboard into the MIDI IN Port.	(*2) Control the MIDI equipment by using External Zones and MIDI OUT Port.	Play with expanded LOWER Keyboard into the MIDI IN Port. Same as (*2).

Template		ExZ 2 Man Upper	EXZ Pedal KBD	EXZ 3 KBD Lower
Messages	MIDI IN	Upper	Pedal	Low + Ped
	Local Control	On	On	On
	NRPN	On	On	On
	Program Change	On	On	On
	Drawbar Registration	On	On	On
	External Zone	On	On	On
Transmit Channel	Tx. Upper	Off	Off	Off
	Tx. Lower	Off	Off	Off
	Tx. Pedal	Off	Off	Off
	Rx. Upper	Off	1 (disregarded, off)	1
	Rx. Lower	Off	2 (disregarded, off)	2
	Rx. Pedal	Off	3 (disregarded, omni)	3
Comments		Play with expanded UPPER Keyboard into the MIDI IN Port. Same as (*2).	Play with expanded Pedalboard into the MIDI IN Port. Same as (*2).	Play with both expanded LOWER Keyboard (Ch. 2) and Pedalboard (Ch. 3) into the MIDI IN Port. Same as (*2).

Template		EXZ 3 KBD Upper
Messages	MIDI IN	Up + Ped
	Local Control	On
	NRPN	On
	Program Change	On
	Drawbar Registration	On
	External Zone	On
Transmit Channel	Tx. Upper	Off
	Tx. Lower	Off
	Tx. Pedal	Off
	Rx. Upper	1
	Rx. Lower	2
Rx. Pedal	3	
Comments		Play with both expanded UPPER Keyboard (Ch. 1) and Pedalboard (Ch. 3) into the MIDI IN Port. Same as (*2).

## MIDI IMPLEMENTATION

### CHANNEL VOICE MESSAGES

#### Note Off

Status	2nd Byte	3rd Byte
8nH	kkH	vvH, or
9nH	kkH	00H
n=MIDI Channel Number:	0H - FH (Ch. 1 - 16)	
kk=Note Number:	00H - 7FH (0 - 127)	
vv=Velocity(disregard):	00H - 7FH (0 - 127)	

#### Note On

Status	2nd Byte	3rd Byte
9nH	kkH	vvH
n=MIDI Channel Number:	0H - FH (Ch. 1 - 16)	
kk=Note Number:	00H - 7FH (0 - 127)	
vv=Velocity:	00H - 7FH (0 - 127)	

#### Control Change

##### Bank Select (CC#0, 32)

Status	2nd Byte	3rd Byte
BnH	00H	mmH
BnH	20H	llH
n=MIDI Channel Number:	0H - FH (Ch. 1 - 16)	
mm,ll=Bank Number:	00H 00H = Bundle	
	01H 00H = User	
	02H 00H = Factory	
	64H 00H - 6DH 00H = Bank [1] to [10]	

*Disregards if the received number is empty.*

##### Expression (CC#11)

Status	2nd Byte	3rd Byte
BnH	0BH	vvH
n=MIDI Channel Number:	0H - FH (Ch. 1 - 16)	
vv=Expression:	00H - 7FH (0 - 127)	

##### Spring Shock (CC#48)

Status	2nd Byte	3rd Byte
BnH	30H	vvH
n=MIDI Channel Number:	0H - FH (Ch. 1 - 16)	
vv=Velocity:	00H - 7FH (0 - 127)	

##### TW Brake (CC#49)

Status	2nd Byte	3rd Byte
BnH	31H	vvH
n=MIDI Channel Number:	0H - FH (Ch. 1 - 16)	
vv=Control Value:	00H - 7FH (0 - 127)	
	0 - 63=Off, 64 - 127=On	

##### Damper (CC#64)

Status	2nd Byte	3rd Byte
BnH	40H	vvH
n=MIDI Channel Number:	0H - FH (Ch. 1 - 16)	
vv=Control Value:	00H - 7FH (0 - 127)	
	0 - 63=Off, 64 - 127=On	

##### Portamento Switch (CC#65)

Status	2nd Byte	3rd Byte
BnH	41H	vvH
n=MIDI Channel Number:	0H - FH (Ch. 1 - 16)	
vv=Control Value:	00H - 7FH (0 - 127)	
	0 - 63=Off, 64 - 127=On	

##### Sustain (CC#69-adds Sustain to Upper and Lower ORGAN Parts)

Status	2nd Byte	3rd Byte
BnH	45H	vvH
n=MIDI Channel Number:	0H - FH (Ch. 1 - 16)	
vv=Control Value:	00H - 7FH (0 - 127)	
	0 - 63=Off, 64 - 127=On	

##### ProChord Active (CC#84)

Status	2nd Byte	3rd Byte
BnH	54H	vvH

n=MIDI Channel Number:	0H - FH (Ch. 1 - 16)
vv=Control Value:	00H - 7FH (0 - 127)
	0 - 63=Off, 64 - 127=On

*Activates "Harmony" parts for ORGAN Section when this Parameter is "On."*

##### Leslie Fast (CC#92)

Status	2nd Byte	3rd Byte
BnH	5CH	vvH
n=MIDI Channel Number:	0H - FH (Ch. 1 - 16)	
vv=Control Value:	00H - 7FH (0 - 127)	
	0 - 63=Off, 64 - 127=On	

*This control change is only for receive.*

##### NRPN MSB/LSB (CC#98, 99)

Status	2nd Byte	3rd Byte
BnH	63H	mmH
BnH	62H	llH
n=MIDI Channel Number:	0H - FH (Ch. 1 - 16)	
mm=upper byte of the Parameter number specified by NRPN		
ll=lower byte of the Parameter number specified by NRPN		

##### Data Entry (CC#6, 38)

Status	2nd Byte	3rd Byte
BnH	06H	mmH
BnH	26H	llH
n=MIDI Channel Number:	0H - FH (Ch. 1 - 16)	
mm,ll=the value of the Parameter specified by NRPN		

##### Program Change

Status	2nd Byte
CnH	ppH
n=MIDI Channel Number:	0H - FH (Ch. 1 - 16)
pp=Program Number:	00H - 63H = Patch #0 to 99
	64H - 6DH = Favo. Number [1] to [10]
	7FH = [Manual]

##### Example of operation

###### ex: select Combi F016

Bx 00 02 Bx 20 00 Cx 0F (x=Upper Channel)

###### ex: select Favorite Bank[2], Number[6]

Bx 00 65 Bx 20 00 Cx 69 (x=Upper Channel)

###### ex: select Manual

Cx 7F (x=Upper Channel)

## CHANNEL MODE MESSAGES

##### All Sounds Off (CC#120)

Status	2nd Byte	3rd Byte
BnH	78H	00H
n=MIDI Channel Number:	0H - FH (Ch. 1 - 16)	

*When this message is received, all currently-sounding notes on the corresponding channel will be turned off immediately.*

##### Reset All Controllers (CC#121)

Status	2nd Byte	3rd Byte
BnH	79H	00H
n=MIDI Channel Number:	0H - FH (Ch. 1 - 16)	

*When this message is received, the following controllers will be set to their reset values.*

Expression: 127, TW Brake: 0, Damper: 0  
NRPN: unset; previously set data will not change

##### All Notes Off (CC#123)

Status	2nd Byte	3rd Byte
BnH	7BH	00H
n=MIDI Channel Number:	0H - FH (Ch. 1 - 16)	

*When All Notes Off is received, all notes on the corresponding channel will be turned off. However if Hold 1 or Sostenuto is ON, the sound will be continued until these are turned off.*

## DRAWBAR DATA LIST

Part	Control Number								
	16'	5 1/2'	8'	4'	2 2/3'	2'	1 3/5'	1 1/2'	1'
Upper	0CH(12)	0DH(13)	0EH(14)	0FH(15)	10H(16)	11H(17)	12H(18)	13H(19)	14H(20)
Lower	15H(21)	16H(22)	17H(23)	18H(24)	19H(25)	1AH(26)	1BH(27)	1CH(28)	1DH(29)
Pedal	21H(33)	-	23H(35)	-	-	-	-	-	-

Value	Level								
	0	1	2	3	4	5	6	7	8
	00 - 0FH (0 - 15)	10 - 1FH (16 - 31)	20 - 2FH (32 - 47)	30 - 3FH (48 - 63)	40 - 4FH (64 - 79)	50 - 5FH (80 - 95)	60 - 6FH (96 - 111)	70 - 7EH (112-126)	7FH (127)

ex: Set Lower 8' to level 7 via MIDI. Bx 17 70 (x=Upper Channel)

## SYSTEM EXCLUSIVE MESSAGE

### MEMORY DUMP

1. Each Packet (139 Bytes)

F0	System Exclusive
55	SUZUKI ID
dd	Device ID (refer to page 157)
10	Model ID MSB
24	Model ID LSB
11	Command: Data Packet
[TYPE]	Data Type 07H, 08H = Temp. Dump 0AH = System Dump
[PNH]	Packet Number MSB
[PNL]	Packet Number LSB
[DATA]	64 Bytes Data 128 Bytes nibblized ASCII ex: 7EH = 37H, 45H
[CHD]	Check Digit Lower 7 bits of XOR [DATA]
F7	End Of Exclusive

2. Acknowledge

F0	System Exclusive
55	SUZUKI ID
dd	Device ID
10	Model ID MSB
24	Model ID LSB
14	Command: Acknowledge
[TYPE]	Data Type
[AK]	Result 00H = OK 05H = Check Digit Error 06H = Receive Protected
[PNH]	Packet Number MSB
[PNL]	Packet Number LSB
F7	End Of Exclusive

3. # of Packets

Temp. Dump: 46  
System Dump: 11

### DUMP REQUEST (RX. ONLY)

F0	System Exclusive
55	SUZUKI ID
dd	Device ID
10	Model ID MSB
24	Model ID LSB
12	Command: Dump Request
[TYPE]	Data Type 07H = Temp. Dump 0AH = System Dump
F7	End Of Exclusive

### NRPN SWITCH

F0	Suzuki Exclusive
55	SUZUKI ID
dd	Device ID
10	Model ID MSB
24	Model ID LSB
02	Command: NRPN Sw.
[DATA]	00H = Off, 7FH = On
F7	End Of Exclusive

When this device receives this message, Tx & Rx NRPN is switched in the Control channel.

### DATA SET (RX. ONLY)

F0	System Exclusive
55	SUZUKI ID
dd	Device ID
10	Model ID MSB
24	Model ID LSB
13	Command: Data Set
aa	Address MSB
bb	Address
cc	Address LSB
[DATA]	Data (Flexible bytes)
F7	End Of Exclusive

### IDENTITY REQUEST (RX. ONLY)

F0	System Exclusive
7E	Universal non real-time
dd	Device ID
06	Sub ID #1
01	Sub ID #2
F7	End Of Exclusive

### IDENTITY REPLY (TX. ONLY)

F0	System Exclusive
7E	Universal non real-time
dd	Device ID
06	Sub ID #1
02	Sub ID #2
55	SUZUKI ID
00 10	Device Family code
00 24	Device Family number
00 00	
00 00	
F7	End Of Exclusive

When Identity Request is received, Identity Reply will be transmitted.

# COMBINATION PARAMETERS

Category	Parameter	NRPN		SysEx Address			SysEx Length	Data	
		MSB (63)	LSB (62)	MSB to LSB				Data length 01 uses MSB only, length 02 uses MSB and LSB.	
Name		--	--	--	--	--	--	16 letters	
Portamento	On	--	--	--	--	--	01	00, 01 (Off, On)	
Reverb	On	10	00	00	10	00	01	00, 01 (Off, On)	
	Type (P/E/S)	10	01	00	10	01	01	00 - 07 00: Room 1                    05: Church 01: Room 2                    06: Plate 02: Ballroom                   07: Spring 03: Hall 1 04: Hall 2	
	Depth	10	02	00	10	02	01	00 - 7F (0 - 127)	
	Time (P/E/S)	10	03	00	10	03	01	00 - 7F (0 - 127)	
	Pre-LPF (P/E/S)	10	04	00	10	04	01	00 - 7F (0 - 127)	
	Type (Organ)	10	06	00	10	06	01	Same as P/E/S	
	Time (Organ)	10	07	00	10	07	01	00 - 7F (0 - 127)	
Pre-LPF (Organ)	10	08	00	10	08	01	00 - 7F (0 - 127)		
Organ Upper	Patch	11	00	00	11	00	02	00 00 - 00 63, 00 64 - 01 47, 01 48 - 02 2B (B001 - B100, U001 - U100, F001 - F100)	
	Octave	11	01	00	11	01	02	3F 7E - 40 00 - 40 02 (-2 - ±0 - +2)	
	Transpose	11	02	00	11	02	02	3F 7A - 40 00 - 40 06 (-6 - ±0 - +6)	
	Allocate	11	03	00	11	03	01	00 - 03 (Off, Upper, Lower, Pedal)	
	Key Range Low	11	04	00	11	04	01	00 - 7F: note number	
	Key Range High	11	05	00	11	05	01	00 - 7F: note number	
	Volume	11	06	00	11	06	01	00 - 7F (0 - 127)	
	Expression Minimum	11	07	00	11	07	01	00 - 7F (0 - 127)	
	P. Bend Range	11	08	00	11	08	01	00 - 0E (Patch, 0 - 12)	
	Mod. Mode	11	09	00	11	09	01	00 - 03 (Off, OD, MFx1, MFx2)	
	Damper Enable	11	0A	00	11	0A	01	00, 01 (Off, On)	
	Reverb Send Level	11	0B	00	11	0B	01	00 - 7F (0 - 127)	
	3 Part Organ	11	0C	00	11	0C	01	00, 01 (Off, On)	
Organ Lower	Octave	12	01	00	12	01	02	3F 7E - 40 00 - 40 02 (-2 - ±0 - +2)	
	Transpose	12	02	00	12	02	02	3F 7A - 40 00 - 40 06 (-6 - ±0 - +6)	
	Allocate	12	03	00	12	03	01	00 - 03 (Off, Upper, Lower, Pedal)	
	Key Range Low	12	04	00	12	04	01	00 - 7F: note number	
	Key Range High	12	05	00	12	05	01	00 - 7F: note number	
	Damper Enable	12	0A	00	12	0A	01	00, 01 (Off, On)	
Organ Pedal	Octave	13	01	00	13	01	02	3F 7E - 40 00 - 40 02 (-2 - ±0 - +2)	
	Transpose	13	02	00	13	02	02	3F 7A - 40 00 - 40 06 (-6 - ±0 - +6)	
	Allocate	13	03	00	13	03	01	00 - 03 (Off, Upper, Lower, Pedal)	
	Key Range Low	13	04	00	13	04	01	00 - 7F: note number	
	Key Range High	13	05	00	13	05	01	00 - 7F: note number	
	Damper Enable	13	0A	00	13	0A	01	00, 01 (Off, On)	
Piano, Ensemble, Synth  "s" means; 4: Piano 5: Ensemble 6: Synth	Patch	1s	00	00	1s	00	02	Piano / Ensemble: 00 00 - 03 0F, 03 10 - 06 1F (U001 - U400, F001 - F400) Mono Synth: 00 00 - 00 63, 00 64 - 01 47, 01 48 - 02 2B (B001 - B100, U001 - U400, F001 - F100)	
	Octave	1s	01	00	1s	01	02	3F 7E - 40 00 - 40 02 (-2 - ±0 - +2)	
	Transpose	1s	02	00	1s	02	02	3F 7A - 40 00 - 40 06 (-6 - ±0 - +6)	
	Allocate	1s	03	00	1s	03	01	00 - 03 (Off, Upper, Lower, Pedal)	
	Key Range Low	1s	04	00	1s	04	01	00 - 7F: note number	
	Key Range High	1s	05	00	1s	05	01	00 - 7F: note number	
	Volume	1s	06	00	1s	06	01	00 - 7F (0 - 127)	
	Expression Minimum	1s	07	00	1s	07	01	00 - 7F (0 - 127)	
	P. Bend Range	1s	08	00	1s	08	01	00 - 0E (Patch, 0 - 12)	
	Mod. Mode	1s	09	00	1s	09	01	00 - 03 (Off, Mod, OD, MFx1, MFx2)	
	Damper Enable	1s	0A	00	1s	0A	01	00, 01 (Off, On)	
	Reverb Send Level	1s	0B	00	1s	0B	01	00 - 7F (0 - 127)	
	Velocity Curve	1s	0D	00	1s	0D	01	00 - 04 (Off, 1 - 4)	
	Internal Zones	Octave Upper	17	00	00	17	00	02	3F 7E - 40 00 - 40 02 (-2 - ±0 - +2)
		Octave Lower	17	01	00	17	01	02	3F 7E - 40 00 - 40 02 (-2 - ±0 - +2)
		Octave Pedal	17	02	00	17	02	02	3F 7E - 40 00 - 40 02 (-2 - ±0 - +2)
		Octave Real Lower	17	03	00	17	03	02	3F 7E - 40 00 - 40 02 (-2 - ±0 - +2)
Split On		17	04	00	17	04	01	00, 01 (Off, On)	
SPLIT Point		17	05	00	17	05	01	00 - 7F: note number	
Pedal to Lower On		17	06	00	17	06	01	00, 01 (Off, On)	
Pedal to Lower Upper Limit		17	07	00	17	07	01	00 - 7F: note number	
Pedal to Lower Mode		17	08	00	17	08	01	00 - 02 (Lowest, Chord, Poly)	
Pedal Sustain On		17	09	00	17	09	01	00, 01 (Off, On)	
Pedal Sustain Length		17	0A	00	17	0A	01	00 - 04 (1 - 5)	
Pedal Key Mono/Poly		17	0B	00	17	0B	01	00, 01 (Mono, Poly)	

Category	Parameter	NRPN		SysEx Address			SysEx Length	Data Data length 01 uses MSB only, length 02 uses MSB and LSB.
		MSB (63)	LSB (62)	MSB to LSB				
	On	1n	00	00	1n	00	01	00, 01 (Off, On)
	MIDI Channel	1n	01	00	1n	01	01	00 - 0F (1 - 16)
External Zones "n" means; 8: Ex Zone 1 9: Ex Zone 2 A: Ex Zone 3	Octave	1n	02	00	1n	02	02	3F 7E - 40 00 - 40 02 (-2 - ±0 - +2)
	Transpose	1n	03	00	1n	03	02	3F 7A - 40 00 - 40 06 (-6 - ±0 - +6)
	Bank Select MSB	1n	04	00	1n	04	01	00 - 7F (0 - 127)
	Bank Select LSB	1n	05	00	1n	05	01	00 - 7F (0 - 127)
	Program Change	1n	06	00	1n	06	01	00 - 7F (0 - 127)
	Allocate	1n	07	00	1n	07	01	00 - 03 (Off, Upper, Lower, Pedal)
	Key Range Low	1n	08	00	1n	08	01	00 - 7F: note number
	Key Range High	1n	09	00	1n	09	01	00 - 7F: note number
	Volume	1n	0A	00	1n	0A	01	00 - 7F (0 - 127)
	Expression Enable	1n	0B	00	1n	0B	01	00, 01 (Off, On)
	P. Bend Enable	1n	0C	00	1n	0C	01	00, 01 (Off, On)
	Mod. Enable	1n	0D	00	1n	0D	01	00, 01 (Off, On)
	Damper Enable	1n	0E	00	1n	0E	01	00, 01 (Off, On)
	Pan	1n	0F	00	1n	0F	01	00 - 40 - 7F (Left - Center - Right)
	Velocity Curve	1n	10	00	1n	10	01	00 - 04 (Off, Hard - Easy)
	Expression Minimum	1n	11	00	1n	11	01	00 - 3F (0 - 63)
	Expression Maximum	1n	12	00	1n	12	01	40 - 7F (64 - 127)
Expression CC	1n	13	00	1n	13	01	00, 01, 02 (Off, 7, 11)	

## ORGAN PATCH PARAMETERS

Category	Parameter	NRPN		SysEx Address			SysEx Length	Data
		MSB (63)	LSB (62)	MSB to LSB				
Name	Patch Name	--	--	--	--	--	--	16 letters
Volume	Patch Volume	24	14	00	24	14	01	00 - 7F (0 - 127)
Upper Registration	16'	--	--	00	21	00	01	00 - 08 (0 - 8)
	5 1/3'	--	--	00	21	01	01	00 - 08 (0 - 8)
	8'	--	--	00	21	02	01	00 - 08 (0 - 8)
	4'	--	--	00	21	03	01	00 - 08 (0 - 8)
	2 2/3'	--	--	00	21	04	01	00 - 08 (0 - 8)
	2'	--	--	00	21	05	01	00 - 08 (0 - 8)
	1 3/5'	--	--	00	21	06	01	00 - 08 (0 - 8)
	1 1/3'	--	--	00	21	07	01	00 - 08 (0 - 8)
1'	--	--	00	21	08	01	00 - 08 (0 - 8)	
Lower Registration	16'	--	--	00	22	00	01	00 - 08 (0 - 8)
	5 1/3'	--	--	00	22	01	01	00 - 08 (0 - 8)
	8'	--	--	00	22	02	01	00 - 08 (0 - 8)
	4'	--	--	00	22	03	01	00 - 08 (0 - 8)
	2 2/3'	--	--	00	22	04	01	00 - 08 (0 - 8)
	2'	--	--	00	22	05	01	00 - 08 (0 - 8)
	1 3/5'	--	--	00	22	06	01	00 - 08 (0 - 8)
	1 1/3'	--	--	00	22	07	01	00 - 08 (0 - 8)
1'	--	--	00	22	08	01	00 - 08 (0 - 8)	
Pedal Registration	16'	--	--	00	23	00	01	00 - 08 (0 - 8)
	8'	--	--	00	23	01	01	00 - 08 (0 - 8)
Lower and Upper	ORGAN Type	24	00	00	24	00	01	00 - 07 00: A-100 01: B-3 02: C-3 03: Mellow 04: Vx 05: Farf 06: Ace 07: Pipe
	Envelope	24	01	00	24	01	01	00 - 20 00: Contact 01 - 0F: Release 1 - 15 10 - 1E: Attack and Release 1 - 15
	Contact Offset Time	24	02	00	24	02	01	00 - 40 - 7F (-64 - 0 - +63)
	Contact Damping	24	03	00	24	03	01	00 - 1F (0 - 31)
	Leakage Level	24	04	00	24	04	01	00 - 7F (0 - 127)
	Custom TW A-100	24	05	00	24	05	01	00 - 05 (U1 - F3)
	Custom TW B-3	24	06	00	24	06	01	00 - 05 (U1 - F3)
	Custom TW C-3	24	07	00	24	07	01	00 - 05 (U1 - F3)
	Custom TW Mellow	24	08	00	24	08	01	00 - 05 (U1 - F3)
	Custom Pipe	24	0A	00	24	0A	01	00 - 05 (U1 - F3)
	Tone Control	24	0B	00	24	0B	01	00 - 09 - 12 (-9 - +0 +9)
	Contact Delay Velocity On	24	0C	00	24	0C	01	00, 01 (Off, On)
	Contact Delay Velocity Depth	24	0D	00	24	0D	01	00 - 7F (0 - 127)
	Pitch Bend Depth Plus	24	0E	00	24	0E	01	00 - 0C (0 - 12)
	Pitch Bend Depth Minus	24	0F	00	24	0F	01	00 - 18 (0 - 24)
	Sustain Upper On	24	10	00	24	10	01	00, 01 (Off, On)
	Sustain Upper Length	24	11	00	24	11	01	00 - 04 (1 - 5)
	Sustain Lower On	24	12	00	24	12	01	00, 01 (Off, On)
Sustain Lower Length	24	13	00	24	13	01	00 - 04 (1 - 5)	
Pedal	Type	25	00	00	25	00	01	00, 01 (Normal, Muted)
	Envelope	25	01	00	25	01	01	00 - 20 00: Contact 01 - 0F: Release 1 - 15 10 - 1E: Attack and Release 1 - 15
Percussion	Custom Sub Drawbars	25	02	00	25	02	01	00 - 05 (U1 - P3)
	On	26	00	00	26	00	01	00, 01 (Off, On)
	Harmonic	26	01	00	26	01	01	00, 01 (Second, Third)
	Fast Decay	26	02	00	26	02	01	00, 01 (Slow, Fast)
	Volume Soft	26	03	00	26	03	01	00, 01 (Normal, Soft)
	Level at Soft	26	04	00	26	04	01	00 - 63 (0 - 127)
	Level at Normal	26	05	00	26	05	01	00 - 63 (0 - 127)
	Decay at Fast	26	06	00	26	06	01	00 - 18 (0 - 24)
	Decay at Normal	26	07	00	26	07	01	00 - 18 (0 - 24)
	Touch	26	08	00	26	08	01	00, 01 (Off, On)
	1' Cancel	26	09	00	26	09	01	00, 01 (Off, On)
	Drawbar Level	26	0A	00	26	0A	01	00, 01 (0, Soft)



Category	Parameter	NRPN		SysEx Address			SysEx Length	Data
		MSB (63)	LSB (62)	MSB to LSB				
Animation	Leslie Bypass	27	00	00	27	00	01	00, 01 (Off, On)
	Leslie Stop	27	01	00	27	01	01	00, 01 (Off, On)
	Leslie Fast	27	02	00	27	02	01	00, 01 (Off, On)
	Custom Cabinet	27	03	00	27	03	01	00 - 0F (U1 - P8)
	Vibrato Upper	27	04	00	27	04	01	00, 01 (Off, On)
	Vibrato Lower	27	05	00	27	05	01	00, 01 (Off, On)
	Vibrato Mode	27	06	00	27	06	01	00 - 05 (V1 - C3)
	Vibrato Pedal On	27	07	00	27	07	01	00, 01 (Off, On)
	Vibrato Model	27	08	00	27	08	01	00 - 02 (Big Box, Small Box, Metal Box)
	Vibrato Rate	27	09	00	27	09	01	00 - 99 (5.78 - 7.90 Hz)
	Vibrato Chorus Mix	27	0A	00	27	0A	01	00 - 7F (0 - 127)
	Vibrato Rate	27	0E	00	27	0E	01	00 - 7F (0 - 127)
	Vibrato Tremulant	27	0F	00	27	0F	01	00 - 7F (0 - 127)
Leslie On Reverb	27	10	00	27	10	01	00, 01 (Off, On)	
Transformer	Drive Level	28	00	00	28	00	01	00 - 7F (0 - 127)
	Hysteresis	28	01	00	28	01	01	00 - 7F (0 - 127)
	Depth Upper	28	02	00	28	02	01	00 - 7F (0 - 127)
	Depth Percussion	28	03	00	28	03	01	00 - 7F (0 - 127)
	Depth Lower	28	04	00	28	04	01	00 - 7F (0 - 127)
	Depth Pedal On	28	05	00	28	05	01	00 - 7F (0 - 127)
Overdrive	On	28	06	00	28	06	01	00, 01 (Off, On)
	Type	29	00	00	29	00	01	00, 01 (Off, On)
	Type	29	01	00	29	01	01	00 - 03 (Tube Amp, Stomp Box, Clip, EP Amp)
	Drive Level	29	02	00	29	02	01	00 - 7F (0 - 127)
	Exp. Control On	29	03	00	29	03	01	00, 01 (Off, On)
	Crossover Freq	29	04	00	29	04	01	00 - 7F (400Hz - 14.7kHz)
Effect 1, Effect 2	Blend	29	05	00	29	05	01	00 - 7F (0 - 127)
	On	2x	00	00	2x	00	01	00, 01 (Off, On)
	Type	2x	01	00	2x	01	01	00 - 03 for Effect1, 00 - 04 for Effect 2 00: Tremolo                   00: Auto Pan 01: Wah-Wah                 01: Phaser 02: Ring Mod                02: Flanger 03: Compressor             03: Chorus 04: Delay
	Param 1	2x	02	00	2x	02	01	00 - 7F (0 - 127)
	Param 2	2x	03	00	2x	03	01	00 - 7F (0 - 127)
	Param 3	2x	04	00	2x	04	01	00 - 7F (0 - 127)
	Param 4	2x	05	00	2x	05	01	00 - 7F (0 - 127)
	Param 5	2x	06	00	2x	06	01	00 - 7F (0 - 127)
	Param 6	2x	07	00	2x	07	01	00 - 7F (0 - 127)
	Param 7	2x	08	00	2x	08	01	00 - 7F (0 - 127)
Equalizer	Param 8	2x	09	00	2x	09	01	00 - 7F (0 - 127)
	Bass Gain	2C	00	00	2C	00	01	00 - 09 - 12 (-9 - +0 +9)
	Mid Gain	2C	01	00	2C	01	01	00 - 09 - 12 (-9 - +0 +9)
	Treble Gain	2C	02	00	2C	02	01	00 - 09 - 12 (-9 - +0 +9)
	Bass Freq	2C	03	00	2C	03	01	00 - 18 (20 - 308Hz)
	Mid Freq	2C	04	00	2C	04	01	00 - 0F (250 - 3.1kHz)
	Treble Freq	2C	05	00	2C	05	01	00 - 13 (3.0k - 8.0kHz)

"x" means;  
A: Effect 1  
B: Effect 2

## PIANO/ENSEMBLE PATCH PARAMETERS

Category	Parameter	NRPN		SysEx Address			SysEx Length	Data	
		MSB (63)	LSB (62)	MSB to LSB				Data length 01 uses MSB only, length 02 uses MSB and LSB.	
Name	Patch Name	--	--	--	--	--	--	16 letters	
Volume "s" means; 3: Piano 4: Ensemble	Patch Volume	s1	07	00	s1	07	01	00 - 7F (0 - 127)	
Category	Category	--	--	--	--	--	01	00 - 0F 00: A. Piano           08: Wind 01: E. Piano           09: Strings 02: Harpsi           0A: Choir 03: Clav.           0B: Syn. Pad 04: Chro. Perc.   0C: Bass 05: Guitar.       0D: Syn. Lead 06: Ethnic       0E: Free Reed 07: SEX           0F: Percussion	
Portamento	On	s1	00	00	s1	00	01	00, 01 (Off, On)	
	Mode	s1	01	00	s1	01	01	00, 01 (Every, Legato)	
	Rate	s1	02	00	s1	02	01	00 - 7F (0 - 127)	
	Mono/Poly	s1	03	00	s1	03	01	00 - 02 (Mono, Poly, PolySus)	
	Mono Priority	s1	04	00	s1	04	01	00 - 03 (Auto, Last, High, Low)	
	Pitch Bend Range Up	s1	05	00	s1	05	01	00 - 0C (0 - 12)	
	Pitch Bend Range Down	s1	06	00	s1	06	01	00 - 18 (0 - 24)	
ProChord	On	s2	00	00	s2	00	01	00, 01 (Off, On)	
	Mode	s2	01	00	s2	01	01	00 - 10 00: Closed           09: Quartet 1 01: Open           0A: Quartet 2 02: Duet           0B: Jazz Brass 03: Block           0C: Strings 04: Big Band Saxes 0D: Harmonic Chimes 05: Big Band       0E: Old Time 06: Small Combo   0F: Part 4 Closed 07: Theatre       10: Part 5 Open 08: Hymn	
	Disabled	s2	02	00	s2	02	01	00, 01 (Single, Unison)	
	LFO1, LFO2	Trigger Mode	sx	00	00	sx	00	01	00, 01 (Note, Free)
		Waveform	sx	01	00	sx	01	01	00 - 06 (Triangle, Square, Rectangle, Saw Down, Saw Up, S&H, Fluctuation)
		Rate	sx	03	00	sx	03	01	00 - 7F (0 - 127)
	Delay Time	sx	05	00	sx	05	01	00 - 7F (0 - 127)	
	Attack Rate	sx	06	00	sx	06	01	00 - 7F (0 - 127)	
	Attack Rate Key Track	sx	07	00	sx	07	01	00 - 7F (0 - 127)	
Overdrive	On	s5	00	00	s5	00	01	00, 01 (Off, On)	
	Type	s5	01	00	s5	01	01	00 - 03 (Tube Amp, Stomp Box, Clip, EP Amp)	
	Drive Level	s5	02	00	s5	02	01	00 - 7F (0 - 127)	
	Exp. Control On	s5	03	00	s5	03	01	00, 01 (Off, On)	
	Crossover Freq	s5	04	00	s5	04	01	00 - 7F (400Hz - 14.7kHz)	
	Blend	s5	05	00	s5	05	01	00 - 7F (0 - 127)	
Effect 1, Effect 2 "x" means; 6: Effect 1 7: Effect 2	On	sx	00	00	sx	00	01	00, 01 (Off, On)	
	Type	sx	01	00	sx	01	01	00 - 03 for Effect 1, 00 - 04 for Effect 2 00: Tremolo           00: Auto Pan 01: Wah-Wah       01: Phaser 02: Ring Mod       02: Flanger 03: Compressor   03: Chorus 04: Delay	
	Param 1	sx	02	00	sx	02	01	00 - 7F (0 - 127)	
	Param 2	sx	03	00	sx	03	01	00 - 7F (0 - 127)	
	Param 3	sx	04	00	sx	04	01	00 - 7F (0 - 127)	
	Param 4	sx	05	00	sx	05	01	00 - 7F (0 - 127)	
	Param 5	sx	06	00	sx	06	01	00 - 7F (0 - 127)	
	Param 6	sx	07	00	sx	07	01	00 - 7F (0 - 127)	
	Param 7	sx	08	00	sx	08	01	00 - 7F (0 - 127)	
	Param 8	sx	09	00	sx	09	01	00 - 7F (0 - 127)	
	Equalizer	Bass Gain	s8	00	00	s8	00	01	00 - 09 - 12 (-9 - ±0 +9)
		Mid Gain	s8	01	00	s8	01	01	00 - 09 - 12 (-9 - ±0 +9)
		Treble Gain	s8	02	00	s8	02	01	00 - 09 - 12 (-9 - ±0 +9)
Bass Freq		s8	03	00	s8	03	01	00 - 18 (20 - 308Hz)	
Mid Freq		s8	04	00	s8	04	01	00 - 0F (250Hz - 3.1kHz)	
	Treble Freq	s8	05	00	s8	05	01	00 - 13 (3.0k - 8.0kHz)	

Category	Parameter	NRPN		SysEx Address			SysEx Length	Data
		MSB (63)	LSB (62)	MSB to LSB				Data length 01 uses MSB only, length 02 uses MSB and LSB.
Component 1 - 4 "x" means; 9: Component 1 A: Component 2 B: Component 3 C: Component 4	On	sx	00	00	sx	00	01	00, 01 (Off, On)
	Key Range Low	sx	01	00	sx	01	01	00 - 7F: note number
	Key Range High	sx	02	00	sx	02	01	00 - 7F: note number
	Velocity Range Low	sx	03	00	sx	03	01	01 - 7F (1 - 127)
	Velocity Range High	sx	04	00	sx	04	01	01 - 7F (1 - 127)
	Velocity Depth	sx	05	00	sx	05	01	00 - 7F (0 - 200 %)
	Velocity Offset	sx	06	00	sx	06	01	00 - 40 - 7F (-64 - ±0 - +63)
	Note Delay Source	sx	07	00	sx	07	01	00 - 03 (Component 1 - 4)
	Note Delay Mode	sx	08	00	sx	08	01	00 - 02 (Note On, Off Vel, Off Env)
	Note Off Threshold	sx	09	00	sx	09	01	00 - 7F (0 - 127)
	Note On Delay Time	sx	0A	00	sx	0A	01	00 - 7F (0 - 127)
	Note Off Delay Time	sx	0B	00	sx	0B	01	00 - 7F (0 - 127)
	Pitch EG Key Track Attack	sx	0C	00	sx	0C	01	00 - 7F (0 - 127)
	Pitch EG Key Track Decay	sx	0D	00	sx	0D	01	00 - 7F (0 - 127)
Pitch EG Key Track Slope	sx	0E	00	sx	0E	01	00 - 7F (0 - 127)	
Pitch EG Key Track Release	sx	0F	00	sx	0F	01	00 - 7F (0 - 127)	
Pitch EG Vel Track Attack	sx	10	00	sx	10	01	00 - 7F (0 - 127)	
Pitch EG Vel Track Release	sx	11	00	sx	11	01	00 - 7F (0 - 127)	
Pitch EG Attack Rate	sx	12	00	sx	12	01	00 - 7F (0 - 127)	
Pitch EG Decay Rate	sx	13	00	sx	13	01	00 - 7F (0 - 127)	
Pitch EG Breakpoint Level	sx	14	00	sx	14	01	00 - 7F (0 - 127)	
Pitch EG Slope Rate	sx	15	00	sx	15	01	00 - 7F (0 - 127)	
Pitch EG Sustain Level	sx	16	00	sx	16	01	00 - 7F (0 - 127)	
Pitch EG Release Rate	sx	17	00	sx	17	01	00 - 7F (0 - 127)	
Filter EG Key Track Attack	sx	18	00	sx	18	01	00 - 7F (0 - 127)	
Filter EG Key Track Decay	sx	19	00	sx	19	01	00 - 7F (0 - 127)	
Filter EG Key Track Slope	sx	1A	00	sx	1A	01	00 - 7F (0 - 127)	
Filter EG Key Track Release	sx	1B	00	sx	1B	01	00 - 7F (0 - 127)	
Filter EG Vel Track Attack	sx	1C	00	sx	1C	01	00 - 7F (0 - 127)	
Filter EG Vel Track Release	sx	1D	00	sx	1D	01	00 - 7F (0 - 127)	
Filter EG Attack Rate	sx	1E	00	sx	1E	01	00 - 7F (0 - 127)	
Filter EG Decay Rate	sx	1F	00	sx	1F	01	00 - 7F (0 - 127)	
Filter EG Breakpoint Level	sx	20	00	sx	20	01	00 - 7F (0 - 127)	
Filter EG Slope Rate	sx	21	00	sx	21	01	00 - 7F (0 - 127)	
Filter EG Sustain Level	sx	22	00	sx	22	01	00 - 7F (0 - 127)	
Filter EG Release Rate	sx	23	00	sx	23	01	00 - 7F (0 - 127)	
Amp EG Key Track Attack	sx	24	00	sx	24	01	00 - 7F (0 - 127)	
Amp EG Key Track Decay	sx	25	00	sx	25	01	00 - 7F (0 - 127)	
Amp EG Key Track Slope	sx	26	00	sx	26	01	00 - 7F (0 - 127)	
Amp EG Key Track Release	sx	27	00	sx	27	01	00 - 7F (0 - 127)	
Amp EG Vel Track Attack	sx	28	00	sx	28	01	00 - 7F (0 - 127)	
Amp EG Vel Track Release	sx	29	00	sx	29	01	00 - 7F (0 - 127)	
Amp EG Attack Rate	sx	2A	00	sx	2A	01	00 - 7F (0 - 127)	
Amp EG Decay Rate	sx	2B	00	sx	2B	01	00 - 7F (0 - 127)	
Amp EG Breakpoint Level	sx	2C	00	sx	2C	01	00 - 7F (0 - 127)	
Amp EG Slope Rate	sx	2D	00	sx	2D	01	00 - 7F (0 - 127)	
Amp EG Sustain Level	sx	2E	00	sx	2E	01	00 - 7F (0 - 127)	
Amp EG Release Rate	sx	2F	00	sx	2F	01	00 - 7F (0 - 127)	
Amp EG Coef Attack	sx	30	00	sx	30	01	00 - 7F (0 - 127; Exponential - Linear)	
Amp EG Coef Decay&Slope	sx	31	00	sx	31	01	00 - 7F (0 - 127; Exponential - Linear)	
Amp EG Coef Release	sx	32	00	sx	32	01	00 - 7F (0 - 127; Exponential - Linear)	
Osc Waveform Category	sx	34	00	sx	34	01	00 - 0F (1 - 16)	
Osc Waveform Number	sx	35	00	sx	35	02	00 00 - 01 7F (1 - 256)	
Osc Transpose	sx	36	00	sx	36	02	3F 41 - 40 00 - 40 3F (-63 - ±0 - +63 semitones)	
Osc Fine Tune	sx	37	00	sx	37	02	3F 1C - 40 00 - 40 64 (-100 - ±0 - +100 cents)	
Osc Pitch Key Track	sx	38	00	sx	38	02	3F 1C - 40 00 - 40 64 (-100 - ±0 - +100 %)	
Osc Stretch Tune Depth	sx	39	00	sx	39	01	00 - 7F (0 - 127)	
Osc Pitch Bend On	sx	3A	00	sx	3A	01	00, 01 (Off, On)	
Osc LFO1 Depth	sx	3C	00	sx	3C	01	00 - 7F (0 - 127)	
Osc LFO1 Mod Depth	sx	3D	00	sx	3D	01	00 - 7F (0 - 127)	
Osc LFO2 Depth	sx	3E	00	sx	3E	01	00 - 7F (0 - 127)	
Osc LFO2 Mod Depth	sx	3F	00	sx	3F	01	00 - 7F (0 - 127)	
Osc Pitch EG Depth	sx	40	00	sx	40	02	3F 40 - 40 00 - 40 3F (-64 - ±0 - +63)	
Osc Pitch EG Vel Track	sx	41	00	sx	41	01	00 - 64 (0 - 100 %)	
Filter Mode	sx	44	00	sx	44	01	00, 01 (LP12, HP12)	
Filter Cutoff Freq	sx	45	00	sx	45	01	00 - 7F (0 - 127)	
Filter Resonance	sx	46	00	sx	46	01	00 - 7F (0 - 127)	
Filter Cutoff Key Track	sx	47	00	sx	47	02	3F 1C - 40 00 - 40 64 (-100 - ±0 - +100 %)	
Filter EG Vel Track	sx	48	00	sx	48	01	00 - 7F (0 - 100 %)	
Filter LFO1 Depth	sx	49	00	sx	49	01	00 - 7F (0 - 127)	
Filter LFO1 Mod Depth	sx	4A	00	sx	4A	01	00 - 7F (0 - 127)	
Filter LFO2 Depth	sx	4B	00	sx	4B	01	00 - 7F (0 - 127)	
Filter LFO2 Mod Depth	sx	4C	00	sx	4C	01	00 - 7F (0 - 127)	
Filter Cutoff EG Depth	sx	4E	00	sx	4E	02	3F 1C - 40 00 - 40 64 (-100 - ±0 - +100 %)	

## 188 PIANO/ENSEMBLE PATCH PARAMETERS - continued

Category	Parameter	NRPN		SysEx Address			SysEx Length	Data
		MSB (63)	LSB (62)	MSB to LSB				Data length 01 uses MSB only, length 02 uses MSB and LSB.
	Amp Level Vel Depth	sx	4F	00	sx	4F	02	3F 1C - 40 00 - 40 64 (-100 - ±0 - +100 %)
	Amp Level	sx	51	00	sx	51	01	00 - 7F (0 - 127)
	Amp Pan	sx	52	00	sx	52	01	00 - 40 - 7F (Left - Center - Right)
	Amp Pan Image	sx	53	00	sx	53	01	00 - 04 (Fixed, L-R, R-L, Pyramid, Inverted)
	Amp LFO1 Depth	sx	54	00	sx	54	01	00 - 7F (0 - 127)
	Amp LFO1 Mod Depth	sx	55	00	sx	55	01	00 - 7F (0 - 127)
	Amp LFO2 Depth	sx	56	00	sx	56	01	00 - 7F (0 - 127)
	Amp LFO2 Mod Depth	sx	57	00	sx	57	01	00 - 7F (0 - 127)
	Output Bus	sx	58	00	sx	58	01	00, 01 (Effect, Dry)

# MONO SYNTH PATCH PARAMETERS

Category	Parameter	NRPN		SysEx Address			SysEx Length	Data Data length 01 uses MSB only, length 02 uses MSB and LSB.
		MSB (63)	LSB (62)	MSB to LSB				
Common	Patch Name	--	--	--	--	--	10	16 letters
	Volume	51	00	00	51	00	01	00 - 7F (0 - 127)
	Portamento On	51	01	00	51	01	01	00, 01 (Off, On)
	Portamento Mode	51	02	00	51	02	01	00, 01 (Every, Legato)
	Portamento Rate	51	03	00	51	03	01	00 - 7F (0 - 127)
	LFO Trigger Mode	51	04	00	51	04	01	00, 01 (Note, Free)
	LFO Waveform	51	05	00	51	05	01	00 - 05 (Tri, Sqr, Rect, Saw, S/H, Fluc)
	LFO Rate	51	06	00	51	06	01	00 - 7F (0 - 127)
	LFO Delay Time	51	07	00	51	07	01	00 - 7F (0 - 127)
LFO Attack Rate	51	08	00	51	08	01	00 - 7F (0 - 127)	
LFO Rate Key Track	51	09	00	51	09	01	00 - 7F (0 - 127)	
Oscillator	Osc Note Priority	51	0A	00	51	0A	01	00 - 03 (Auto, Last, High, Low)
	Osc Octave	51	0E	00	51	0E	02	3F 7E - 40 00 - 40 02 (-2 - ±0 - +2)
	Osc Type	51	10	00	51	10	01	00 - 05 00: Duo                    03: Sync 01: Unison                04: FM 02: Pulse                 05: Noise
	Osc Modifier 1	51	11	00	51	11	01	00 - 7F (0 - 127)
	Osc Modifier 2	51	12	00	51	12	01	00 - 7F (0 - 127)
	Osc Modifier 3	51	13	00	51	13	01	00 - 02 (0 - 2)
	Osc Modifier 4	51	14	00	51	14	01	00 - 02 (0 - 2)
	Osc Pitch Key Track	51	15	00	51	15	01	00 - 40 - 7F (-100 - ±0 - +100 cent/note)
	Osc Pitch Bend Range Up	51	16	00	51	16	01	00 - 0C (0 - 12)
	Osc Pitch Bend Range Down	51	17	00	51	17	01	00 - 18 (0 - 24)
	Osc Pitch LFO Depth	51	18	00	51	18	01	00 - 7F (0 - 127)
	Osc Pitch LFO Mod Depth	51	19	00	51	19	01	00 - 7F (0 - 127)
	Osc Pitch EG Depth	51	1A	00	51	1A	01	00 - 40 - 7F (-64 - ±0 - +63)
Filter	Filter Mode	51	1B	00	51	1B	01	00 - 03 (LP12, LP24, HP12, HP24)
	Filter Drive	51	1C	00	51	1C	01	
	Filter Cutoff Freq	51	1D	00	51	1D	01	00 - 7F (0 - 127)
	Filter Resonance	51	1E	00	51	1E	01	00 - 7F (0 - 127)
	Filter Key Track	51	1F	00	51	1F	01	00 - 40 - 7F (-100 - ±0 - +100 cent/note)
	Filter EG Depth	51	20	00	51	20	01	00 - 40 - 7F (-64 - ±0 - +63)
	Filter Lev Vel Track	51	21	00	51	21	01	00 - 7F (0 - 127)
	Filter LFO Depth	51	22	00	51	22	01	00 - 7F (0 - 127)
Filter LFO Mod Depth	51	23	00	51	23	01	00 - 7F (0 - 127)	
Amplifier	Amp Level	51	24	00	51	24	01	00 - 7F (0 - 127)
	Amp Level Vel Depth	51	25	00	51	25	01	00 - 7F (0 - 127)
	Amp LFO Depth	51	27	00	51	27	01	00 - 7F (0 - 127)
	Amp LFO Mod Depth	51	28	00	51	28	01	00 - 7F (0 - 127)
Envelope Generator	EG Trigger Mode	51	29	00	51	29	01	00, 01 (Every, Legato)
	Env Filter Attack	51	2A	00	51	2A	01	00 - 7F (0 - 127)
	Env Filter Decay	51	2B	00	51	2B	01	00 - 7F (0 - 127)
	Env Filter Sustain	51	2C	00	51	2C	01	00 - 7F (0 - 127)
	Env Filter Release	51	2D	00	51	2D	01	00 - 7F (0 - 127)
	Env Amp Attack	51	2E	00	51	2E	01	00 - 7F (0 - 127)
	Env Amp Decay	51	2F	00	51	2F	01	00 - 7F (0 - 127)
	Env Amp Sustain	51	30	00	51	30	01	00 - 7F (0 - 127)
Env Amp Release	51	31	00	51	31	01	00 - 7F (0 - 127)	
Overdrive	On	52	00	00	52	00	01	00, 01 (Off, On)
	Type	52	01	00	52	01	01	00 - 03 (Tube Amp, Stomp Box, Clip, EP Amp)
	Drive Level	52	02	00	52	02	01	00 - 7F (0 - 127)
	Exp. Control On	52	03	00	52	03	01	00, 01 (Off, On)
	Crossover Freq	52	04	00	52	04	01	00 - 7F (400Hz - 14.7kHz)
Blend	52	05	00	52	05	01	00 - 7F (0 - 127)	
Effect 1, Effect 2	On	5x	00	00	5x	00	01	00, 01 (Off, On)
	Type	5x	01	00	5x	01	01	00 - 03 for Effect1, 00 - 04 for Effect 2 00: Tremolo                    00: Auto Pan 01: Wah-Wah                 01: Phaser 02: Ring Mod                02: Flanger 03: Compressor             03: Chorus 04: Delay
	Param 1	5x	02	00	5x	02	01	00 - 7F (0 - 127)
	Param 2	5x	03	00	5x	03	01	00 - 7F (0 - 127)
	Param 3	5x	04	00	5x	04	01	00 - 7F (0 - 127)
	Param 4	5x	05	00	5x	05	01	00 - 7F (0 - 127)
	Param 5	5x	06	00	5x	06	01	00 - 7F (0 - 127)
	Param 6	5x	07	00	5x	07	01	00 - 7F (0 - 127)
	Param 7	5x	08	00	5x	08	01	00 - 7F (0 - 127)
	Param 8	5x	09	00	5x	09	01	00 - 7F (0 - 127)

"x" means;  
3: Effect 1  
4: Effect 2

## 190 MONO SYNTH PATCH PARAMETERS - continued

Category	Parameter	NRPN		SysEx Address			SysEx Length	Data
		MSB (63)	LSB (62)	MSB to LSB				Data length 01 uses MSB only, length 02 uses MSB and LSB.
Equalizer	Bass Gain	55	00	00	55	00	01	00 - 09 - 12 (-9 - ±0 +9)
	Mid Gain	55	01	00	55	01	01	00 - 09 - 12 (-9 - ±0 +9)
	Treble Gain	55	02	00	55	02	01	00 - 09 - 12 (-9 - ±0 +9)
	Bass Freq	55	03	00	55	03	01	00 - 18 (20 - 308Hz)
	Mid Freq	55	04	00	55	04	01	00 - 0F (250 - 3.1kHz)
	Treble Freq	55	05	00	55	05	01	00 - 13 (3.0k - 8.0kHz)

## CUSTOM TONE WHEELS

### A-100

**F1: #35564**

A-102, serial number #35564.

**F2: Shiny**

Leakage tones with even overtones.

**F3: Mixture**

Harmonized leakage tones.

### B-3

**F1: A27563**

B-3, serial number #A27563.

**F2: #364839**

B-3, serial number #364839.

**F3: Mixture**

Harmonized leakage tones.

### C-3

**F1: C155596**

C-3, serial number #C155596.

**F2: Shiny**

Leakage tones with even overtones.

**F3: Mixture**

Harmonized leakage tones.

### Mellow

**F1: Full Flats**

“Flat” frequency response.

**F2: Husky**

Emphasizes upper and lower frequencies.

**F3: Flute Lead**

Boosts middle frequencies.

## CUSTOM SUB DRAWBARS

**F1: B-3 A27563**

**F2: B-3 #364839**

**F3: A-100 #33339**

Each Custom setting replicates the organ shown above.

## CUSTOM LESLIE CABINETS

**122 Gentle**

Replicates 122 cabinet (Large body, peaking horn driver) heard from a distance, rear.

**122 Wild**

Replicates 122 cabinet heard from a closer distance, front.

**31H-Type**

Replicates 31H cabinet heard from a distance, rear.

**147 Gentle**

Replicates 147 cabinet (Large body, wide range) heard from a distance.

**147 Wild**

Replicates 147 cabinet heard from a closer distance, front.

**145 Gentle**

Replicates 145 cabinet (Middle body, slightly narrow range) heard from a distance, rear.

**145 Wild**

Replicates 145 cabinet heard from a closer distance, front.

**PR-40**

Replicates a Hammond tone cabinet.

## CUSTOM PIPES

**Classic**

Classical or Liturgical stops.

**Theatre 1**

Theatre stops based on Wurlitzer Style 210.

**Theatre 2**

Theater stops based on Wurlitzer Style 260 Special.

## CUSTOM TONE WHEEL PARAMETERS

Category	Parameter	SysEx Address			SysEx Length	Data	Description
		MSB	to	LSB			
Temporary Tone Wheels	Name	--	--	--	--	(10 characters)	
	Foldback Low	10	00	01	01	00 - 0C (TW#01 - #12)	
	Foldback High	10	00	02	01	00 - 05 (TW#91 - #96)	
	Wheel Level	10	01	tt	02	00 00 - 01 41 (0 - 193: -inf, -92.0 - +4.0[dB])	tt: Tone Wheel number; 00 - 0B (#01 - #12), 0C - 17 (#F01 - F12), 18 - 66 (#13 - #91), 67 - 6B (#F92 - #F96)
	Wheel HPF	10	02	tt	01	00 - 7F (0 - 127)	
	Leak Trim	10	03	tt	01	00 - 7F (0 - 127)	tt: Fundamental TW #; 00 - 54 (#01 - #73)
	Matrix Level	20	nn	0g	02	00 00 - 01 41 (0 - 193: -inf, -92.0 - +4.0[dB])	nn: Note number g: Footage(0 = 16', 1 = 5 1/3'... 8 = 1')
	Leak Level	30	tt	ll	02	00 00 - 01 41 (0 - 193: -inf, -92.0 - +4.0[dB])	tt: Fundamental TW #; 00 - 54 (#01 - #73) ll: Leaking TW #; 48 - 66 (#61 - #91)

## CUSTOM PEDAL REG. PARAMETERS

Category	Parameter	SysEx Address			SysEx Length	Data	Description
		MSB	to	LSB			
Temporary Pedal Sub Drawbars	Name	--	--	--	--	(10 characters)	
	Normal 16' - 16'	50	00	01	01	00 - 08 (0 - 8)	
	Normal 16' - 5 1/3'	50	00	02	01	00 - 08 (0 - 8)	
	Normal 16' - 8'	50	00	03	01	00 - 08 (0 - 8)	
	Normal 16' - 4'	50	00	04	01	00 - 08 (0 - 8)	
	Normal 16' - 2 2/3'	50	00	05	01	00 - 08 (0 - 8)	
	Normal 16' - 2'	50	00	06	01	00 - 08 (0 - 8)	
	Normal 16' - 1 3/5'	50	00	07	01	00 - 08 (0 - 8)	
	Normal 16' - 1 1/3'	50	00	08	01	00 - 08 (0 - 8)	
	Normal 8' - 16'	50	00	09	01	00 - 08 (0 - 8)	
	Normal 8' - 5 1/3'	50	00	0A	01	00 - 08 (0 - 8)	
	Normal 8' - 8'	50	00	0B	01	00 - 08 (0 - 8)	
	Normal 8' - 4'	50	00	0C	01	00 - 08 (0 - 8)	
	Normal 8' - 2 2/3'	50	00	0D	01	00 - 08 (0 - 8)	
	Normal 8' - 2'	50	00	0E	01	00 - 08 (0 - 8)	
	Normal 8' - 1 3/5'	50	00	0F	01	00 - 08 (0 - 8)	
Normal 8' - 1 1/3'	50	00	10	01	00 - 08 (0 - 8)		

## PIPE PARAMETERS

Category	Parameter	SysEx Address			SysEx Length	Data	Description
		MSB	to	LSB			
Pipes	Name	--	--	--	--	(10 characters)	
	Assign	40	01	pp	02	00 00 - 00 2D (C-Open Diapason - P-Cornocean)	pp: Pipe Stop number 00 - 13 (#01 - #20)
	Tremulant	40	02	pp	01	00, 01 (Off, On)	
	Footage	40	03	pp	01	00 - 09 (32' - 1')	
	Volume	40	04	pp	02	00 00 - 01 41 (0 - 193: -inf, -92.0 - +4.0[dB])	
	Detune	40	05	pp	02	3F 4E - 40 00 - 40 32 (-50 - ±0 - +50[cent])	
	Chiff	40	06	pp	01	00 - 03 (Off, Soft, Normal, Loud)	
	Cut Off Frequency	40	07	pp	02	3F 01 - 40 00 (-127 - 0)	
	Pan - Direction	40	08	pp	01	00 - 40 - 7F (L64 - Center - R63)	
	Pan - Imaging	40	09	pp	01	00 - 04 (Fixed, L-R, R-L, Pyramid, Inverted Pyramid)	



## CUSTOM LESLIE PARAMETERS

Category	Parameter	NRPN		SysEx Address			SysEx Length	Data
		MSB (63)	LSB (62)	MSB	to	LSB		Data length 01 uses MSB only, length 02 uses MSB and LSB.
Cabinet	Name	--	--	--	--	--	--	(10 Characters)
	Speaker	06	17	00	06	17	01	00 - 07 00: 145 Front      04: 122 Front 01: 145 Rear      05: 122 Rear 02: 147 Front      06: Cone Type 03: 147 Rear      07: PR-40
	Slow Speed Horn	06	01	00	06	01	02	00 00, 00 01 - 00 65 (0, 20 - 120 rpm)
	Slow Speed Drum	06	02	00	06	02	02	00 00, 00 01 - 00 65 (0, 20 - 120 rpm)
	Fast Speed Horn	06	03	00	06	03	02	00 00, 00 01 - 02 2D (0, 200 - 500 rpm)
	Fast Speed Drum	06	04	00	06	04	02	00 00, 00 01 - 02 2D (0, 200 - 500 rpm)
	Rise Time Horn	06	09	00	06	09	01	00 - 24 (0.8 - 12.5 sec)
	Rise Time Drum	06	0A	00	06	0A	01	00 - 23 (1.0 - 12.5 sec)
	Fall Time Horn	06	0B	00	06	0B	01	00 - 24 (0.8 - 12.5 sec)
	Fall Time Drum	06	0C	00	06	0C	01	00 - 23 (1.0 - 12.5 sec)
	Brake Time Horn	06	0D	00	06	0D	01	00 - 24 (0.8 - 12.5 sec)
	Brake Time Drum	06	0E	00	06	0E	01	00 - 23 (1.0 - 12.5 sec)
	Delay Time Horn	06	0F	00	06	0F	01	00 - 05 (0.0 - 1.0 sec)
	Delay Time Drum	06	10	00	06	10	01	00 - 05 (0.0 - 1.0 sec)
	Mic. Width Horn	06	11	00	06	11	01	00 - 64 (0 - 100 cm)
	Mic. Width Drum	06	12	00	06	12	01	00 - 64 (0 - 100 cm)
	Mic. Center Horn	06	05	00	06	05	01	0E - 40 - 72 (-50 - ±0 - +50 cm)
	Mic. Center Drum	06	06	00	06	06	01	0E - 40 - 72 (-50 - ±0 - +50 cm)
	Mic. Distance Horn	06	07	00	06	07	02	00 1E - 01 48 (30 - 200 cm)
	Mic. Distance Drum	06	08	00	06	08	02	00 1E - 01 48 (30 - 200 cm)
	Level Horn	06	13	00	06	13	01	00, 01 - 4D (-Inf, -76 - 0 dB)
	Level Drum	06	14	00	06	14	01	00, 01 - 4D (-Inf, -76 - 0 dB)
	Level Sub Bass	06	15	00	06	15	01	00, 01 - 4D (-Inf, -76 - 0 dB)

# SYSTEM PARAMETERS

Category	Parameter	NRPN		SysEx Address			SysEx Length	Data
		MSB (63)	LSB (62)	MSB to LSB				
Tune	Master Tune	01	00	00	01	00	02	032E - 0338 - 0342 (A= 430 - 440 - 450 Hz)
	Transpose	01	01	00	01	01	02	3F 7A - 40 00 - 40 06 (-6 - ±0 - +6 semitones)
	Velocity Offset	01	02	00	01	02	02	3F 60 - 40 00 - 40 20 (-32 ±0 - +32)
	Pitch Bend Depth	01	03	00	01	03	01	00 - 0D (Patch, ±0 - ±12 semitones)
	Organ Sounding Point	01	04	00	01	04	01	00, 01 (Shallow, Deep)
	TW Brake Range	01	05	00	01	05	02	3F 68 - 40 00 - 40 0C (-24 - ±0 - +12 semitones)
	TW Brake Time	01	06	00	01	06	01	00 - 31 (0.1 - 5.0 sec)
	TW Brake Amp	01	07	00	01	07	01	00, 01 (Off, On)
	Transpose Act Organ	01	08	00	01	08	01	00, 01 (Every, Next)
	Transpose Act Pinao	01	09	00	01	09	01	00, 01 (Every, Next)
	Transpose Act Ensemble	01	0A	00	01	0A	01	00, 01 (Every, Next)
	Transpose Act Synth	01	0B	00	01	0B	01	00, 01 (Every, Next)
Expression	Source	02	00	00	02	00	01	00 - 02 (Pedal, MIDI, Both)
	Min. Level	02	01	00	02	01	01	00 - 29 (Off, -40 - ±0dB)
	Min. Limit LF	02	02	00	02	02	01	00 - 29 (Off, -40 - ±0dB)
	Min. Limit HF	02	03	00	02	03	01	00 - 29 (Off, -40 - ±0dB)
	Pedal Type	02	06	00	02	06	01	00, 01 (H or R, Y or K)
	Gain	02	07	00	02	07	01	00 - 3C (70 - 130 %)
	Curve	02	08	00	02	08	01	00 - 02 (Audio, Linear, Capacitor)
Damper	Pedal Type	03	03	00	03	03	01	00 - 03 (Switch, HalfY, HalfR, HalfK)
	Gain	03	04	00	03	04	01	00 - 3C (70 - 130 %)
Foot Switch	Mode Foot Tip	07	00	00	07	00	01	00 - 24
	Mode Foot Ring	07	01	00	07	01	01	00: Off
	Mode Leslie Tip	07	02	00	07	02	01	01: Leslie S/F Alt
	Mode Leslie Ring	07	03	00	07	03	01	02: Leslie S/F Mom
	Leslie Switch Device	07	04	00	07	04	01	03: Leslie S/F Tri
User Button	Mode	08	00	00	08	00	01	00 - 0E
								01: Pedal Sustain
								02: Org U Sustain
								03: Org L Sustain
								04: TW Brake
								05: Spring Shock
								06: MFX2 Delay Time
								07: Organ MFX1
								08: Organ MFX2
								09: Piano MFX1
Display	Short Cut	--	--	--	--	--	--	00 - 03 (0, 1, 2 sec, No)
	Time Out	--	--	--	--	--	--	00 - 03 (4, 8, 16 sec, No)
	Pop Up	--	--	--	--	--	--	00 - 03 (No, 5, 10, 20 sec)
	Auto Power Off	--	--	--	--	--	--	00, 01 (Disable, 30min)
	Knobs	--	--	--	--	--	--	00, 01 (Every, Across)
	USB Mass Storage	--	--	--	--	--	--	00, 01 (Off, On)
Audio	Individual Out	04	00	00	04	00	01	00 - 06
								01: Piano Stereo
								02: Ensemble Stereo
								03: Synth Stereo
	Ext. Leslie Ch.	04	01	00	04	01	01	00 - 02 (1, 3, 1+Line)
Master Equalizer	Use Rotary Out	04	02	00	04	02	01	00, 01 (Off, On)
	Use Pedal Out	04	03	00	04	03	01	00, 01 (Off, On)
	On	05	00	00	05	00	01	00, 01 (Off, On)
	Bass Gain	05	01	00	05	01	01	00 - 09 - 12 (-9 - ±0 +9)
	Mid Gain	05	02	00	05	02	01	00 - 09 - 12 (-9 - ±0 +9)
	Treble Gain	05	03	00	05	03	01	00 - 09 - 12 (-9 - ±0 +9)
	Bass Freq	05	04	00	05	04	01	00 - 18 (20 - 308Hz)
	Treble Freq	05	06	00	05	06	01	00 - 13 (3.0k - 8.0kHz)

Category	Parameter	NRPN		SysEx Address			SysEx Length	Data
		MSB (63)	LSB (62)	MSB to LSB				
MIDI Common	MIDI In Mode	--	--	--	--	--	--	00 - 09 00: Upper            05: Organ Upper 01: Lower            06: Piano 02: Pedal            07: Ensemble 03: Lower+Pedal    08: Synth 04: Upper+Pedal    09: Sequencer
	Local Control	--	--	--	--	--	--	00, 01 (Off, On)
	TRx NRPN	--	--	--	--	--	--	00, 01 (Off, On)
	TRx Program Change	--	--	--	--	--	--	00, 01 (Off, On)
	TRx Drawbar Regi	--	--	--	--	--	--	00, 01 (Off, On)
	Tx Multi Contact	--	--	--	--	--	--	00, 01 (Off, On)
	Rx Multi Contact	--	--	--	--	--	--	00, 01 (Off, On)
	Tx External Zone	--	--	--	--	--	--	00, 01 (Off, On)
	Device ID	--	--	--	--	--	--	00 - 7F (0 - 127)
	Rx Dump	--	--	--	--	--	--	00, 01 (Off, On)
MIDI Channel	Tx Upper	--	--	--	--	--	--	00 - 0F (1 - 16)
	Tx Lower	--	--	--	--	--	--	00 - 0F (1 - 16)
	Tx Pedal	--	--	--	--	--	--	00 - 0F (1 - 16)
	Rx Upper	--	--	--	--	--	--	00 - 0F (1 - 16)
	Rx Lower	--	--	--	--	--	--	00 - 0F (1 - 16)
	Rx Pedal	--	--	--	--	--	--	00 - 0F (1 - 16)
Patch Load	Organ - Link L/P	60	01	00	60	01	01	00, 01 (Off, On)
	Combi - Int Zone	60	02	00	60	02	01	00, 01 (Off, On)
	Combi - Ext Zone	60	03	00	60	03	01	00, 01 (Off, On)
	Organ - Organ Effect	60	04	00	60	04	01	00, 01 (Off, On)
	Organ - Animation	60	05	00	60	05	01	00, 01 (Off, On)
	Combi - Reverb	60	06	00	60	06	01	00, 01 (Off, On)
	Organ - Drawbar	60	07	00	60	07	01	00, 01 (Off, On)
	Organ - Percussion	60	08	00	60	08	01	00, 01 (Off, On)
	Organ - Registration	60	09	00	60	09	01	00, 01 (Off, On)
	Combi - Piano	60	0A	00	60	0A	01	00, 01 (Off, On)
	Combi - Ensemble	60	0B	00	60	0B	01	00, 01 (Off, On)
	Combi - Synth	60	0C	00	60	0C	01	00, 01 (Off, On)
	Combi - Organ	60	0D	00	60	0D	01	00, 01 (Off, On)

## FAVORITES

Category	Parameter	SysEx Address			SysEx Length	Data	Default	Description
		MSB	0b	0n				
Favorites	Assign	73	0b	0n	02	00 00 - 00 63 (B001 - B100), 00 64 - 01 47 (U001 - U100), 01 48 - 02 2B (F001 - F100)	same as Combination#	b: Bank 0 - 9 (1 - 10) n: Number 0 - 9 (1 - 10)

Example Set 5-2 at U005 via System Exclusive.....F0 55 dd 10 24 13 73 04 01 00 68 F7 (dd = Device ID)

## MIDI IMPLEMENTATION CHART

Stage Keyboard  
Model: SK PRO

MIDI Implementation Chart

Date: 12-Nov-2020  
Version: 1.0

Function		Transmitted	Recognized	Remarks
Basic Channel	Default Changed	*1 1 - 16	*1 1 - 16	*1: Upper = 1, Lower = 2, Pedal = 3 when MIDI "Basic" Template is loaded.
Mode	Default Messages Altered	3 X *****	3 X 1	Switched by MIDI In Mode.
Note Number	: True Voice	12 - 120 (61 key)*2 4 - 124 (73 key) *****	0 - 127  0 - 127	*2: with oct. shift
Velocity	Note ON Note OFF	O O	O O	
After Touch	Key's Ch's	X X	X X	
Pitch Bend		O	O	
Control Change	0, 32	O	O	Bank Select MSB, LSB
	1	O	O	Modulation
	6, 38	O	O	Data Entry MSB, LSB
	7	O	X	Volume
	10	O	X	Pan
	11	O	O	Expression
	12 - 20	O	O	Drawbar Reg. Upper
	21 - 29	O	O	Drawbar Reg. Lower
	33, 35	O	O	Drawbar Reg. Pedal
	48	O	O	Spring Shock
	49	O	O	TW Brake
	64	O	O	Damper
	65	O	O	Portamento Sw
	69	O	O	Sustain
	84	O	O	ProChord Active
92	X	O	Leslie Fast	
98, 99	O	O	NRPN LSB, MSB	
Program Change	: True #	O 0 - 127	O 0 - 99, 127	
System Exclusive		O	O	
System Common	: Song Position : Song Select : Tune	X X X	X X X	
System Real Time	: Clock : Commands	X X	X X	
Aux Messages	: All Sounds Off : Reset All Controllers : Local On/Off : All Notes Off : Active Sense : Reset	X O X O O X	O O X O O X	(120) (121)

Mode 1: OMNI ON, POLY    Mode 2: OMNI ON, MONO  
Mode 3: OMNI OFF, POLY    Mode 4: OMNI OFF, MONO

O: Yes  
X: No

	External Zone (Tx. only)	Upper Keyboard	Lower Keyboard	Pedal Keyboard	Sections (Rx. only)
Note	O	O	O	O	O
Pitch Bend	O	O	X	X	O
Modulation	O	O	X	X	O
Volume, Pan (7, 10)	O	X	X	X	X
Expression (11)	O	O *1	X	X	X
Damper (64)	O	O	O	O	O
Portamento (65)	X	O	X	X	X
Sustain (69)	X	O	X	X	X
Drawbar Reg.	X	12 - 20 (Upper) 21 - 29 (Lower) 33, 35 (Pedal)	X	X	X
Spring Shock (48)	X	O	X	X	X
TW Brake (49)	X	O	X	X	X
ProChord Active (84)	X	O	X	X	X
Leslie Fast (92)	X	O *2	X	X	X
RPN (100, 101)	X	X	X	X	X
NRPN (98, 99)	X	O	X	X	X
All Notes Off (123)	O	O	X	X	X
All Sounds Off (120)	X	O *2	X	X	X
Reset All Ctrl. (121)	O	O	X	X	X
After Touch	X	X	X	X	X
Bank Select (0, 32)	Change the voice for each zone.	Combination#	X	X	X
Program Change			X	X	X

\*1: For all Sections/Parts (audio controlled)

\*2: For Rx. only.

O: Yes

X: No

**Sound Engine****ORGAN Section**

MTWI (Modelled Tone Wheel I), Polyphony: 61 (Tone Wheel Organ)

**PIANO/ENSEMBLE Section**

Sampling Sound Engine, Polyphony: 128

**MONO SYNTH Section**

Analog Modeling Synthesizer, Monophonic

**Keyboard**

61/73 note, with velocity, semi-weighted, square-front ("waterfall" type)

**ORGAN Section****Parts**

3 (Upper, Lower, Pedal)

**Drawbars**

1 set, 9 pitches

**Voicing**

Upper & Lower: 8(A-100, B-3, C-3, Mellow, Vx, Farf, Ace, Pipe)

Pedal: 3 (Normal, Muted, Pipe)

**Percussion**

Buttons: On, Volume Soft, Fast Decay, Third Harmonic

**PIANO/ENSEMBLE Section**

Component: 4, LFO: 2

**MONO SYNTH Section****Oscillator**

6 types (Duo, Unison, Pulse, Sync, FM, Noise)

**Filter**

4 types (LP12, LP24, HP12, HP24), Resonance, Drive

**Modulator**

LFO: 1, EG: 2 (Pitch & Filter, Amplitude)

**Effects****ORGAN Section**

Vibrato & Chorus, Multi Effect 1, Overdrive, Multi Effect 2, Matching Transformer, Leslie, Equalizer & Tone Control

**PIANO / ENSEMBLE Section**

For each section: Multi Effect 1, Overdrive, Multi Effect 2, Equalizer

**MONO SYNTH Section**

Multi Effect 1, Overdrive, Multi Effect 2, Equalizer

**Master**

Equalizer, Reverb

**Key Map****Internal Zone**

Transpose, Octave, Split, Pedal To Lower, Allocate, Pedal Sustain

**External Zones**

3 Zones (assignable to each keyboard)

**Controllers**

Pitch Bend wheel, Modulation wheel, Portamento, Leslie (Bypass, Stop, Fast)

**Memory****Favorites**

10 banks x 10 numbers (Combinations), 10 numbers (Pages)

**Combination**

Factory: 100, User: 100, Bundle: 100, Manual

**Organ Patch**

Factory: 100, User: 100, Bundle: 100

**Piano / Ensemble Patch**

Factory: 300, User: 400, Bundle: 100

**Mono Synth Patch**

Factory: 100, User: 100, Bundle: 100

**Custom Tone Wheel**

Factory: 4 x 3, User: 4 x 3

**Custom Pedal Registration**

Factory: 3, User: 3

**Custom Pipe**

Factory: 3, User: 3

**Custom Cabinet**

Factory: 8, User: 8

**Storage**

Internal Memory, USB Flash Drive

**Display**

320 x 240 pixel

**Connections****MIDI**

IN, OUT

**USB**

To Host

**Audio**

Line Out L, R, Headphones, Individual 1, 2, Rotary Out, Organ Pedal Out, Aux In (with Volume control)

**Leslie**

11 - pin, 1 and 3 channels available

**Others**

Foot Switch 1/Leslie Switch, Foot Switch 2, Damper Pedal, Expression Pedal

**Dimensions****SK PRO**

1004(W), 322(D), 109(H) mm

39.5"(W), 12.7"(D), 4.3"(H)

**SK PRO-73**

1170(W), 322(D), 109(H) mm

46.1"(W), 12.7"(D), 4.3"(H)

**Weight****SK PRO**

9.4 kg

20.7 lbs

**SK PRO-73**

11 kg

24.3 lbs

**Accessory**

AC Power Cord

## Index

3 PART ORGAN 36

**A**

Ace 43  
 Allocate 25, 54  
 AMPLITUDE 96, 105  
 AMPLITUDE EG 97, 105  
 App Menu 65  
 Audio 131  
 Auto Power Off 24  
 Aux In 19

**B**

Back Up 24  
 Bank 27  
 BASIC 93  
 Bundle 25, 60

**C**

Combination 25, 26  
 COMBINATION 74  
 Component 90, 93  
 Contact 84  
 Control 132  
 CONTROL 76  
 Cursor 68  
 Custom Leslie 124  
 Custom Pedal Reg. 123  
 Custom Pipe 126  
 Custom Tone Wheels 120

**D**

Damper Pedal 28  
 DAW 154  
 Default 142, 143  
 DELAY 95  
 DELETE 142, 168  
 Drawbar Registration 38  
 Drawbars. Harmonic Drawbars も参照  
 DRAWBARS 82  
 Drawbar Select 36

**E**

Ensemble 46, 90  
 Envelope Generator 94, 103  
 EQUALIZER 116  
 Expression Pedal 28  
 External Zone Channels 152  
 External Zones 78

**F**

Factory 25  
 Factory Settings 24  
 Farf 43  
 Favorites 25, 27, 71, 139  
 Filter 96, 104  
 FILTER EG 96  
 Foot Switch 28  
 Function Mode 68

**G**

GENERAL 82, 91, 101  
 Global 140

**H**

Harmonic Drawbars 38

**I**

Icon 68  
 Individual Out 19  
 Information 144  
 Initialize 24, 74, 81, 98, 100, 163  
 Internal Memory 164  
 Internal Zones 77

**K**

Keyboard Channels 152

**L**

LESLIE 88  
 Leslie Speaker 17  
 LFO 92, 102  
 List Window 68  
 LOAD 167  
 Lock 72  
 LOUDNESS 82, 91

**M**

Manual 29  
 Master Equalizer 56  
 Master Tune 59  
 Matching Transformer 87  
 Menu Mode 66  
 MIDI 150, 158  
 MIDI sound module 155  
 Modulation 28  
 Mono Synth 48, 100  
 Multi Effects 106, 112  
 Music Player 19

**N**

Number 27

**O**

Octave 55  
 Organ 30, 80  
 Organ Pedal Out 18  
 ORGAN Type 36  
 OSCILLATOR 94, 103  
 Oscillator Type 53  
 Overdrive 111

**P**

Page 68  
 Parameter 68  
 Part 25, 54  
 Patch 25  
 Patch Load 138  
 Pedal Sustain 55  
 Pedal To Lower 55

Percussion 85  
 Piano 46, 90  
 Pipe 44  
 Pitch Bend 28  
 PITCH BEND 82, 91  
 PITCH EG 94  
 PITCH & FILTER EG 103  
 Play Mode 63  
 Portamento 28  
 PORTAMENTO 91  
 ProChord 91

**R**

RECORD 60, 118, 128, 141  
 Reverb 56, 77  
 Rotary Out 18

**S**

SAVE 166  
 Section 25, 54  
 Section Equalizer 116  
 Sequencer 154  
 SETTING 75  
 Setup File 165  
 SOUND 130  
 Split 54  
 Stretch Tuning 94  
 SUSTAIN 84

**T**

Tone Wheel Organ 38  
 Transpose 58

**U**

Update 145  
 USB 150  
 USB Flash Drive 162  
 USB Mass Storage 164  
 User 25, 28

**V**

Value 68  
 Velocity 93  
 Vibrato & Chorus 86  
 Vx 42

Hammond maintains a policy of continuously improving and upgrading its instruments and therefore reserves the right to change specifications without notice. Although every attempt has been made to insure the accuracy of the descriptive contents of this Manual, total accuracy cannot be guaranteed.

Should the owner require further assistance, inquiries should first be made to your Authorized Hammond Dealer. If you still need further assistance, contact Hammond at the following addresses:

In the United States Contact:

**HAMMOND SUZUKI USA, Inc.**

219 W. Wrightwood Ave.

Elmhurst, Illinois 60126

UNITED STATES

Tel: (630) 543-0277

Fax: (630) 543-0279

Web site: [www.hammondorganco.com](http://www.hammondorganco.com)

E-mail: [info@hammondorganco.com](mailto:info@hammondorganco.com)

**Product Registration**

<http://hammondorganco.com/support/online-product-registration/>



In European countries contact:

**HAMMOND SUZUKI EUROPE B. V.**

IR. D. S. Tuynmanweg 4a 4131 PN Vianen

THE NETHERLANDS

Tel: (+31) 347-370 594

Web site: [www.hammond.eu](http://www.hammond.eu)

E-mail: [info@hammond.eu](mailto:info@hammond.eu)

**Product Registration**

<http://www.hammond.eu/support/online-product-registration/>



For other countries:

**SUZUKI CORPORATION**

2-25-7, Ryoke, Naka-ku, Hamamatsu,

Shizuoka Pref. 430-0852

JAPAN

Tel: (+81) 53-460-3781

Fax: (+81) 53-460-3783

E-mail: [suzukicorp@suzuki-music.co.jp](mailto:suzukicorp@suzuki-music.co.jp)

Technical materials are available and can be obtained by mailing a request to the appropriate address listed above marked ATTENTION: SERVICE DEPARTMENT.

Manufacturer:

**SUZUKI MUSICAL INSTRUMENT MFG. Co., Ltd.**

2-25-7, Ryoke, Naka-ku, Hamamatsu, Shizuoka Pref. 430-0852

JAPAN



