

Sk PRO HAMMOND STAGE KEYBOARD

Model: SK PRO/SK PRO-73

Thank you and congratulations on your choice of the Hammond SK PRO/SK PRO-73 Stage Keyboard.

The Hammond SK PRO/SK PRO-73 is an all-new instrument which features the authentic sound of a Vintage Hammond “Tone-Wheel” Organ, plus high-quality voices from the PIANO and ENSEMBLE Sections. The new MONO SYNTH Section completes the instrument to make it the perfect choice for all musical occasions. The SK PRO has 61 keys and the SK PRO-73 has 73 keys.

Please take the time to read this Startup Guide thoroughly in order to take full advantage of the many features of your SK PRO/SK PRO-73. Keep this Startup Guide for future reference.

This Startup Guide describes the basic features of the SK PRO. For a more detailed explanation of the various features, you can download the complete Owner’s Manual at:

<https://www.suzuki-music.co.jp/support/hammond/>

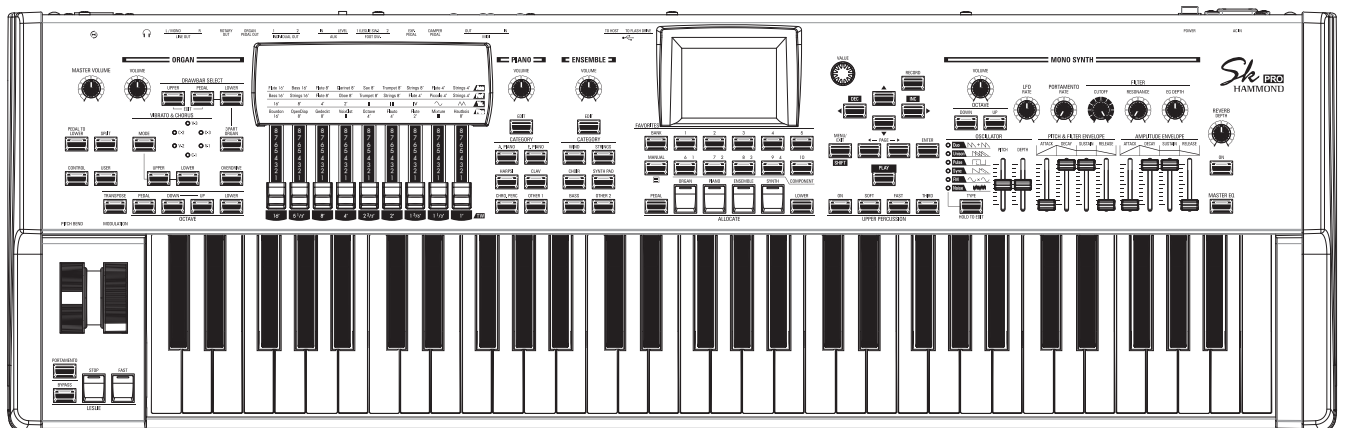

Startup Guide

Read these instructions.

Keep these instructions.

Heed all warnings.

Follow all instructions.

Do not use this apparatus near water.

Clean only with dry cloth.

Do not block any ventilation openings.
Install in accordance with the manufacturer's instructions.

Do not install near any heat sources such as radiators, heat registers, stoves or other apparatus (including amplifiers) that produce heat.

Do not defeat the safety purpose of the polarized or grounding-type plug. A polarized plug has two blades with one wider than the other. A grounding type plug has two blades and a third grounding prong. The wider blade or third prong is provided for your safety. If the provided plug does not fit into your outlet, consult an electrician for replacement of the obsolete outlet.

Protect the power cord from being walked on or pinched, particularly at plugs, convenience receptacles, and the point where they exit from the apparatus.

Only use attachments/accessories specified by the manufacturer.

Use only with the cart, stand, tripod, bracket, or table specified by the manufacturer, or sold with the apparatus. When cart is used: use caution when moving the cart/apparatus combination to avoid injury from tip-over.

PORTABLE CART WARNING



S3125A

Unplug this apparatus during lightning storms, or when unused for long periods of time.

Refer all servicing to qualified service personnel. Servicing is required when the apparatus has been damaged in any way, such as power-supply cord or plug is damaged, liquid has been spilled or objects have fallen into the apparatus, the apparatus has been exposed to rain or moisture, does not operate normally, or has been dropped.

Apparatus shall not be exposed to dripping or splashing and no objects filled with liquids, such as vases, shall be placed on the apparatus.



WARNING: To reduce the risk of fire or electric shock, do not expose this apparatus to rain or moisture.

ATTENTION: Pour réduire les risques de choc électrique ou d'incendie, ne pas exposer cet appareil à la pluie ou à l'humidité.

-THIS APPARATUS MUST BE EARTHED.

-The socket-outlet shall be installed near the apparatus and shall be easily accessible.



| | |
|---|---|
|  | The lightning flash with arrowhead symbol within an equilateral triangle, indicates that dangerous voltage constituting a risk of electric shock is present within this unit. |
|  | The exclamation point within equilateral triangle, indicates that there are important operating and maintenance instructions in the literature accompanying this unit. |

4 IMPORTANT SAFETY INSTRUCTIONS - CONTINUED

FOR THE USA



NOTE: This equipment has been tested and found to comply with the limits for a Class B digital unit, pursuant to part 15 of the FCC rules. These limits are designed to provide reasonable protection against harmful interference in a residential installation. This equipment generates, uses and can radiate radio frequency energy and, if not installed and used in accordance with the instructions, may cause harmful interference to radio communications. However, there is no guarantee that interference will not occur in a particular installation. If this equipment does cause harmful interference to radio or television reception, which can be determined by turning the equipment off and on, the user is encouraged to try to correct the interference by one or more of the following measures:

- ◆ Reorient or relocate the receiving antenna.
- ◆ Increase the separation between the equipment and receiver.
- ◆ Connect the equipment into an outlet on a circuit different from that to which the receiver is connected.
- ◆ Consult the dealer or an experienced radio/TV technician for help.

FOR CANADA

This class B digital apparatus complies with Canadian ICES-003.

Cet appareil numérique de la classe B est conforme à la norme NMB-003 du Canada.

FOR EU COUNTRIES



In case in the future your instrument gets too old to play/use or malfunctions beyond repair, please observe the instructions of this mark, or, if any question, be sure to contact your dealer or your nearest town or municipal office for its proper disposal.

FOR UNITED KINGDOM

FOR YOUR SAFETY, PLEASE READ THE FOLLOWING TEXT CAREFULLY

This appliance is supplied with a molded 3-pin mains plug for your safety and convenience.

The plug contains a 13 amp fuse.

Should the fuse need to be replaced, please ensure that the replacement fuse has a rating of 13 amps and that it is approved by ASTA or BSI to BS11362.

Check for the ASTA mark  or the BSI mark  on the body of the fuse.

If the plug contains a removable fuse cover, you must ensure that it is refitted when the fuse is replaced.

If the fuse cover is lost, the plug must not be used until a replacement cover is obtained.

A replacement fuse cover can be obtained from your local Hammond Dealer.

IF THE FITTED MOULDED PLUG IS UNSUITABLE FOR THE SOCKET OUTLET IN YOUR HOME, THEN THE FUSE SHOULD BE REMOVED AND THE PLUG CUT OFF AND DISPOSED OF SAFELY. THERE IS A DANGER OF SEVERE ELECTRICAL SHOCK IF THE CUT-OFF PLUG IS INSERTED INTO ANY 13 AMP SOCKET.

To replace the fuse, open the fuse compartment with a screwdriver and replace the fuse and fuse cover.

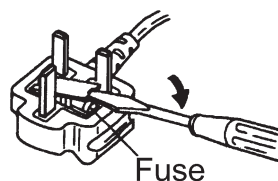

POWER SUPPLY

1. Do not use this unit on the same power circuit with any device that will generate line noise (such as an electric motor or variable lighting system).
2. Before connecting this unit to other devices, turn off the power to all units. This will help prevent malfunctions and/or damage to speakers or other devices.
3. This unit features an Auto Power Off function that automatically turns the power off if the unit is not operated for a specified period of time. The setting will revert to its default value if not backed up before the power is turned off.

PLACEMENT

1. Using the unit near power amplifiers (or other equipment containing large power transformers) may induce hum. To alleviate the problem, change the orientation of this unit; or move it farther away from the source of interference.
2. This device may interfere with radio and television reception. Do not use this device in the vicinity of such receivers.
3. Noise may be produced if wireless communications devices, such as cell phones, are operated in the vicinity of this unit. Such noise could occur when receiving or initiating a call, or while conversing. Should you experience such problems, you should relocate such wireless devices so they are at a greater distance from this unit, or switch them off.
4. Do not expose the unit to direct sunlight, place it near devices that radiate heat, leave it inside an enclosed vehicle, or otherwise subject it to temperature extremes. Also, do not allow lighting devices that normally are used while their light source is very close to the unit (such as a piano light), or powerful spotlights to shine upon the same area of the unit for extended periods of time. Excessive heat can deform or discolor the unit.
5. When moved from one location to another where the temperature and/or humidity is very different, water droplets (condensation) may form inside the unit. Damage or malfunction may result if you attempt to use the unit in this condition. Therefore, before using the unit, you must allow it to stand for several hours, until the condensation has completely evaporated.
6. Do not allow rubber, vinyl, or similar materials to remain on the unit for long periods of time. Such objects can discolor or otherwise harmfully affect the finish.
7. Do not paste stickers, decals, or the like to this instrument. Peeling such matter off the instrument may damage the exterior finish.

MAINTENANCE

8. To clean the unit, use a dry, soft cloth; or one that is slightly dampened.
9. To remove stubborn dirt off plastic parts, use a cloth impregnated with a mild, non-abrasive detergent. Afterwards, be sure to wipe the unit thoroughly with a soft, dry cloth. Try to wipe the entire surface using an equal amount of strength, moving the cloth along with the

grain of the wood. Rubbing too hard in the same area can damage the finish.

10. Never use benzene, thinners, alcohol or solvents of any kind, to avoid the possibility of discoloration and/or deformation.

ADDITIONAL PRECAUTIONS

1. Please be aware that the contents of memory can be irretrievably lost as a result of a malfunction, or the improper operation of the unit. To protect yourself against the risk of losing important data, we recommend that you periodically save a backup copy of important data you have stored in the unit's memory in USB Flash drive.
2. Unfortunately, it may be impossible to restore the contents of data that was stored in another MIDI device (e.g., a sequencer) once it has been lost. Hammond assumes no liability concerning such loss of data.
3. Use a reasonable amount of care when using the unit's buttons, sliders, or other controls; and when using its jacks and connectors. Rough handling can lead to malfunctions.
4. When connecting / disconnecting all cables, grasp the connector itself - never pull on the cable. This will avoid causing short circuits, or damage to the cable's internal elements.
5. To avoid disturbing your neighbors, try to keep the unit's volume at reasonable levels. You may prefer to use headphones, so you do not need to be concerned about those around you (especially when it is late at night).
6. When you need to transport the unit, package it in the box (including padding) that it came in, if possible. Otherwise, you will need to use equivalent packaging materials.

Table Of Contents

| | | | |
|---|-----------|---|----|
| IMPORTANT SAFETY INSTRUCTIONS..... | 3 | USING CONTROLLERS | 23 |
| IMPORTANT - PLEASE READ..... | 5 | INTERNAL CONTROLLERS..... | 23 |
| INTRODUCTION | 6 | EXPRESSION PEDAL..... | 23 |
| NAMES AND FUNCTIONS | 8 | FOOT SWITCH | 23 |
| TOP PANEL | 8 | DAMPER PEDAL..... | 23 |
| LEFT SIDE OF THE KEYBOARD | 10 | MANUAL | 24 |
| REAR PANEL..... | 10 | What is "MANUAL"?..... | 24 |
| KEYBOARD | 12 | INITIALIZE "MANUAL"..... | 24 |
| ACCESSORY | 12 | USING ORGAN PATCHES..... | 25 |
| ACCESSORIES (SOLD SEPARATELY)..... | 12 | ALLOCATING THE SECTION TO THE KEYBOARD..... | 25 |
| MAKING THE CONNECTIONS | 13 | RECALLING A PATCH..... | 25 |
| BASIC CONNECTIONS | 13 | ADJUSTING THE VOLUME | 26 |
| CONNECTING A LESLIE SPEAKER | 14 | CHANGING THE OCTAVE..... | 26 |
| BASIC CONNECTION..... | 14 | CREATING AN ORGAN PATCH..... | 27 |
| 3-CHANNEL TYPE (2101/2101mk2/2103mk2)..... | 14 | SELECT [MANUAL]..... | 27 |
| SINGLE-CHANNEL TYPE (122XB, 981, 3300/W)..... | 14 | INITIALIZE "MANUAL"..... | 27 |
| OTHER AUDIO CONNECTIONS..... | 15 | ALLOCATE THE SECTION TO THE KEYBOARD..... | 27 |
| OUTPUT DRY ORGAN SOUNDS | 15 | SELECT 3 PART ORGAN..... | 27 |
| ROTARY OUT jack..... | 15 | SELECT THE ORGAN TYPE..... | 27 |
| ORGAN PEDAL OUT jack..... | 15 | SELECT THE PART TO ADJUST | 28 |
| USING AN EXTERNAL MIXER..... | 16 | ADD DRAWBARS..... | 28 |
| INDIVIDUAL OUT jacks..... | 16 | ADJUST THE VOLUME..... | 28 |
| USING A MUSIC PLAYER | 16 | CHANGING THE OCTAVE..... | 28 |
| AUX IN jack | 16 | ADDING PERCUSSION..... | 29 |
| EXPANDING THE SK PRO | 17 | ADDING EFFECTS TO THE ORGAN Section..... | 29 |
| DUAL MANUAL OPERATION | 17 | VIBRATO & CHORUS..... | 29 |
| TWO MANUALS + PEDALBOARD | 18 | LESLIE..... | 30 |
| TURN ON AND PLAY..... | 19 | OTHER EFFECTS..... | 30 |
| POWERING ON..... | 19 | ORGAN SECTION IN DETAIL | 31 |
| BACKING UP THE INITIAL SETTINGS..... | 19 | KEYBOARDS AND PARTS..... | 31 |
| AUTO POWER OFF..... | 19 | ORGAN TYPES | 32 |
| RESTORING THE FACTORY SETTINGS | 19 | TONE WHEEL (A-100, B-3, C-3) | 32 |
| STRUCTURE OF THE SK PRO..... | 20 | MELLOW | 32 |
| SECTIONS | 20 | TRANSISTOR (Vx, Farf, Ace)..... | 32 |
| KEYBOARDS AND PARTS..... | 20 | PIPE..... | 32 |
| PARTS..... | 20 | HARMONIC DRAWBARS™ | 33 |
| MEMORY | 20 | DRAWBARS FOR THE UPPER AND LOWER PARTS..... | 34 |
| PATCHES..... | 20 | PEDAL DRAWBARS..... | 34 |
| FACTORY, USER and BUNDLE | 20 | DRAWBAR REGISTRATION PATTERNS..... | 35 |
| COMBINATIONS..... | 20 | MODERN DRAWBAR REGISTRATIONS | 36 |
| FAVORITES..... | 20 | F1: Classic | 39 |
| USING COMBINATIONS..... | 21 | F2: Theatre 1 | 39 |
| WHAT IS A "COMBINATION"?..... | 21 | F3: Theatre 2..... | 39 |
| SELECT A COMBINATION | 21 | ORGAN SECTION OPERATION | 40 |
| FAVORITES-FREQUENTLY USED COMBINATIONS | 22 | MATCHING THE REGISTRATION TO DRAWBARS..... | 40 |
| WHAT IS A "FAVORITE"?..... | 22 | SHOWING CURRENT SETTINGS | 40 |
| BANK AND NUMBER..... | 22 | USING PIANO AND ENSEMBLE PATCHES..... | 41 |
| LINKING A COMBINATION | 22 | ALLOCATING THE SECTION TO THE KEYBOARD..... | 41 |
| TO A FAVORITE..... | 22 | RECALLING A PATCH..... | 41 |
| RECALLING A COMBINATION USING A [FAVORITE] BUTTON | 22 | ADJUSTING THE VOLUME | 42 |
| | | ADJUST THE VELOCITY SENSITIVITY | 42 |
| | | CHANGING THE OCTAVE..... | 42 |
| | | USING MONO SYNTH PATCHES | 43 |
| | | ALLOCATING THE SECTION TO THE KEYBOARD..... | 43 |

| | | | |
|---|-----------|--|----|
| RECALLING A PATCH..... | 43 | HOW TO READ THE DISPLAY | 62 |
| ADJUSTING THE VOLUME | 44 | OPERATION IN THIS MODE..... | 62 |
| CHANGING THE OCTAVE..... | 44 | APP MENU | 62 |
| CREATING A MONO SYNTH PATCH..... | 45 | EXAMPLE OF OPERATION..... | 63 |
| SELECT [MANUAL]..... | 45 | “SHORTCUTS” | 65 |
| ALLOCATE THE SECTION TO THE KEYBOARD..... | 45 | IF YOU FREQUENTLY USE A CERTAIN PAGE.. | 65 |
| LOCATE THE MONO SYNTH CONTROLS | 45 | REGISTER | 65 |
| ADJUST THE VOLUME..... | 45 | DISPLAY THE SAVED PAGE..... | 65 |
| CHANGING THE OCTAVE..... | 45 | LOCKING THE DISPLAY..... | 66 |
| INITIALIZE “MANUAL”..... | 45 | SERVICE | 67 |
| SELECT AN OSCILLATOR..... | 46 | | |
| SLIDE THE PITCH (PORTAMENTO) | 46 | | |
| ADJUST THE BRIGHTNESS (FILTER)..... | 46 | | |
| CHANGING THE SOUND OVER TIME (ENVELOPE) | 46 | | |
| ADDING PERIODIC CHANGING (LFO)..... | 46 | | |
| SELECT THE WAVEFORM (OSCILLATOR TYPE)..... | 46 | | |
| ADJUST THE WAVEFORM (MODIFY)..... | 46 | | |
| ADDING EFFECTS | 47 | | |
| SHOWING CURRENT SETTINGS | 47 | | |
| WHAT IS AN “OSCILLATOR?”..... | 47 | | |
| OSCILLATOR TYPES AND CHARACTERISTICS..... | 48 | | |
| COMBINING THE SECTIONS AND PARTS | 49 | | |
| SECTIONS AND KEYBOARDS | 49 | | |
| ALLOCATING THE SECTIONS..... | 49 | | |
| KEYBOARD SPLIT | 49 | | |
| USING THE SPLIT FEATURE | 50 | | |
| CHANGING THE OCTAVE | 50 | | |
| PEDAL TO LOWER | 50 | | |
| PEDAL SUSTAIN..... | 50 | | |
| ADJUSTING THE SOUND DURING PERFORMANCE..... | 51 | | |
| REVERB | 51 | | |
| MASTER EQUALIZER | 51 | | |
| ADJUSTING THE MASTER EQUALIZER | 52 | | |
| TRANSCOPE, TUNE | 53 | | |
| TRANSPOSING THE ENTIRE KEYBOARD | 53 | | |
| MASTER TUNE..... | 54 | | |
| RECORDING SETTINGS..... | 55 | | |
| HOW TO RECORD | 55 | | |
| USING THE CONTROL PANEL..... | 56 | | |
| USING THE DISPLAY | 56 | | |
| PLAY MODE..... | 57 | | |
| PLAY MODES | 57 | | |
| HOW TO READ THE DISPLAY (Combination)..... | 57 | | |
| HOW TO READ THE DISPLAY (ORGAN Section)..... | 58 | | |
| HOW TO READ THE DISPLAY (PIANO/ENSEMBLE Section)..... | 58 | | |
| HOW TO READ THE DISPLAY (MONO SYNTH Section) | 59 | | |
| APP MENU..... | 59 | | |
| MENU MODE | 60 | | |
| HOW TO READ THE DISPLAY | 60 | | |
| OPERATION IN THIS MODE..... | 60 | | |
| MENU Mode CONTENTS | 61 | | |
| FUNCTION MODE..... | 62 | | |

All product names mentioned in this document are trademarks or registered trademarks of their respective owners.

NAMES AND FUNCTIONS

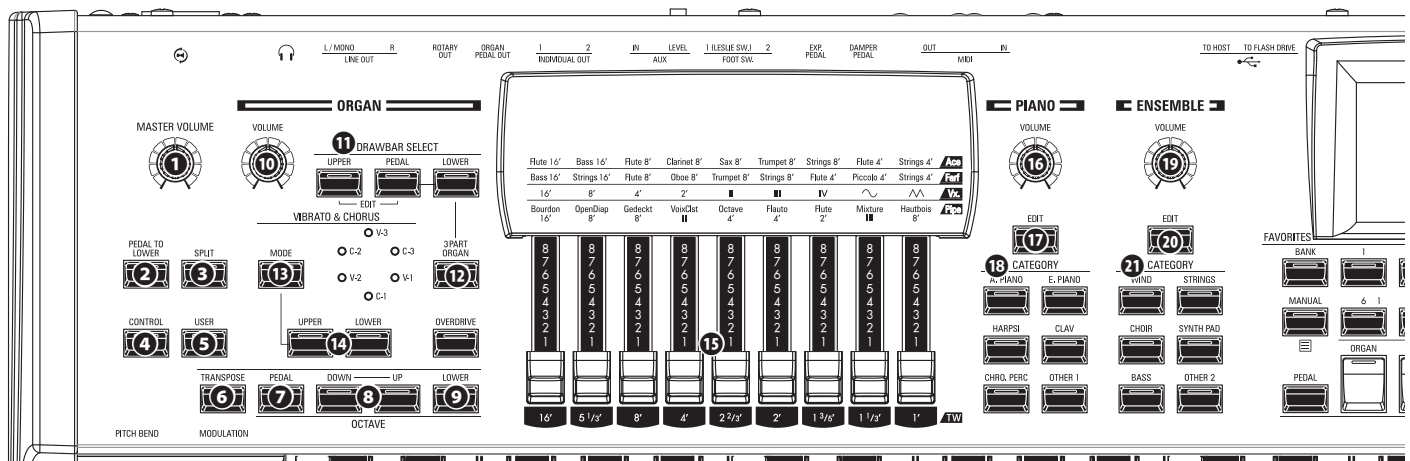

TOP PANEL

LEFT-HAND SIDE

- 1 MASTER VOLUME knob**
Controls the volume of the entire instrument.
- 2 PEDAL TO LOWER button**
Couples the entire Pedal registration, including Parameters, to the Lower Manual (P. 50).
- 3 SPLIT button**
Divides the keyboard into Upper (right) and Lower (left) keyboards (P. 49).
- 4 CONTROL button**
Accesses a feature from the CONTROL Menu.
- 5 USER button**
Displays a user-assignable Menu Page.
- 6 TRANSPOSE button**
Transposes the musical pitch of the entire keyboard when used in conjunction with **8** (P. 53).
- 7 OCTAVE PEDAL button**
Moves the Pedalboard pitch "UP" or "DOWN" by octaves when used in conjunction with the [UP] or [DOWN] buttons **8**.
- 8 OCTAVE DOWN/UP buttons**
Moves the UPPER Keyboard pitch "UP" or "DOWN" +/- 2 octaves (P. 50).
- 9 OCTAVE LOWER button**
Moves the LOWER Keyboard pitch "UP" or "DOWN" +/- 2 octaves when used in conjunction with the [UP] or [DOWN] buttons **8**.

ORGAN SECTION

- 10 ORGAN VOLUME knob**
Controls the entire volume of the ORGAN Section (P. 26).
- 11 DRAWBAR SELECT buttons**
 1. Select which ORGAN Part the Harmonic Drawbars **15** will affect (P. 28).
 2. Match the Drawbar Registration contained in a Patch with the physical Drawbar setting (P. 40).
 3. Opens the editing page of the ORGAN Section ([UPPER] and [PEDAL] buttons pressed together).

- 12 3 PART ORGAN button**
Converts the ORGAN Section to a two-manuals-and-pedals Hammond Organ (P. 31).
- 13 VIBRATO & CHORUS MODE button**
Selects the depth of either the Vibrato or Chorus (P. 29).
- 14 VIBRATO UPPER, LOWER button**
Turns the Vibrato/Chorus "ON" or "OFF" for the Upper or Lower ORGAN Part (P. 29).
- 15 HARMONIC DRAWBARS**
Registers the ORGAN Section (P. 33).
- 16 UPPER PERCUSSION buttons**
Adds Harmonic Percussion (decay) to the Upper Part of the ORGAN Section (P. 29).

PIANO / ENSEMBLE SECTION

- 16, 19 VOLUME knob**
Controls the volume of the Section (P. 42).
- 17, 20 EDIT button**
Opens the Edit Menu for the Section.
- 18, 21 CATEGORY button**
Selects the Voice Category of the Section (P. 41).

ALLOCATE

- 22 PEDAL button**
Allocates a Voice Section to the Pedalboard when used in conjunction with the PEDAL button **23** (P. 49).
- 23 SECTION buttons**
Allocates each Voice Section to the UPPER Keyboard (P. 49).
- 24 LOWER button**
Allocates a Voice Section to the LOWER Keyboard when used in conjunction with the LOWER button **23** (P. 49).

FAVORITES

- 26 BANK button**
Selects Favorite Banks by pressing and holding this button with one of the Favorite Number buttons.
- 27 MANUAL/APP button**
 1. Overrides the current Combination setting in favor of the current Panel settings (P. 24).
 2. Opens the Application Menu.

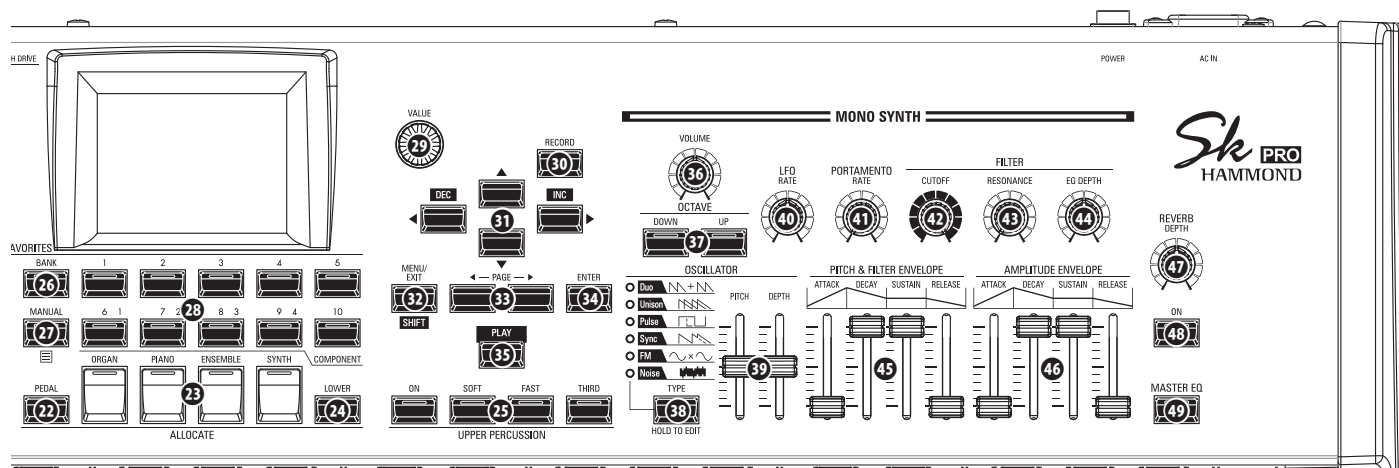

28 NUMBER buttons

Recalls a Favorite related to the numbered button.

CONTROL PANEL

29 VALUE knob

Increases or decreases Combination/Patch numbers while performing, or adjusts values during editing.

30 RECORD button

Allows you to record user-definable features such as Combinations, Patches, Custom parameters etc (P. 55).

31 DIRECTION / DEC / INC buttons

1. Moves the cursor in the display.
2. Increments or decrements a value while pressing and holding the [SHIFT] button 32.

32 MENU / EXIT / SHIFT button

1. Opens the MENU Edit page (P. 60).
2. Exit or back one level from current Menu Page.
3. Allows alternate functions for designated buttons.

33 PAGE buttons

Navigate the Edit Menu Pages.

34 ENTER button

Allows you to confirm the current entry or procedure when editing sounds or features.

35 PLAY button

Returns to the PLAY Mode.

MONO SYNTH SECTION

36 VOLUME knob

Controls the volume of the MONO SYNTH Section (P. 44).

37 SYNTH OCTAVE DOWN/UP buttons

Moves the musical pitch of the MONO SYNTH Section "UP" or "DOWN" by one octave (P. 44).

38 OSCILLATOR TYPE button

1. Selects the Oscillator Type (P. 46).
2. Opens the MONO SYNTH Edit Menu when pressed and held.

39 OSCILLATOR PITCH, DEPTH knob

Modifies the selected Oscillator waveform (P. 46).

40 LFO RATE knob

Adjusts the rate of the Low Frequency Oscillator (P. 46).

41 PORTAMENTO RATE knob

Adjusts the rate of the Portamento feature (P. 46).

42 FILTER CUTOFF knob

Selects the frequency at which the filter begins to have an effect on the waveform's frequency components (P. 46).

43 FILTER RESONANCE knob

Emphasizes the portion of the sound in the region of the cutoff frequency.(P. 46).

44 FILTER EG DEPTH knob

Adjusts the depth of the filter envelope 45 (P. 46).

45 PITCH & FILTER ENVELOPE sliders

Adjusts the changing over time of the pitch and filter (P. 46).

46 AMPLITUDE ENVELOPE sliders

Adjusts the changing over time of the amplitude or volume (P. 46).

RIGHT-HAND SIDE

47 REVERB DEPTH knob

Adjusts the depth of the Reverb effect (P. 51).

48 REVERB ON button

Turns the Reverb effect "ON" or "OFF" (P. 51).

49 MASTER EQ button

Turns the Master Equalizer. "ON" or "OFF" (P. 51).

LEFT SIDE OF THE KEYBOARD

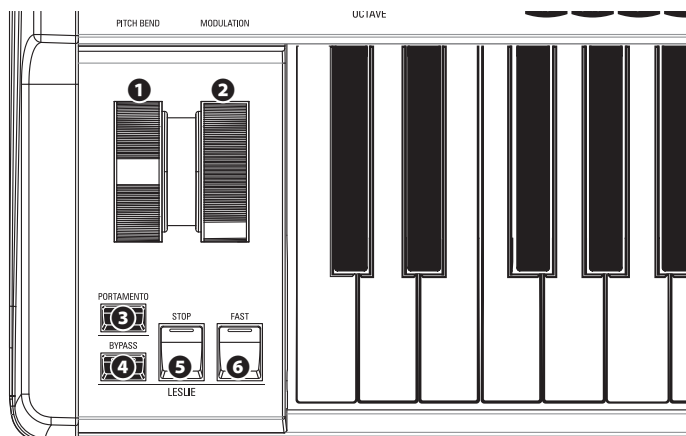

WHEELS

- 1 PITCH BEND wheel**
Bends the pitch of played notes “UP” or “DOWN” (P. 23).
- 2 MODULATION wheel**
Applies modulation to played notes (except ORGAN Section) (P. 23).

PORTAMENTO

- 3 PORTAMENTO button**
Turns the PORTAMENTO “ON” or “OFF” (P. 23).

LESLIE

- 23 LESLIE BYPASS button**
Channels the sounds produced by the ORGAN Section from the Rotary channel to the Stationary channel (P. 30).
- 24 LESLIE STOP button**
Stops the Leslie Rotors from turning when the [FAST] button is “OFF” (P. 30).
- 25 LESLIE FAST button**
Selects “FAST” Leslie Rotor speed (P. 30).

REAR PANEL

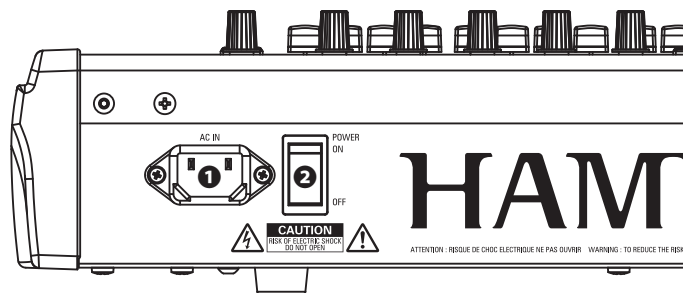

POWER

- 1 AC POWER RECEPTACLE**
Connect the female end of a grounded AC Power Cord here, and the male end into a grounded A.C. power outlet.
- 2 POWER switch**
Turns the AC power to the instrument “ON” or “OFF.”

AUDIO OUTPUT JACKS

- 3 PHONES jack**
Use this jack to connect a set of stereo headphones.
NOTE: Connecting Headphones does NOT mute the LINE OUT or LESLIE audio outputs. If you wish the sound to go through the Headphones only, disconnect all other audio outputs.
- 4 LINE OUT L/MONO jack**
LINE OUT R jack
Use these jacks to connect external audio equipment. If the connected mixer or monitor speaker is stereophonic, connect both the L and R jacks. If monaural, connect only to the L/MONO jack.
- 5 LESLIE® LESLIE 11 -PIN socket**
Use to connect a Leslie Speaker cabinet having an 11-pin interface.
When a Leslie Speaker cabinet is detected at via the 11-pin socket, the inbuilt digital Leslie Simulator is disabled at the PHONES jack and the LINE OUT jacks (P. 14).
- 6 ROTARY OUT jack**
Outputs the Rotary Channel of the ORGAN Section. Use this jack to bypass the inbuilt digital Leslie if you want a “dry” audio output from the ORGAN Section.
NOTE: Set the “ROTARY OUT” switch in the AUDIO portion of the FUNCTION Mode “Used” if you use this jack (P. 15).
- 7 ORGAN PEDAL OUT jack**
Outputs the Pedal Part of the ORGAN Section. Use this jack to connect a powered sub-woofer to increase the bass, or to bypass the Leslie effect to the Pedal Part (P. 15).
- 8 INDIVIDUAL OUT 1 jack**
INDIVIDUAL OUT 2 jack
Outputs the specified Section independently (P. 16).

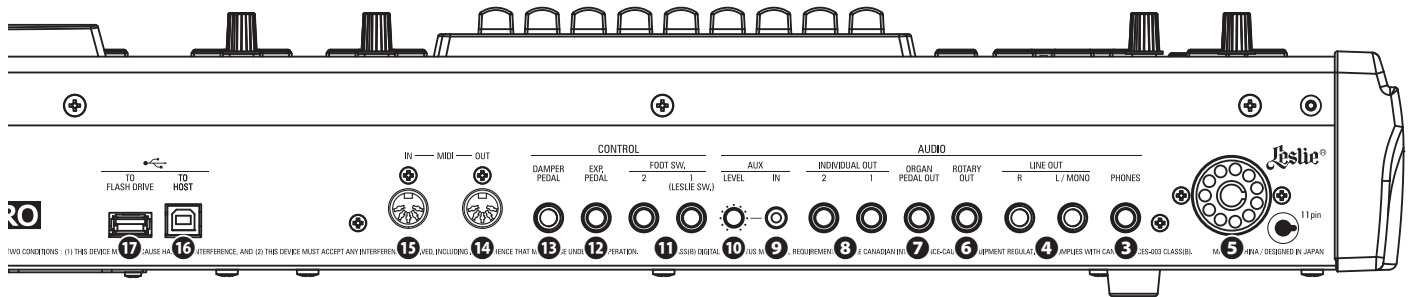

AUDIO INPUT JACK

9 AUX IN jack

Use this jack to connect an external audio source. When connected, the sound will be mixed with the internal keyboard sounds and sent out to the LINE OUT jacks and the Stationary channel of a multi-channel Leslie Speaker via the 11-pin socket (P. 16).

10 AUX LEVEL knob

Adjusts the volume of the sound coming in from the AUX IN jack.

CONTROLLER JACKS

11 FOOT SWITCH 1 jack

FOOT SWITCH 2 jack

Use these jacks to connect Foot Switches to switch the Leslie effect or change Combinations.

The recommended Foot Switches are listed below;

HAMMOND... FS-9H, VFP1

BOSS FS-5U

YAMAHA..... FC4A, FC5

In addition, the FS-10TL Leslie Switch (not available in Europe) can be connected to the FOOT SWITCH 1 jack.

12 EXP. PEDAL jack

Use this jack to connect an Expression Pedal to control volume while playing.

The recommended Expression Pedals are listed below:

HAMMOND... EXP-50J, EXP-20, V-20H, V-20R; NORM

KORG..... XVP-10, XVP-20; REV

ROLAND EV-5; NORM

YAMAHA..... FC7; REV

13 DAMPER PEDAL jack

Use this jack to connect a Damper Pedal (Sustain Pedal) for holding notes when keys are played and released.

The recommended Damper Pedals are listed below:

HAMMOND... FS-9H, VFP1

ROLAND DP-10

YAMAHA..... FC3A, FC4A, FC5

MIDI PORTS

14 MIDI OUT port

Transmits MIDI data to a connected MIDI device.

15 MIDI IN port

Receives MIDI data from a connected MIDI device. This port can be programmed for a LOWER Keyboard or a Pedalboard.

USB PORTS

16 USB TO HOST port

Use to connect to a computer to transmit MIDI messages or Load and Save files such as Setups or Update files.

17 USB FLASH DRIVE port

Use to connect a USB Flash Drive to Load or Save files such as Setup or Update files.

KEYBOARD

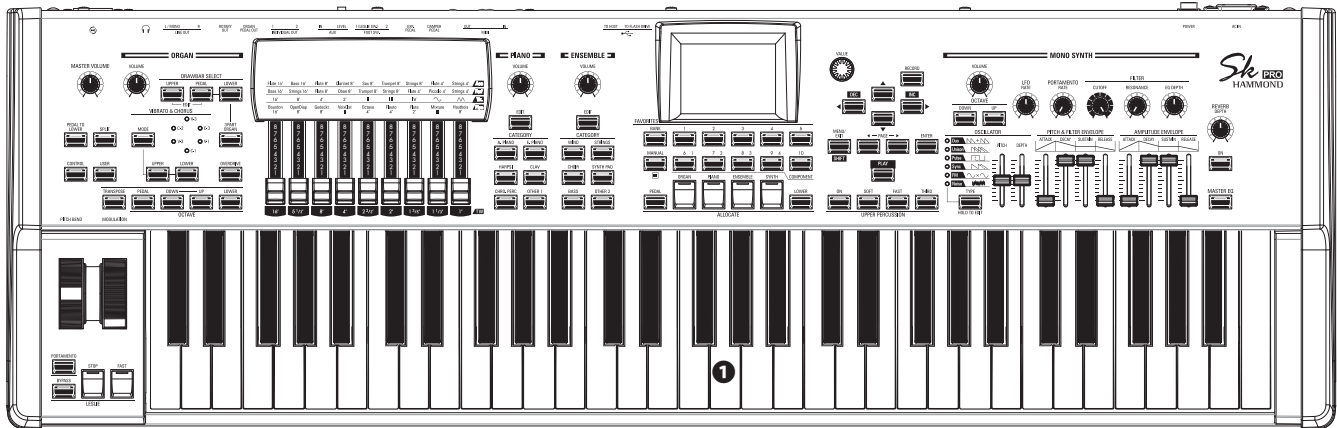

1 Keyboard

61 notes (SK PRO) / 73 notes (SK PRO-73), square-front (“waterfall” type), semi-weighted, velocity-sensitive keyboard.

ACCESSORY

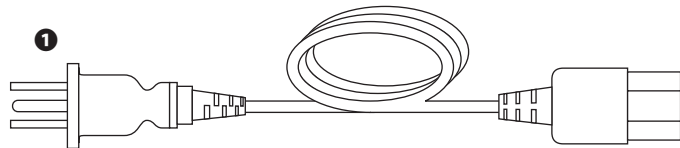

1 AC Power Cord

Connects to the AC Power Receptacle of the SK PRO/SK PRO-73.

ACCESSORIES (SOLD SEPARATELY)

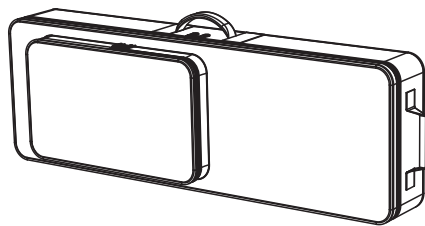

Soft Case (SC-61KC, SC-73KC)

Light-weight carrying case, can be held with both hands or put over the shoulder. Additional pocket for storing music, Foot Switches, Expression Pedal, etc.

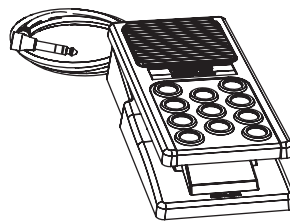

Expression Pedal EXP-20

Light weight for touring usage.

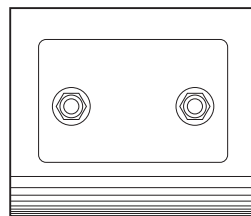

**Leslie Switch FS-10TL
(not available in Europe)**

Controls both the [ON/OFF] and [SLOW/FAST] of the Leslie Rotors.

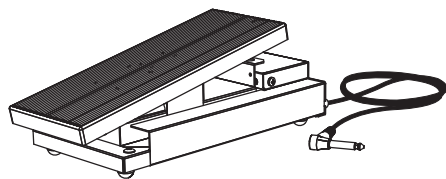

Expression Pedal EXP-50J

Heavyweight pedal for durability, and detachable cable to avoid breaking or fraying.

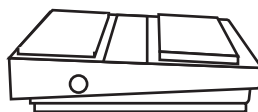

Foot Switch FS-9H

Multi-purpose foot switch with Momentary action.

BASIC CONNECTIONS

Connect audio cables and accessories as shown below.

The SK PRO/SK PRO-73 is not self-contained - an external amplifier/speaker system is required in order to hear the sound. However, if you connect a set of stereo headphones to the PHONES jack, you can hear the sound through the headphones even if an external amplifier is not connected.

NOTE: Be sure that both the instrument and amplifier are "OFF" before connecting amplifiers or headphones.

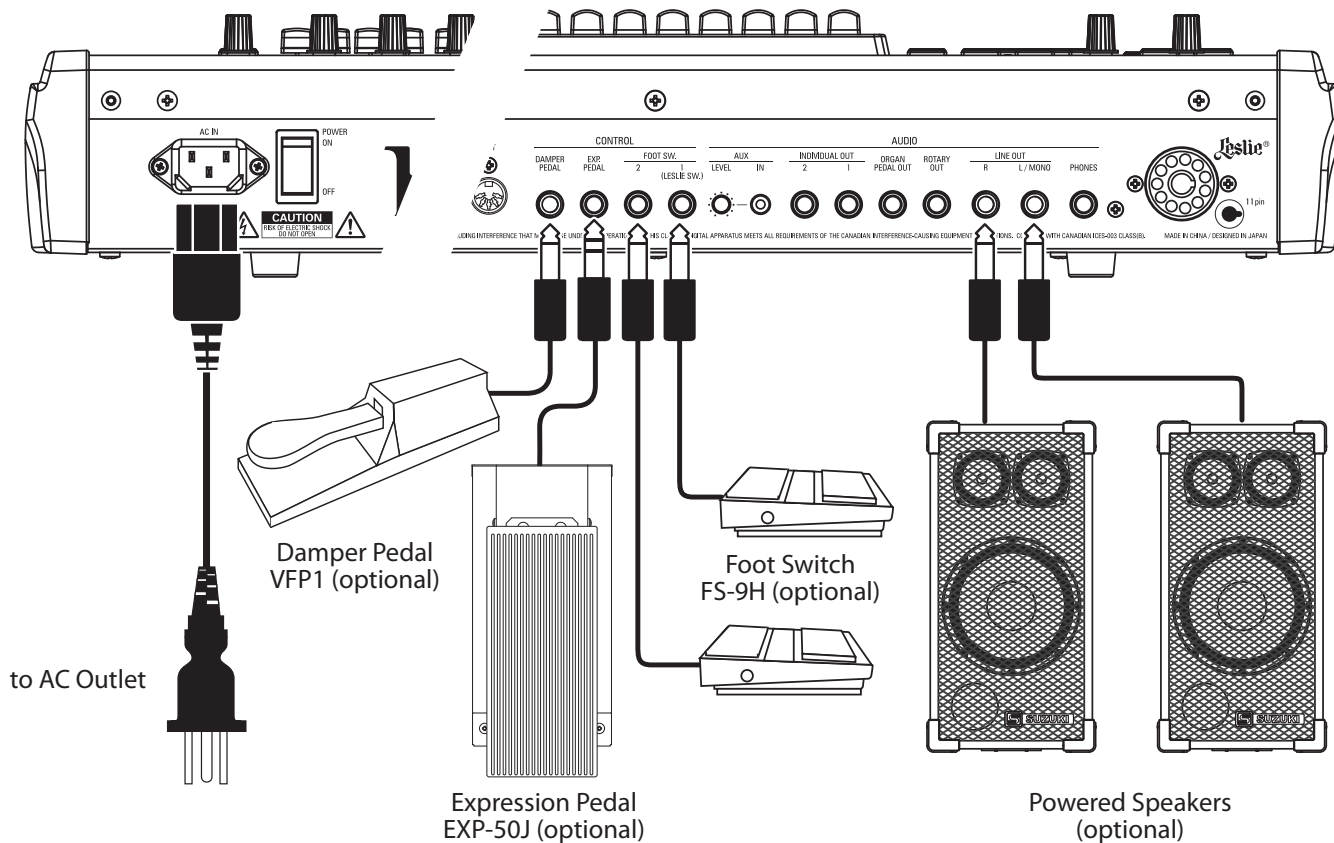

NOTE: The Expression Pedal, Foot Switch and Damper Pedal parameters must be set properly. This is explained more fully in the Owner's Manual.

⚠ CAUTION

This instrument draws a slight amount of power even if the [POWER] switch is "OFF." Therefore, if the instrument will not be used for a long period of time, disconnect the AC plug from the outlet.

Do not place this keyboard in direct sun light, near heat sources, or in a hot location.

CONNECTING A LESLIE SPEAKER

A Leslie Speaker cabinet with an 11-pin interface can be directly connected to the SK PRO/SK PRO-73.

NOTE: Be sure the power to the SK PRO is "OFF" before connecting the Leslie speaker.

Connecting a single-channel Leslie speaker

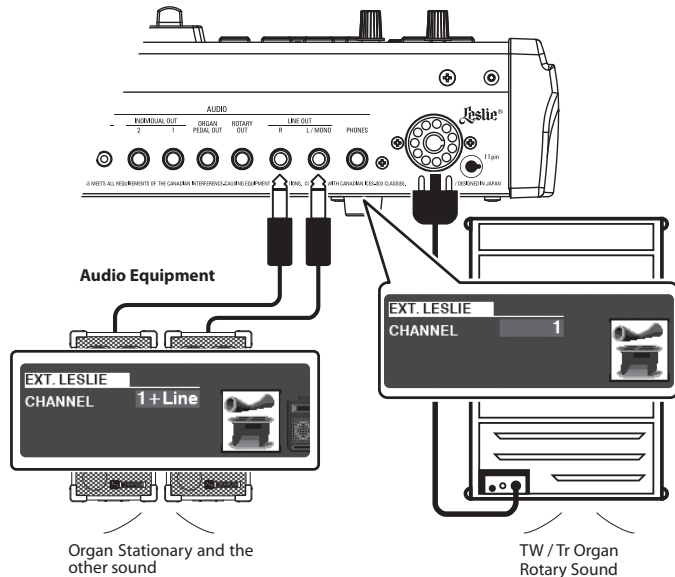

Connecting a 3-channel Leslie speaker

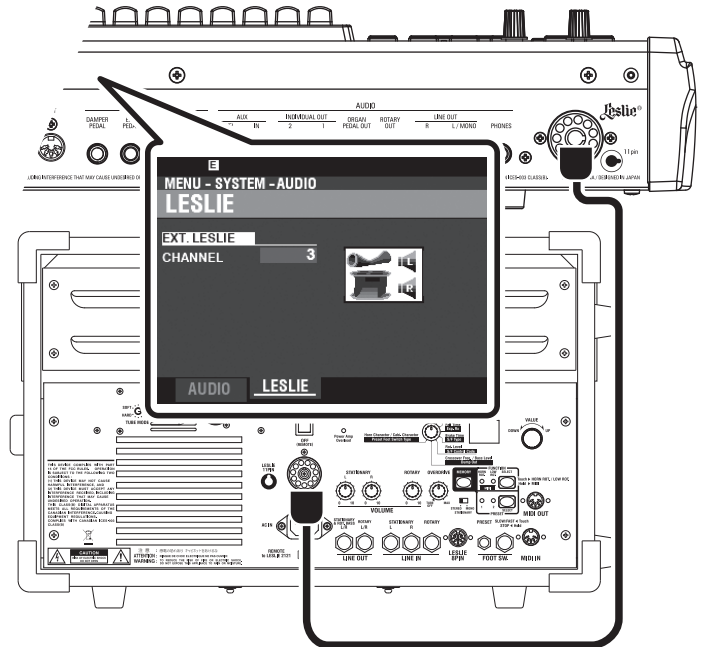

BASIC CONNECTION

3-CHANNEL TYPE (2101/2101mk2/2103mk2)

1. Connect the SK PRO to the Leslie Speaker via an 11-pin Leslie cable (optional LC-11-7M, not included).
2. Turn the power to the SK PRO "ON" and set the EXT. LESLIE CH parameter to "3."
3. Make sure a Hammond Drawbar ORGAN Type ("A-100," "B-3," "C-3," or "Mellow") is selected.
4. Press the [BYPASS] button "ON" and set the [STATIONARY VOLUME] of the Leslie Speaker at a desired level.
5. Press the [BYPASS] button "OFF" while playing, and set the [ROTARY VOLUME] of the Leslie Speaker at the same audible level as the [STATIONARY] Channel.

SINGLE-CHANNEL TYPE (122XB, 981, 3300/W)

1. Connect the SK PRO to the Leslie Speaker via an 11-pin Leslie cable (optional LC-11-7M, not included). This will allow you to hear the Drawbar ORGAN sounds.
2. Connect the SK PRO to a keyboard amp or powered speakers via 1/4" audio cables from the LINE OUT jacks of the SK PRO.
3. Turn the power to the SK PRO "ON" and set the EXT. LESLIE CH parameter at "1+LINE."
4. Make sure a Hammond Drawbar ORGAN Type ("A-100," "B-3," "C-3," or "Mellow") is selected.
5. Press the [BYPASS] button "ON" and set the audio equipment at a desired level.
6. Press the [BYPASS] button "OFF" and set the Volume of the connected Leslie Speaker at the same audible level as when the [BYPASS] button is "OFF."

tips LESLIE SPEAKERS TO BE CONNECTED

The SK PRO/SK PRO-73 is designed to connect with 3-channel Leslie speakers such as the 2101/2101mk2/2103mk2. It is also possible to connect a single-channel Leslie speaker such as a 122XB, 981 or 3300/W; however, a single-channel Leslie will reproduce the Drawbar ORGAN sounds only. To hear the PIANO/ENSEMBLE/SYNTH voices, connect an additional sound source such as a keyboard amp or powered speakers via the LINE OUT jacks.

tips LESLIE CHANNEL

3-channel type Leslie speakers are equipped with a stereo speaker system, independent of the Rotary channel, to provide stereo sound for the Rotary (ORGAN) channel and the Stationary (PIANO, ENSEMBLE and MONO SYNTH) channel.

A traditional single-channel Leslie speaker, such as a #122, #981 or #3300 has no stationary speaker system, thus requiring a separate amplifier/speaker for other sounds such as PIANO, ENSEMBLE and MONO SYNTH.

OUTPUT DRY ORGAN SOUNDS

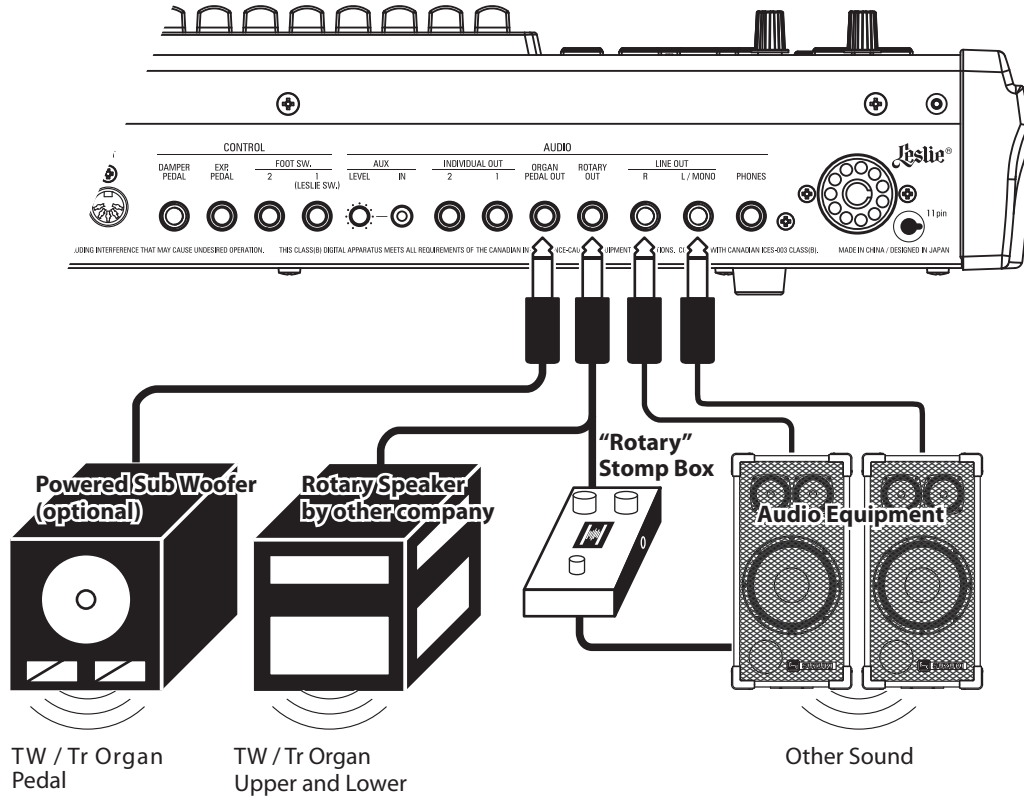

ROTARY OUT jack

Use the [ROTARY OUT] jack if you want to output a “dry” organ signal without the inbuilt digital Leslie effect.

NOTE: Set the “ROTARY OUT” switch in the AUDIO FUNCTION Mode at “Used” when using this jack to mute the ORGAN Section from the [LINE OUT] jacks. This is explained more fully in the Owner’s Manual.

ORGAN PEDAL OUT jack

This jack outputs the Pedal Part of the ORGAN Section.

Connect the [ORGAN PEDAL OUT] jack to a powered sub-woofer if you want to reinforce the bass or bypass the Leslie effect to the Pedal Part.

NOTE: Set the “USE PEDAL OUT” switch in the AUDIO FUNCTION Mode at “Used” when using this jack to mute the Pedal Part from the [LINE OUT] jacks.

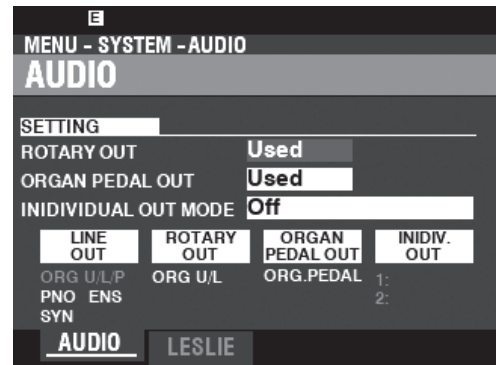

USING AN EXTERNAL MIXER

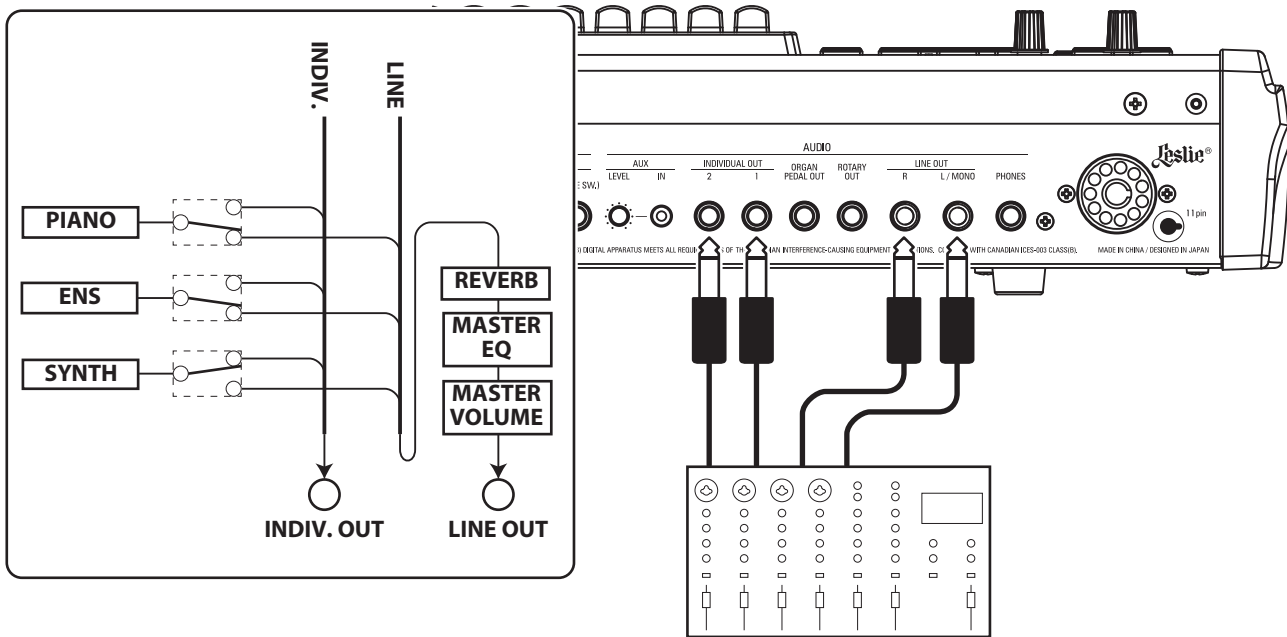

INDIVIDUAL OUT jacks

Use the [INDIVIDUAL OUT] jacks to connect an external mixer or add effects from external effects devices. You can choose the Voice Section which will be present at each of these jacks.

NOTE: Use the "INDIVIDUAL OUT" switch in the AUDIO portion of the FUNCTION Mode to select the Sections to assign to the [INDIVIDUAL OUT] jacks. This is explained more fully in the Owner's Manual.

NOTE: If a Voice Section is assigned to an [INDIVIDUAL OUT] jack, it will not be muted from the [LINE OUT] jacks.

NOTE: The sound from the [INDIVIDUAL OUT] jacks is not affected by Reverb, the Master Equalizer, or the [MASTER VOLUME] knob.

NOTE: The ORGAN Section cannot be assigned to the INDIVIDUAL OUT jacks.

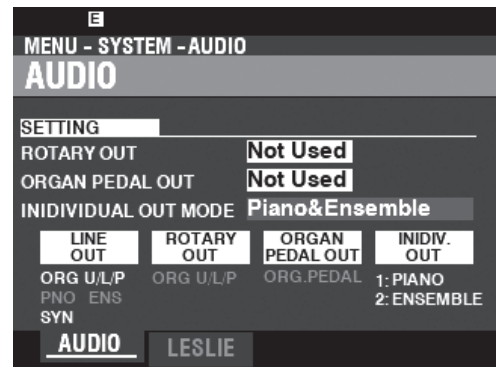

USING A MUSIC PLAYER

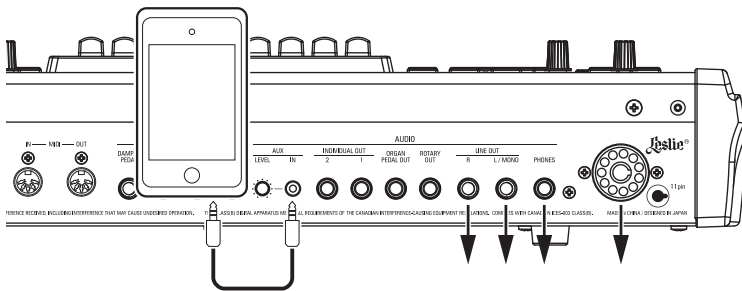

AUX IN jack

Use the [AUX IN] jack to connect a music player or phone.

Use the [AUX LEVEL] knob on the Rear Panel to control the volume of a device connected via the [AUX IN] jack.

The audio signal via the [AUX IN] jack will combine with the output from the [LINE OUT] jacks, [PHONES] jack and the Stationary Channel of the 11-pin Leslie socket.

NOTE: The [MASTER VOLUME] knob does not affect the audio signal coming into the [AUX IN] jack.

The SK PRO/SK PRO-73 can be expanded by connecting an external keyboard and/or a pedalboard.

DUAL MANUAL OPERATION

You can use an external MIDI keyboard with the SK PRO in two ways (shown below):

- Use the SK PRO and an external MIDI keyboard for UPPER and LOWER Keyboards without using SPLIT.
- Play a specified Section, such as PIANO, via external MIDI keyboard while retaining a SPLIT on the SK PRO.

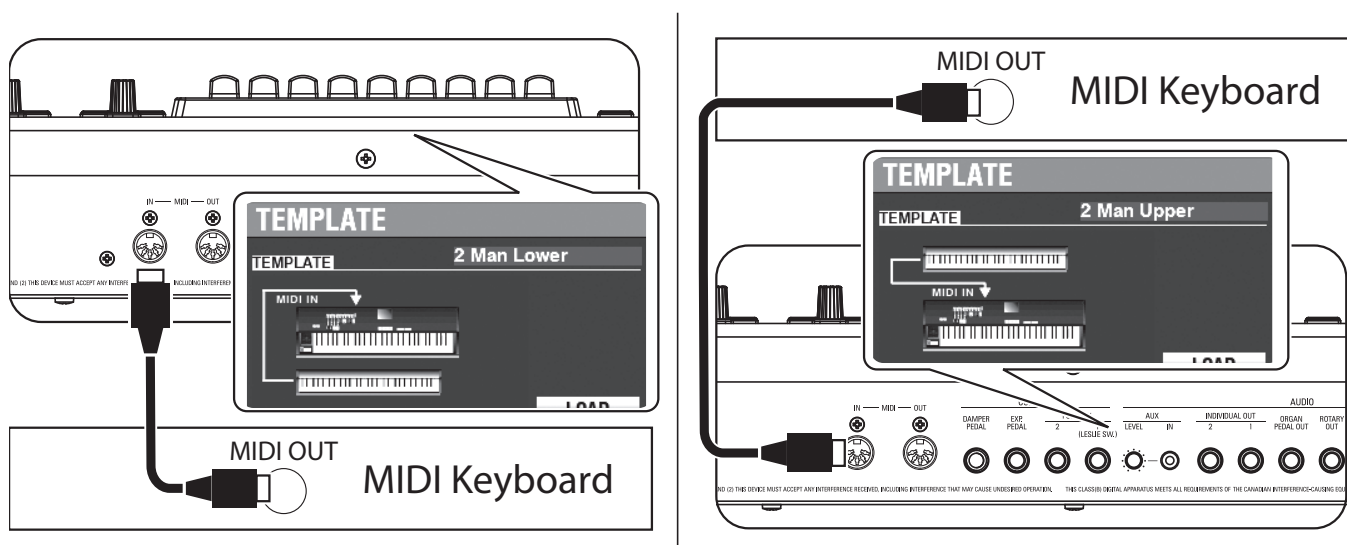

In order to use an external MIDI keyboard, you will have to connect it via MIDI. You will also have to select a **MIDI Template**, which is a preselected set of MIDI parameters designed for specific MIDI applications.

To use an external MIDI keyboard with the SK PRO, do the following:

1. Connect an external MIDI keyboard as shown above.
2. Turn the power to the SK PRO “ON” and press the MENU\EXIT button to enter MENU Mode.
3. Press the [PAGE ►] button two times to display the SYSTEM Menu.
4. Press the [DIRECTION ►] button once to select MIDI.
5. Press the [ENTER] button. You will see the MIDI TEMPLATE Menu.
6. Use the [VALUE] knob to select the MIDI Template for the type of playing you want to do.

2 Man Lower The internal keyboard works as Upper, and the MIDI keyboard works as Lower.

Piano The internal keyboard works as Upper and Lower, the MIDI keyboard sounds PIANO Section only.

For more specific information about the connected MIDI keyboard, please refer to its Owner’s Manual.

TWO MANUALS + PEDALBOARD

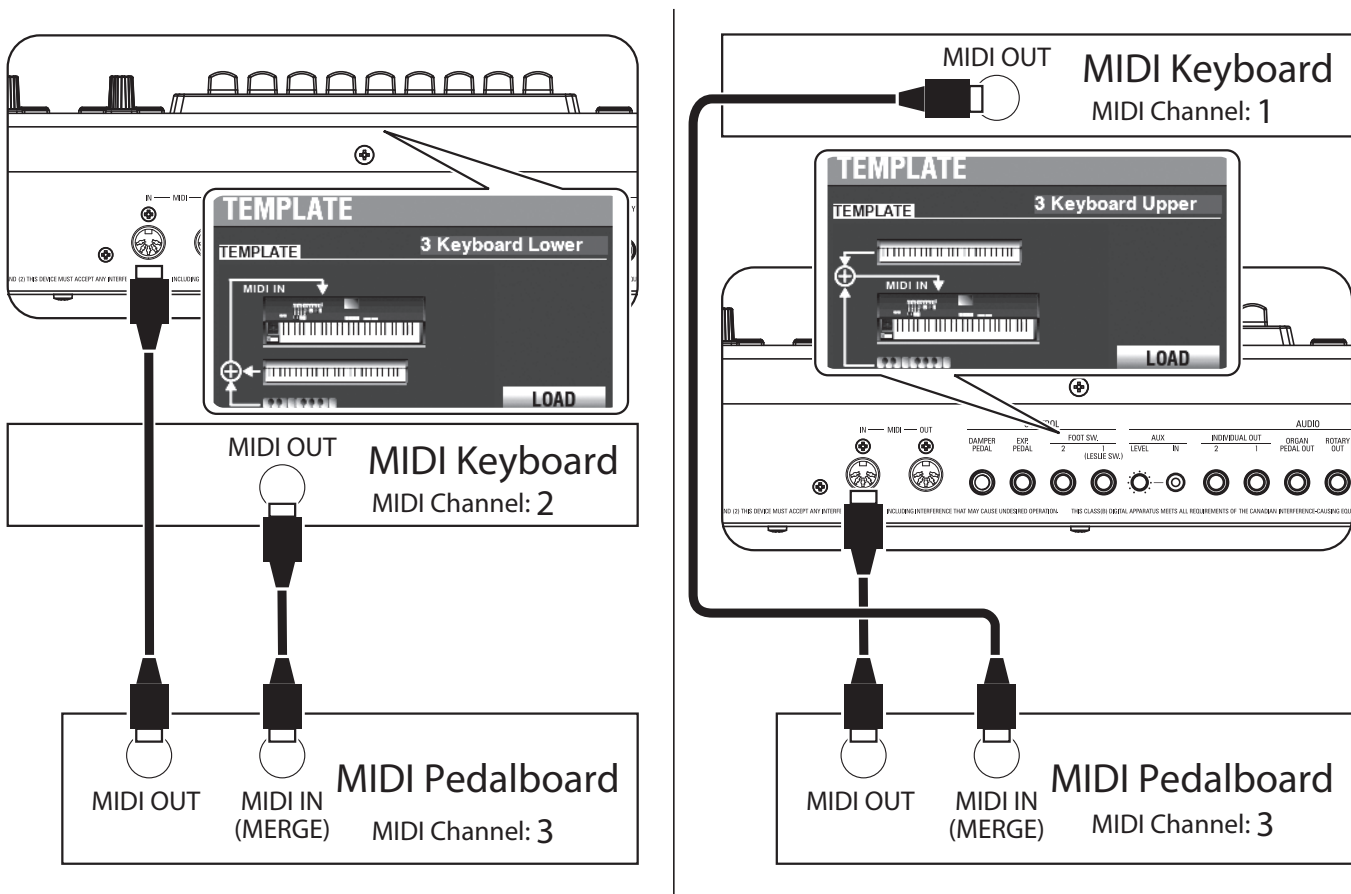

1. Connect as illustrated above. The SK PRO has one MIDI IN port; therefore a MIDI keyboard with a merge function or a MIDI Merge-box is necessary for a dual keyboard configuration.
2. Turn the power to the SK PRO/SK PRO-73 "ON."
3. Select MIDI Template "3KBD Upper" or "3KBD Lower."
4. Set the Transmit channel of the added MIDI keyboard at "2" if you are using it as a Lower Keyboard, or "1" if you are using it as a UPPER Keyboard. If you are using a MIDI Pedalboard, set its Transmit Channel at "3."

NOTE: Hammond MIDI Pedalboards are automatically set to transmit on MIDI Channel 3.

RECOMMENDED MIDI PEDALBOARDS

The following HAMMOND MIDI Pedalboards are recommended for use with the SK PRO/SK PRO-73:

- MIDI Sound Pedalboard XPK-130G (13 notes)
- MIDI Sound Pedalboard XPK-200G (20 notes)
- MIDI Sound Pedalboard XPK-200GL (long 20 notes)

NOTE: The SK PRO/SK PRO-73 can also be used with the following Hammond MIDI Pedalboard models:

XPK-100, XPK-200, XPK-200L.

tips HOW A MIDI KEYBOARD WORKS

On the SK PRO, a connected MIDI keyboard functions as a "LOWER" Keyboard when the MIDI Template is set for "3KBD" or "Two Manual." On the SK PRO-73, a connected MIDI keyboard functions as an "UPPER" keyboard when the MIDI Template is set for "3KBD" or "Two Manual."

POWERING ON

19

After making the connections described on the previous pages, you are ready to turn the SK PRO power “ON.” Follow the procedure below to prevent malfunction or damage.

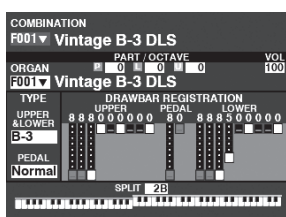
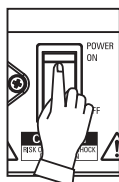
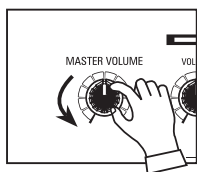

TURNING THE POWER “ON”

1. Before turning the power to the SK PRO “ON,” make sure you have connected all peripherals (Expression Pedal, Foot Switch(es), etc.) properly. Also be sure to set the [MASTER VOLUME] Rotary Knob to its minimum setting.

NOTE: The polarity of each Foot Controller will be detected automatically.

2. The Power Switch is located on the left side of the Accessory Panel (right side facing the keyboard). Turn the power to the instrument “ON.” The display will show, “Loading...” below the opening screen for approximately 35 seconds while the system software loads, then the PLAY Mode screen will display.

NOTE: If you have a Leslie Speaker connected to the instrument, the Leslie will turn “ON” automatically.

NOTE: In order to protect the circuits, the SK PRO will be ready to play approximately 6 seconds after the power is turned “ON.”

3. Turn the power to the connected amplifier “ON.”

4. Hold down a playing key and turn the [MASTER VOLUME] to the right a little and play some notes on the keyboard. Adjust the [MASTER VOLUME] as needed.

NOTE: If the [MANUAL] button is pressed in the Default setting and the [ALLOCATE] buttons are all “OFF,” no sound will be heard. You can touch any of the [ALLOCATE] buttons or select any of the [FAVORITE] ([1] to [10]) buttons to hear sounds.

5. Adjust the volume of the amplifier.

NOTE: To turn the SK PRO power “OFF,” reverse the above procedure. Also, be sure to turn the power to a connected amplifier “OFF” before turning the keyboard “OFF.” This will prevent a loud “pop” from the amplifier.

BACKING UP THE INITIAL SETTINGS

The SK PRO does not remember the status of the playing controls before the power is turned “OFF.” The status of the default settings are the same as when the [1] Favorite button is depressed.

AUTO POWER OFF

The SK PRO has an “AUTO POWER OFF” feature which will automatically turn the power to the instrument “OFF” if no keys or buttons are pressed for 30 minutes.

NOTE: Depending on the status of the instrument - while editing, for example - the power may not turn “OFF” even if AUTO POWER OFF is enabled. Therefore, it is best to turn the SK PRO power “OFF” via the Power Switch after every use.

RESTORING THE FACTORY SETTINGS

To reset all parameters of the SK PRO to their default settings, do the following:

1. Turn the power to the SK PRO “OFF.”
2. Press and Hold the red [RECORD] button.
3. While holding the [RECORD] button, turn the [POWER] “ON.”
3. Continue to hold down the [RECORD] button. When “Loading Default” is displayed, release the [RECORD] button.
4. When the PLAY Mode is displayed, the factory settings have been restored.

STRUCTURE OF THE SK PRO

The diagram below show the structure of the sound engine and memory.

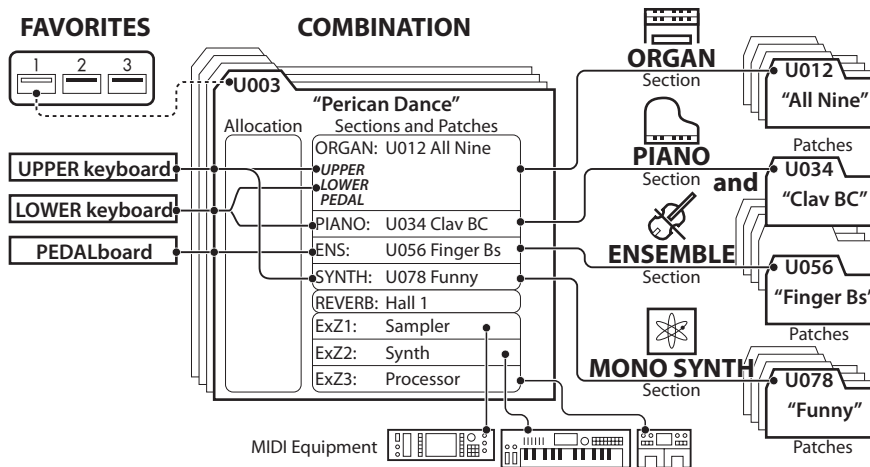

The SK PRO has four sound-producing divisions or **Sections**. Each Section has sounds and parameters which can be saved as a Patch. In addition, Patches from the different Sections can be combined to produce a Combination. This is explained in more detail starting below.

SECTIONS



There are four (4) sound Sections - ORGAN, PIANO, ENSEMBLE and MONO SYNTH. These can be used individually or together, as shown on the right side of the above diagram.

KEYBOARDS AND PARTS

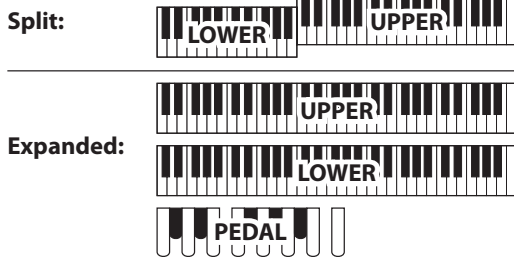

The SK PRO Voice Sections can be allocated either by using the SPLIT feature to divide the keyboard or by expanding the instrument via MIDI (see the figure above). When the SPLIT feature is enabled, the portion of the keyboard to the right of the Split point is called UPPER and the left portion of the keyboard is called LOWER. PEDAL refers to the bass tones which can be played from a connected MIDI Pedalboard.

PARTS

The ORGAN Section has 3 Parts - UPPER, LOWER and PEDAL. These can be assigned either by using the [ALLOCATE] buttons or, when using the [3 PART ORGAN] function, allocated to replicate the performance of a classic Hammond Organ with two manuals and pedals.

MEMORY

PATCHES

A **Patch** is an individual unit of each Voice Section. For example, the PIANO Section contains Grand Pianos, Electric Pianos, etc., the ENSEMBLE Section contains Strings, Choir, and so on.

FACTORY, USER and BUNDLE



The Patches are grouped in three ways. “F” (Factory) Patches are set at the factory and cannot be changed. “U” (User) Patches can be changed by the player. “B” (Bundles) record COMBINATION, ORGAN and MONO SYNTH Sections to new Patches.

There are 100 Factory and 100 User Patches for the ORGAN and MONO SYNTH Sections. The PIANO and ENSEMBLE Sections share a common library of 300 Factory Patches and 400 User Patches.

COMBINATIONS

A “Combination” is a unit which contains Patches as well as other parameters such as the Patch number of each Section, keyboard allocations of each Section, etc. (upper figure of this page, center).

The SK PRO contains a total of 100 Combinations which can be used “as is” or changed to suit the player.

For example, “ORGAN Section Patch #10, allocated to LOWER Keyboard, soft Volume, Octave +1, PIANO Section Patch #3, allocated to UPPER Keyboard at high Volume.”

FAVORITES

The [FAVORITE] buttons allows you to store and recall frequently-used Combinations (upper figure of this page, upper-left side).

There are 10 [FAVORITE] buttons. In addition, there are 10 Banks of Favorites, bring the total number of Favorites to 100. Use the [BANK] button to access the Favorite Banks.

Combinations are the basic memory units of the SK PRO. This is described in more detail starting below.

WHAT IS A “COMBINATION?”

As explained previously, the SK PRO has four sound-producing sections - ORGAN, PIANO, ENSEMBLE, and MONO SYNTH. These, along with other parameters such as Control Panel settings, etc., can be combined into a single unit called a **Combination**.

The SK PRO/SK PRO-73 comes with 100 pre-programmed Combinations. Starting below is an example of how to use Combinations.

SELECT A COMBINATION

① LOCATE THE PLAY MODE

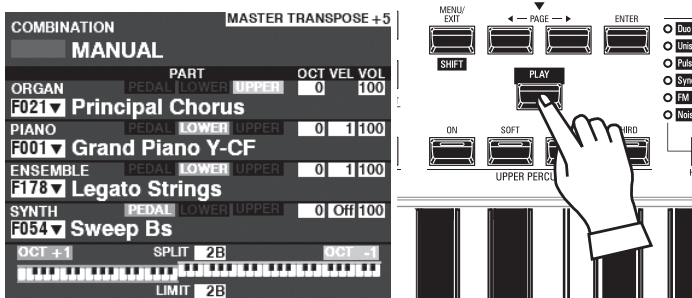

If the PLAY Mode is not displaying, press the [PLAY] button to display it.

② MOVE THE CURSOR TO THE COMBINATION NUMBER

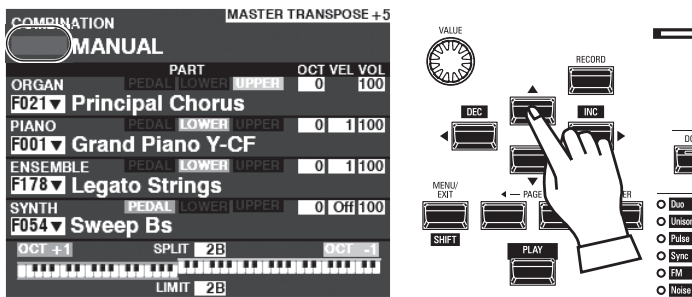

If the cursor is not at the Combination Number (very top of the screen), move the cursor to it using the direction buttons.

③ SELECT A COMBINATION

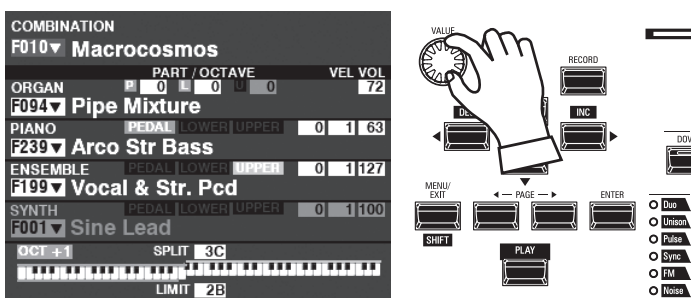

Use the [VALUE] knob to select a Combination.

NOTE: You can also select a Combination Number by direct numerical key input. This is explained more fully in the Owner's Manual.

tips THE “▼” INDICATES A LIST

The “▼” shown to the right side of the Combination Number indicates a list of available choices for that selected Voice Category. Use the “▲” and “▼” buttons to highlight the available Voices.

When you have highlighted the Voice you want, press the [ENTER] button to select it. Use the [VALUE] knob to select a Combination Number and press the [ENTER] button. The Voice has now been saved to the Combination and the list will close.

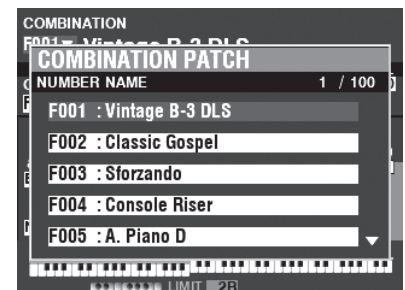

22 FAVORITES-FREQUENTLY USED COMBINATIONS

You can recall Combinations you frequently use by using the FAVORITES feature. This is explained in more detail starting below.

WHAT IS A "FAVORITE?"

A **Favorite** is simply a Combination which is stored to one of the 10 numbered buttons in the [FAVORITE]S section, allowing you to recall frequently used Combinations more quickly than using the [VALUE] knob.

BANK AND NUMBER

| Bank \ Number | 1 | 2 | 3 |
|---------------|-----------------|----------------|-----------------|
| 1 | U011 Born Verse | U012 Born Solo | U011 Born Verse |
| 2 | U024 MyLife Pf | U045 Lucy Org | U023 GetBack EP |
| 3 | P061 Classic | P062 Slow | P063 Contemp. |

There are 10 available Banks of Favorites, each of which contains 10 Favorites. This allows you to have 100 Combinations readily available to quick access. The chart above shows an example of compiling a **Set List** using different Favorite Banks.

LINKING A COMBINATION TO A FAVORITE

1 SELECT A COMBINATION

Select a Combination you want to link to a Favorite. For this example, link Combination F002 to Favorite #2, Bank #5.

2 SELECT A BANK

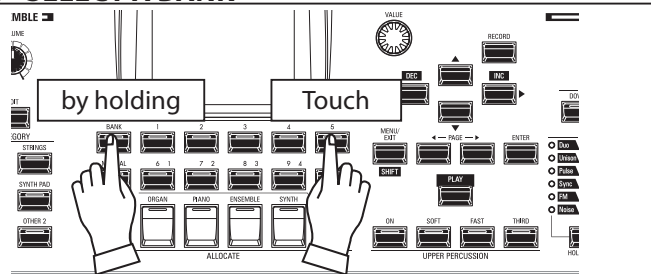

Select the Bank. For this example, select Bank 5. Press and Hold the [BANK] button and press the [5] [FAVORITE] button. The LED of the selected number will flash several times.

3 SELECT A NUMBERED [FAVORITE] BUTTON

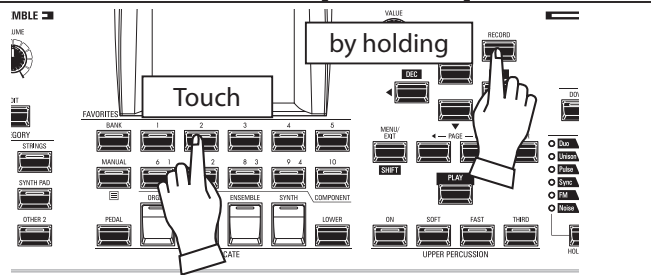

Select a Favorite Number. For this example, Press and Hold the [RECORD] button and press the [FAVORITE] [2] button. The LED of the numbered button will flash several times. When the LED stops flashing the procedure is complete and your Bank is selected.

RECALLING A COMBINATION USING A [FAVORITE] BUTTON

1 SELECT THE BANK

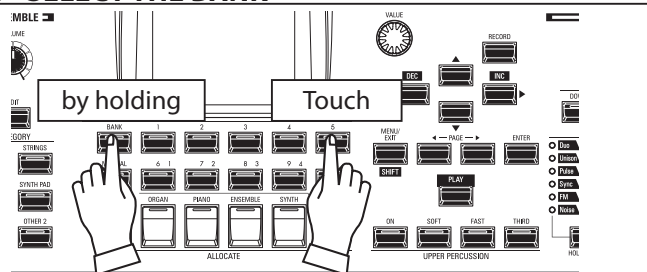

Press and Hold the [BANK] button and press the numbered [FAVORITE] button representing the Bank where the Combination you want to stored. The LED of the [FAVORITE] button will flash several times.

2 SELECT THE [FAVORITE] BUTTON

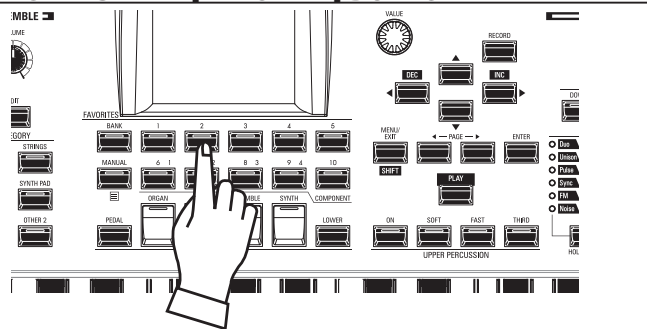

Press the numbered [FAVORITE] button where the Combination you want is stored. The LED of the numbered button will light and your Combination is selected.

NOTE: You can view a list of Favorites. This is explained more fully in the Owner's Manual.

tips CONFIRM CURRENT BANK

Press and Hold the [BANK] button to determine which Bank is selected. One of the numbered [FAVORITE] buttons will light indicating which Bank is currently active.

tips OMITTING BANK STEP

If the current Bank already contains the [FAVORITE] you want, you can omit Step 1 above.

The various Controllers of the SK PRO are explained in detail starting below.

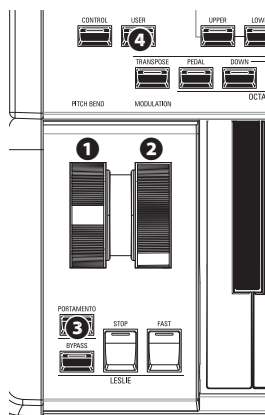

INTERNAL CONTROLLERS

1 PITCH BEND wheel

Allows you to bend the pitch “UP” or “DOWN” smoothly. Push the wheel away from you to bend the pitch “UP,” and pull it toward you to bend the pitch “DOWN.” When the wheel is released, it will automatically return to its center position.

2 MODULATION wheel

Allows you to add Vibrato or Modulation to the sound. Push the wheel away from you to increase the effect, and away from you to decrease the effect.

NOTE: The effects controlled by the wheels may be somewhat different for each Combination or Patch.

3 PORTAMENTO button

Allows you to turn the Portamento effect “ON” or “OFF.” When this button is “ON” and Portamento is enabled for a particular Patch, the pitch will glide smoothly from the last note played to the current note being played and held.

NOTE: The status of the PORTAMENTO button can be recorded to a Combination. This is explained more fully in the Owner’s Manual.

NOTE: PORTAMENTO can be applied to the PIANO, ENSEMBLE or MONO SYNTH Voices. This is explained more fully in the Owner’s Manual.

4 USER button

Allows you to assign a function for instant access.

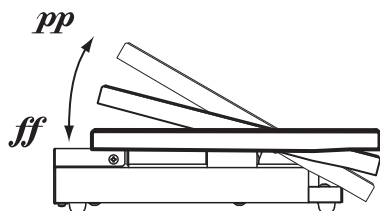

EXP-50J (optional)

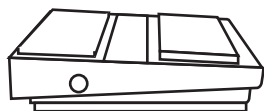

FS-9H (optional)

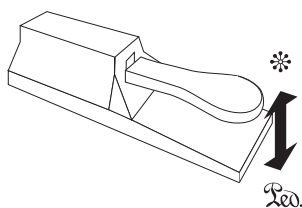

VFP1 (optional)

EXPRESSION PEDAL

You can use an Expression Pedal to control the overall volume of the SK PRO.

Press forward with the front of your foot to increase the volume and back with your heel to decrease the volume.

NOTE: You can also use the Expression Pedal to change dynamics. This is explained more fully in the Owner’s Manual.

NOTE: You can select whether or not the Expression Pedal will affect a particular Voice Section. This is explained more fully in the Owner’s Manual.

FOOT SWITCH

You can use a Foot Switch to control various functions - for example, switching Leslie rotor speeds.

NOTE: You can assign a Foot Switch to control various functions. This is explained more fully in the Owner’s Manual.

DAMPER PEDAL

You can use a Damper Pedal to hold or “damp” notes while it is pressed and held, similar to the damper pedal on an acoustic piano.

NOTE: You can assign the Damper effect to the Voice Section or Sections you wish. This is explained more fully in the Owner’s Manual.

The SK PRO incorporates an exclusive Hammond feature called **MANUAL**, which is explained starting below.

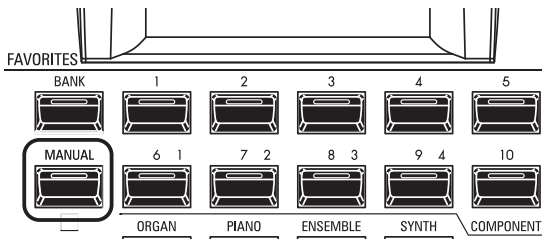

WHAT IS “MANUAL”?

Normally, one of the [FAVORITE] buttons is “ON” (LED lit), indicating that a Combination is selected. However, if you want to de-select Combinations and use the front panel controls entirely to control the sound, turn the [MANUAL] button “ON.” The [FAVORITE] buttons will all turn “OFF” and all sounds and features of the SK PRO will be controlled by the front panel controls as well as by the settings from the Menus.

INITIALIZE “MANUAL”

Some Menu parameters may not be set the way you wish even if [MANUAL] is selected. If you encounter this, you can initialize all the MANUAL parameters using the following procedure.

① LOCATE THE PLAY MODE

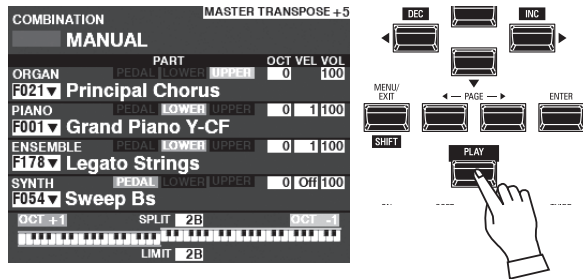

If the PLAY Mode is not displaying, press the [PLAY] button to display it.

② SELECT MANUAL

Press the [MANUAL] button “ON” (LED lit).

③ OPEN THE APP MENU

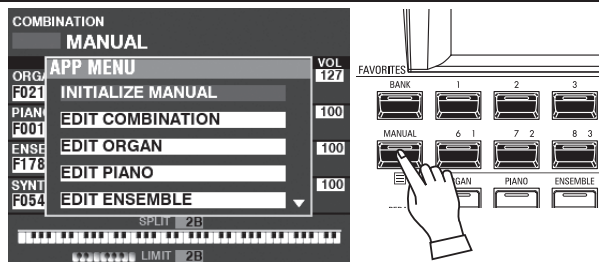

Press and hold the [≡] button to open the APP Menu.

④ SELECT “INITIALIZE MANUAL”

If “INITIALIZE [MANUAL]” is not already highlighted, use the [▲][▼] buttons to select it, and press the [ENTER] button. The screen shown below will display.

⑤ CHOOSE THE SECTION TO INITIALIZE

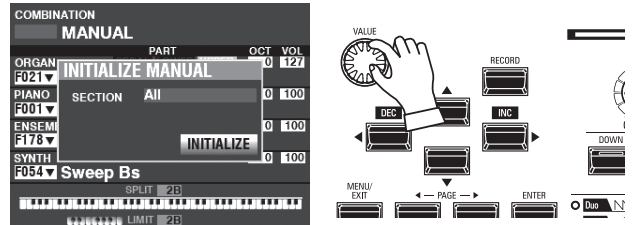

Use the [VALUE] knob to select which Section to Initialize - ALL, ORGAN or SYNTH.

⑥ COMPLETE THE PROCEDURE

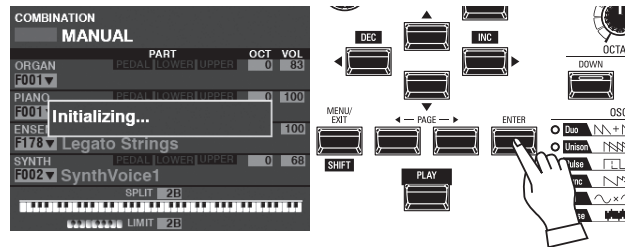

Use the [▼] button to move the cursor to the [INITIALIZE] icon, and press the [ENTER] button. The screen will display “Initializing...” for approximately 1 second.

NOTE: If you **DO NOT** wish to initialize, press the [MENU/EXIT] button.

tips “MANUAL”

The “Manual” feature cancels all Combinations, Patches, internal parameters, etc. It works much the same way as the “Adjust Presets” on Hammond Organs with Preset Keys or the “Cancel” piston on many classic organs or on electronic home organs such as the Hammond XT/XH-series. The Hammond 935 Church Organ has a feature called “Panel Memory” which performs much the same function.

ORGAN Patches are explained in detail starting below.

ALLOCATING THE SECTION TO THE KEYBOARD

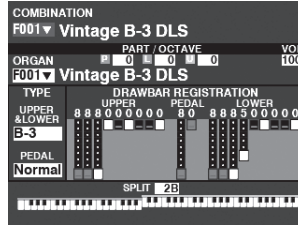
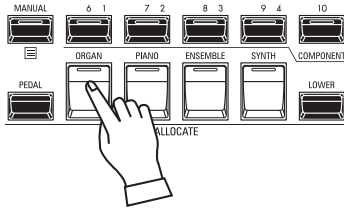

PLAY Mode (Organ)

To play an ORGAN Patch on the keyboard, simply press the [ORGAN] button in the [ALLOCATE] button group. The LED will light red.

NOTE: If only the ORGAN Section is active (no other [ALLOCATE] buttons lit), the PLAY Mode will display only the ORGAN parameters.

NOTE: The ORGAN Section has a special mode called "3 PART ORGAN" which allows the SK PRO to replicate the performance of a vintage Hammond Organ with 2 manuals and Pedals.

RECALLING A PATCH

For this example, recall "F011 Classic Gospel."

① MOVE THE CURSOR TO THE PATCH NUMBER

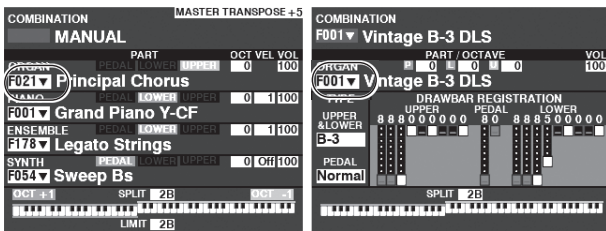

PLAY Mode (General)

PLAY Mode (Organ)

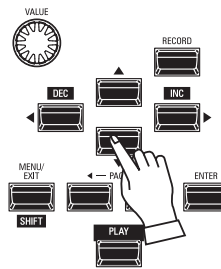

Use the [DIRECTION] buttons to move the cursor to the Patch Number in the ORGAN Section.

② OPEN THE PATCH LIST

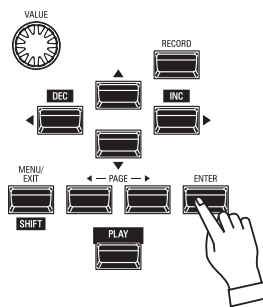
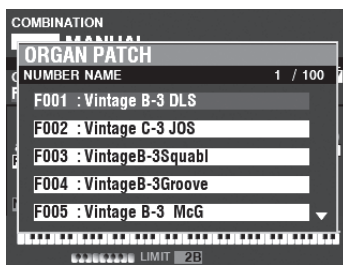

You can use the Patch List to display available Patches quickly. To open the Patch List, press the [ENTER] button when the Patch Number is highlighted in the display.

③ SELECT THE PATCH

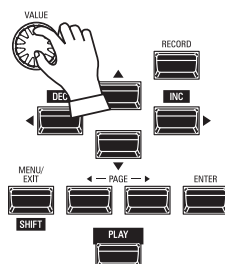
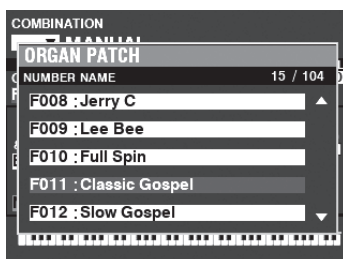

Use the [VALUE] knob to select the desired Patch. For this example, select "F011 Classic Gospel."

Press the [PLAY] or [ENTER] button to return from Patch List to PLAY Mode.

ADJUSTING THE VOLUME

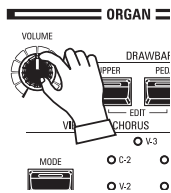
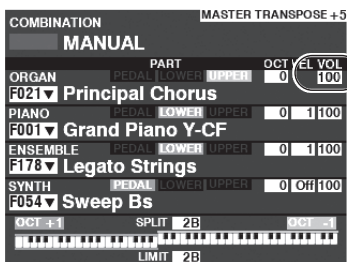

Use the [VOLUME] knob in the ORGAN Section to adjust the volume.

NOTE: You can also adjust the volume of the ORGAN Section in the PLAY screen by moving the cursor to “VOL” (right side of screen) and turning the [VALUE] knob.

CHANGING THE OCTAVE

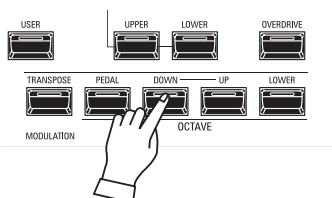

To change the Octave of the entire Keyboard (all Sections), press the OCTAVE [UP] or [DOWN] button. The display will show the current Octave setting.

NOTE: You can select “-2” (up to two octaves down) through +2” (up to two octaves up).

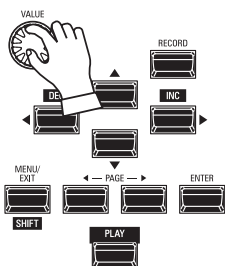
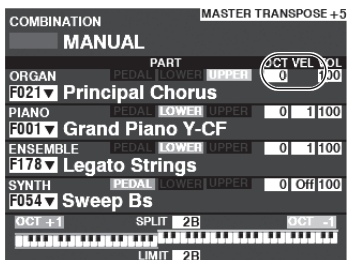

To change the Octave for the ORGAN Section only, use the [DIRECTION] buttons to move the cursor to “PLAY Mode - ORGAN Section - OCTAVE” and use the [VALUE] knob to change the Octave. The display will show the current Octave setting.

NOTE: You can select “-2” (up to two octaves down) through +2” (up to two octaves up).

The ORGAN Section can be registered for vintage Hammond Organ sounds, Combo Organs, and Pipe Organs. This is explained in more detail starting below.

SELECT [MANUAL]

Normally, one of the [FAVORITE] buttons is “ON” (LED lit), indicating that a Combination is selected. However, if you want to de-select Combinations and use the front panel controls entirely to control the sound, turn the [MANUAL] button “ON.” The [FAVORITE] buttons will all turn “OFF” and all sounds and features of the SK PRO will be controlled by the front panel controls as well as by the settings from the Menus.

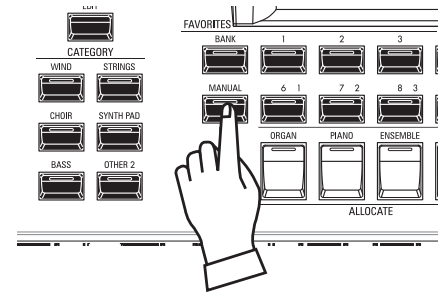

INITIALIZE “MANUAL”

Some Menu parameters may not be set the way you wish even if [MANUAL] is selected. If you encounter this, you can initialize the MANUAL parameters (P. 24).

ALLOCATE THE SECTION TO THE KEYBOARD

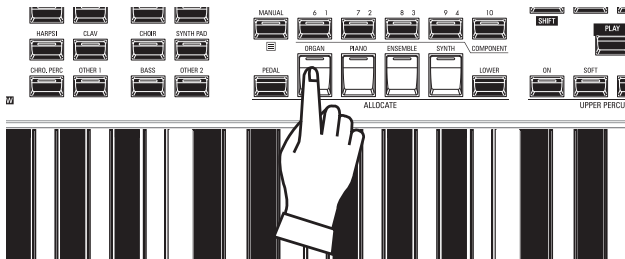

Press the [ORGAN] button in the [ALLOCATE] button group “ON.” The LED will light and the ORGAN Section will play from the keyboard.

SELECT 3 PART ORGAN

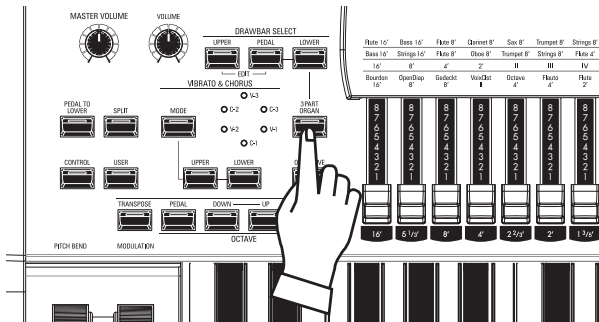

The ORGAN Section has 3 Parts - UPPER, LOWER and PEDAL. The [3 PART ORGAN] button selects how the 3 Parts are allocated. When “ON” (LED lit) the Upper, Lower and Pedal Parts are allocated automatically. When “OFF” (LED not lit) the Upper Part will play on the entire keyboard but the LOWER and PEDAL [ALLOCATE] button group buttons can still be used to allocate the entire ORGAN Section to the Lower or Pedal Parts.

SELECT THE ORGAN TYPE

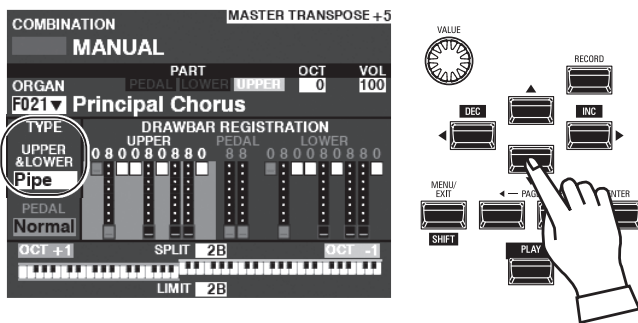

Select the ORGAN Type most appropriate to the musical style you wish to play.

Use the [DIRECTION] buttons to move the cursor to “ORGAN TYPE - UPPER&LOWER.”

Use the [VALUE] knob to select the ORGAN Type.

SELECT THE PART TO ADJUST

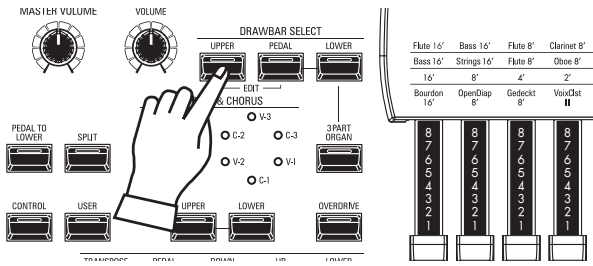

Use the [DRAWBAR SELECT] buttons to select which Part the Drawbars will adjust. For this example, press the [UPPER] button “ON” (LED lit).

ADD DRAWBARS

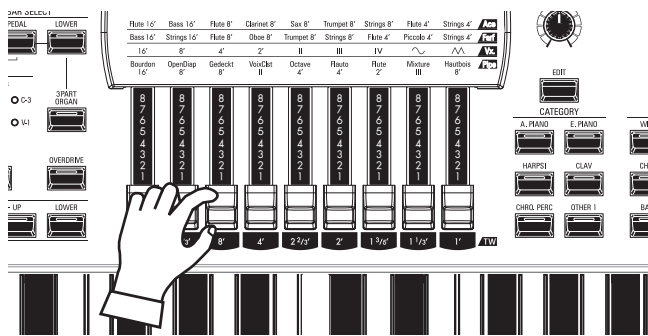

The Drawbars control the basic organ sounds. You can hear the effect each Drawbar has on the sound by pulling out or pushing in Drawbars while holding keys.

ADJUST THE VOLUME

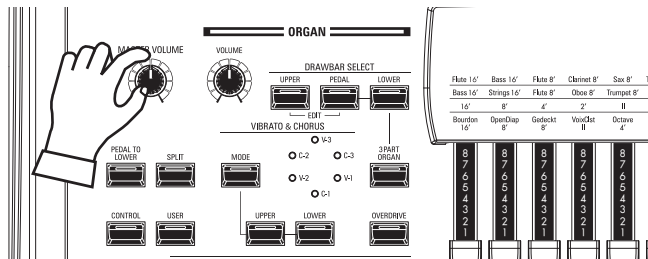

Use the [VOLUME] knob in the ORGAN Section to adjust the volume.

NOTE: You can also adjust the volume of the ORGAN Section in the PLAY screen by moving the cursor to “VOL” (right side of screen) and turning the [VALUE] knob.

CHANGING THE OCTAVE

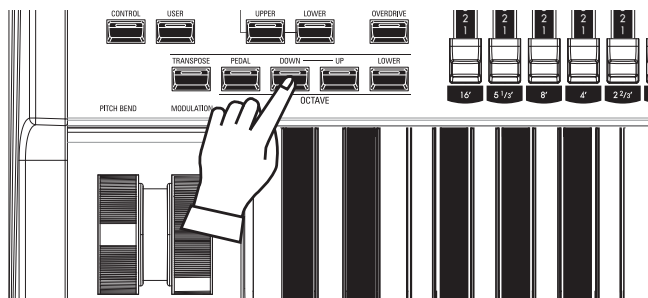

To change the Octave of the entire Keyboard (all Sections), press the OCTAVE [UP] or [DOWN] button. The display will show the current Octave setting.

To change the Octave for the ORGAN Section only, use the [DIRECTION] buttons to move the cursor to “PLAY Mode - ORGAN Section - OCTAVE” and use the [VALUE] knob to change the Octave. The display will show the current Octave setting.

NOTE: You can select “-2” (up to two octaves down) through +2” (up to two octaves up).

ADDING PERCUSSION

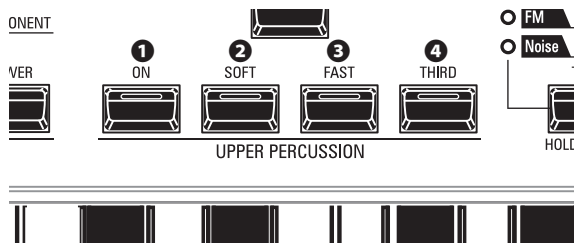

“Touch-Response Percussion” adds a percussive attack similar to a harp or bells to the Tone Wheel/Drawbar sounds. The four [PERCUSSION] buttons of the SK PRO (shown at left) control all the same functions as the tilt tablets on a tone-wheel Hammond.

- 1 **[ON] button**
Turns the Percussion effect “ON” or “OFF.”
 - 2 **[SOFT] button**
Regulates the volume of the Percussion tone. “ON” = Soft, “OFF” = Normal.
 - 3 **[FAST] button**
Controls the rate of decay of the Percussion tone. “ON” = Fast, “OFF” = Slow.
 - 4 **[THIRD] button**
Determines the pitch at which the Percussion tone sounds. “ON” = Third harmonic, “OFF” = Second harmonic
- NOTE: The Percussion features works with the “A-100,” “B-3,” “C-3” and “Mellow” Organ types only, and on the UPPER Part only.**
- NOTE: You can adjust the parameters of the Percussion to your liking. This is explained more fully in the Owner’s Manual.**

ADDING EFFECTS TO THE ORGAN SECTION

VIBRATO & CHORUS

“Vibrato & Chorus” allows you to add “Vibrato” (a periodic raising and lowering of pitch) or “Chorus” (a “shimmering” effect having the periodicity of Vibrato) to your Drawbar registrations.

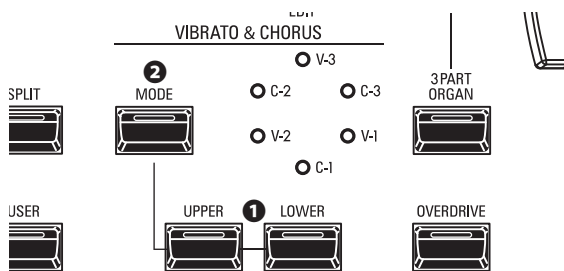

- 1 **[UPPER], [LOWER] buttons**
These allow you to turn Vibrato & Chorus “ON” or “OFF” for each Part. When “ON” the red LED will light.
 - 2 **[MODE] button**
This allows you to select from three degrees of Vibrato and three degrees of Chorus. Each successive press of this button selects a different amount of Vibrato or Chorus.
- NOTE: When the ORGAN Mode is set to “Pipe,” the Vibrato & Chorus works as a pipe organ Tremulant. You can select from six degrees of Tremulant. This is explained more fully in the Owner’s Manual.**
- NOTE: You can adjust the Vibrato & Chorus effect to your liking. This is explained more fully in the Owner’s Manual.**

LESLIE

The SK PRO has a built-in digital Leslie effect that replicates the sound of a twin-rotor Leslie Speaker cabinet. In addition, the instrument can also be used with a variety of different Leslie Speaker cabinets.

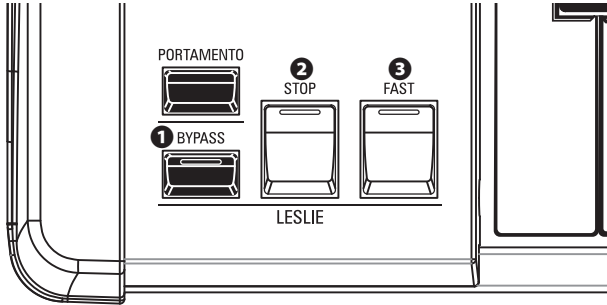

1 [BYPASS] button

Disables the Leslie effect, producing a “dry” organ sound.

2 [STOP] button

To toggle between “FAST” and “SLOW” when the [FAST] button is pressed, turn this button “OFF” (LED not lit).

To toggle between “FAST” and “STOP” when the [FAST] button is pressed, turn this button “ON” (LED lit).

3 [FAST] button

Toggles between “FAST” (LED lit) and “SLOW” (LED not lit).

NOTE: The Leslie effect is not available for the “Pipe” ORGAN Type.

NOTE: These controls perform the same functions when a Leslie Speaker cabinet is connected via the 11-pin socket.

NOTE: You can fine-tune the parameters of the inbuilt Digital Leslie. This is explained more fully in the Owner’s Manual.

OTHER EFFECTS

- OVERDRIVE

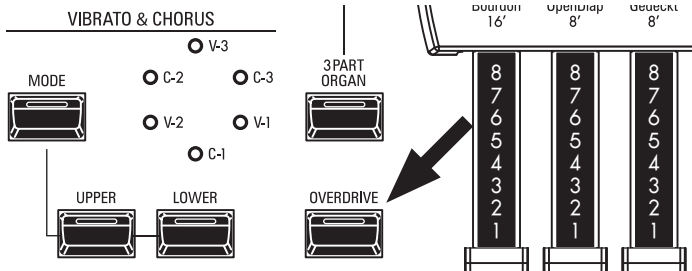

“Overdrive” adds distortion to the sound by increasing the pre-amplifier input gain. Press the OVERDRIVE button to turn the Overdrive effect “ON” (LED lit) or “OFF” (LED not lit).

- MULTI-EFFECTS

There are several “Multi Effects” which you can use to enhance the sound.

- REVERB

The SK PRO has built-in Reverb (reverberation) which allows you to simulate several different acoustic profiles.

tips EACH BUTTONS AND MODES

| BUTTON | | | MODE | |
|--------|------|------|------|-------------------------------|
| BYPASS | STOP | FAST | CH=1 | CH=3 or Digital Leslie effect |
| Off | Off | On | | Fast |
| Off | Off | Off | | Slow |
| Off | On | On | | Fast |
| Off | On | Off | | Stop |
| On | On | On | Fast | Bypass |
| On | On | Off | Stop | |
| On | Off | On | Fast | |
| On | Off | Off | Slow | |

tips WHAT IS THE LESLIE EFFECT?

When the Hammond Organ was first introduced in the mid 30’s, the sound-producing apparatus was not contained within the console. A separate “tone cabinet” had to be connected to the organ console via a special cable. For many years, Hammond manufactured tone cabinets specifically for use with Hammond Organs. The best known of these is probably the PR-40 model.

In the late 30’s, an independent engineer and organ enthusiast named Donald J. Leslie found that rotating a baffle in front of a stationary speaker created the effect of a tremulant (the well-known “Doppler effect) and called the subsequent speaker the “Vibratone.” (The “Vibratone” designation was eventually dropped and subsequent models would be known simply as Leslie Speakers.) Many models of Leslie Speakers have been made over the years; probably the best known being the models 122, 142, 145 and 147. The figure below shows the configuration of a typical twin-rotor Leslie Speaker cabinet.

The built-in digital Leslie effect on the SK PRO reproduces all three modes - Fast, Slow and Off. In addition, all three modes are available when the SK PRO is connected to an 11-pin Leslie Speaker cabinet.

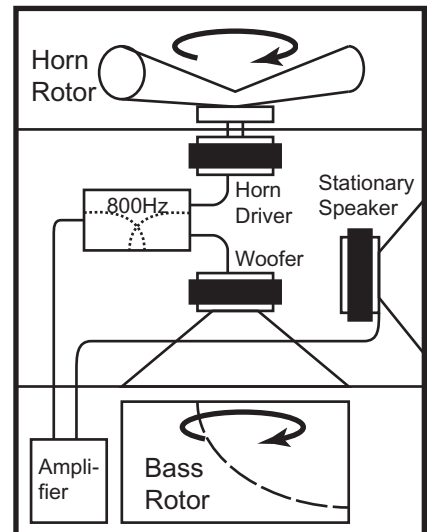

KEYBOARDS AND PARTS

The classic Hammond Organ has two manuals or keyboards and a pedal keyboard (or pedal clavier). Commonly, the two keyboards will be registered differently - for example, the Upper Keyboard will have a registration appropriate for Melody while the Lower Keyboard will have an Accompaniment registration to provide harmonic backing for the Melody. In addition, the Pedals will have a setting appropriate for bass notes.

The ORGAN Section of the SK PRO can function as a classic Hammond Organ by dividing or “Splitting” the keyboard into two Parts. When SPLIT is active, “UPPER” is the portion of the keyboard to the right of the Split point and “LOWER” is to the left of the Split point.

In addition, the Pedal Part can be played either from a connected MIDI pedalboard, or from the keyboard by using the PEDAL TO LOWER feature when SPLIT is active.

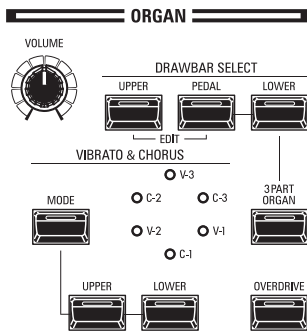
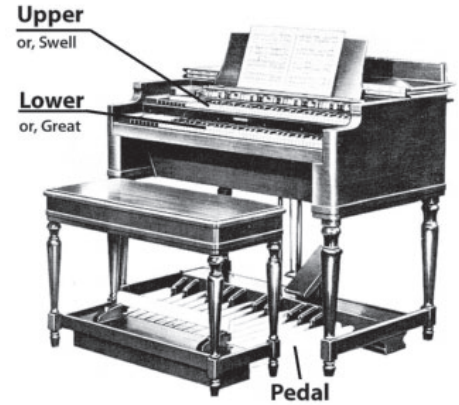

1 [3PART ORGAN] button

Allows you to select whether the ORGAN Section will function as a classic Hammond Organ with two manuals and pedals or as a single-manual organ.

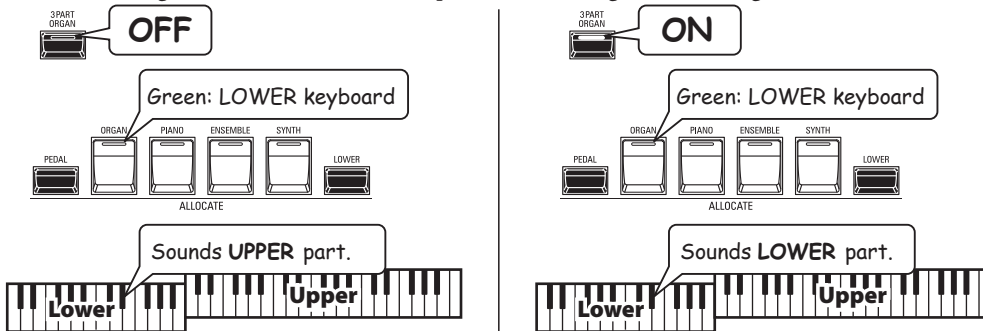

ONThe ORGAN Section will function as a classic two-manuals-and-pedals Hammond Organ.

OFFThe ORGAN Section can either sound on the entire keyboard, or be dynamically assigned to UPPER, LOWER or PEDAL.

2 [DRAWBAR SELECT] buttons

Allow you to use the Drawbars to control the sounds for each ORGAN Part. If the LED of one of these buttons is lit, the Drawbars will control the sounds represented by that button.

ORGAN TYPES

The Drawbars on your SK PRO can be made to control organ sounds other than traditional Hammond Drawbars. Several makes of combo organs, for example, also used Drawbar-type controls to register the sounds, which were actual organ voices rather than individual harmonics as with Hammond Drawbars.

TONE WHEEL (A-100, B-3, C-3)

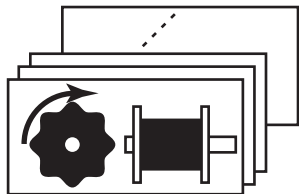

The Hammond Organ's original purpose was to duplicate the pipe organ, however, they became famous for producing a unique sound of their own.

Tone Wheels are the method by which tone-wheel Hammond Organs generate sound. Each frequency is generated by a steel disk 1 7/8" in diameter and containing a number of high spots on its outer edge. (See the illustration above.) These disks are the Tone Wheels. The most common tone-wheel generator has a total of 96 tone wheels, all with different numbers of teeth - some wheels have 2 teeth, others have 4, 8, 16, 32, 64, 128, up to 192 teeth. The classic Tone Wheel design uses 91 tone wheels to generate the musical tones.

A-100, **B-3** and **C-3** are traditional Tone Wheel sounds.

MELLOW

The **Mellow** setting replicates the non-mechanical electronic Hammond tone generators such as the Concorde, the X-5 combo organ and the later "multiplex" organs such as the B-3000 and 340 series Elegante.

TRANSISTOR (Vx, Farf, Ace)

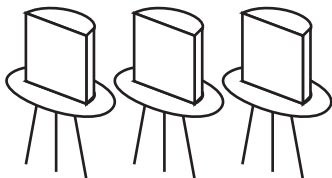

As transistors gradually replaced vacuum tubes in electronic circuits it became possible to produce light-weight combo organs. These have been used extensively in rock and popular music since the early 60's. The type of circuitry is different from maker to maker or model by model. We have replicated 3 representative types here.

Vx replicates a British combo organ which combines triangle waves and square waves using several footages. "Farf" and "Ace" both replicate combo organs (Italian and Japanese) which use tablets to combine sound waves which are filtered to produce different tones.

PIPE

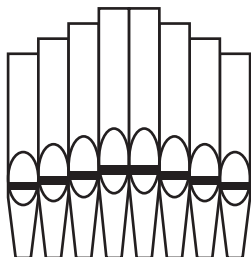

A pipe organ produces sounds by pushing pressurized air through sets of wood or metal pipe called Ranks or Stops. There are many different types of Pipe Stops which produce sounds of different pitches, timbres and levels of volume. Each Stop is identified by a unique name indicating what type of sound it will produce when selected.

The **Pipe** ORGAN Type replicates several different types of pipe organs by using the Drawbars as drawstops or stop tablets to create pipe organ registrations.

tips PEDAL ORGAN TYPES

When using the "B-3," "C-3," "A-100" or "Mellow" ORGAN Types for the UPPER & LOWER Parts, you can select two different PEDAL Voicings - "Normal" and "Muted." "Normal" replicates the Pedal Drawbars of a vintage Hammond Organ while "Muted" more nearly duplicates the mellow Pedal Drawbar tones of an electronic Hammond.

On "Vx," "Farf," and "Ace" ORGAN Types, the PEDAL Voicing is automatically set to "Muted." For "Pipe," the Pedal Drawbars register Pipe organ voices to complement the UPPER and LOWER Pipe Voices.

The Harmonic Drawbars are the heart of the renowned Hammond Sound and have been used since the first Hammond Organ Model A was introduced in 1935. There are approximately 253,000,000 possible sound combinations that can be produced by these Drawbars. The illustration below shows how each Drawbar relates to the manual when middle “C” is pressed.

NOTE: When recalling Combinations or ORGAN Patches, the positions of the Drawbars will change internally, but not physically. When a Drawbar is moved, the Patch setting will update to that Drawbar’s current position. You can also match the entire Drawbar registration to the physical Drawbar setting. (P.40).

DRAWBARS (A-100, B-3, C-3, Mellow)

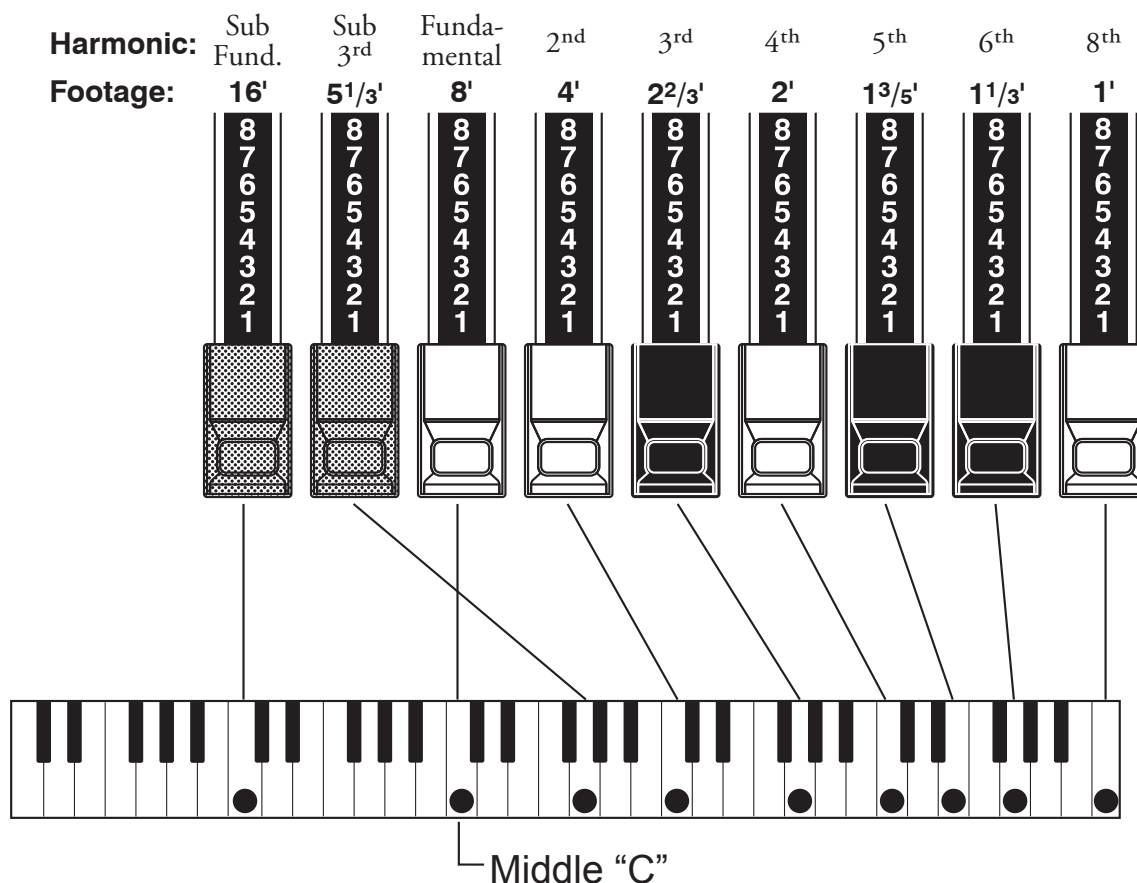

Each Drawbar may be set in eight different positions in addition to the silent or “0” position. Each position, as marked on the Drawbars, represents a different degree of intensity of the harmonic it controls. When drawn out to position “1,” the harmonic it represents will be present with minimum intensity, when drawn out to position 2 with greater intensity, and so on up to position “8.”

If you pull the fundamental (8’) the third harmonic (2 2/3’) plus the fifth harmonic (1 3/5’) Drawbars out completely and play the keyboard you will notice the sound resembles a clarinet.

If you push the 8’ Drawbar half-way, you’ll notice the sound becomes more high-pitched and a bit “harder.” Now pull the 8’ Drawbar back out fully and push the 2 2/3’ and 1 3/5’ in halfway. Notice how the sound becomes mellower.

Experiment with the Drawbars to obtain your own favorite registrations.

tips DRAWBAR REGISTRATION

Below is an example of using Drawbars to create different sounds.

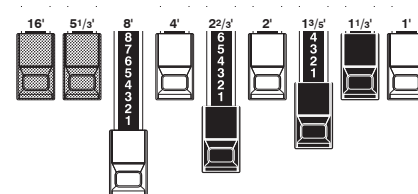

Example of “Clarinet”



For “Tone Wheel” ORGAN Types, the relationship between each Drawbar and its footage is shown on the “TW” legends directly in front of the Drawbars.

DRAWBARS FOR THE UPPER AND LOWER PARTS

The Colors of the Drawbars are traditional to Hammond, and were established to provide a quick visual guide to the harmonics generated by the Drawbars.

WHITE DRAWBARS

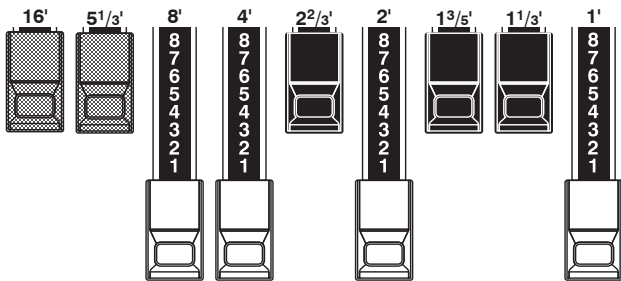

The first white Drawbar represents the “fundamental” or “8’ base” tone. All of the other white Drawbars are octave intervals or harmonics of the fundamental tone. The tonal brilliance is greatly increased by adding white Drawbars, but the harmonics added are always in “consonance” or harmony.

BLACK DRAWBARS

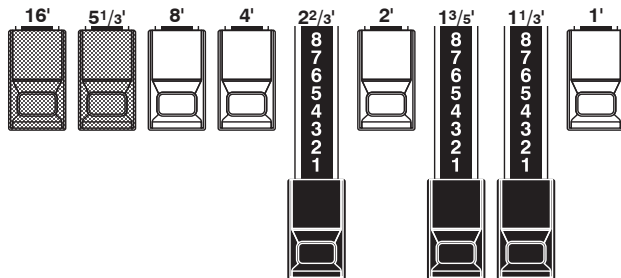

The black Drawbars represent the “dissonant” harmonics which are also necessary in building rich tone colors. The mellowness of a horn, the pungency of strings, and the brilliance of reed voices owe much of their character to the presence of these harmonics in different degrees.

BROWN DRAWBARS

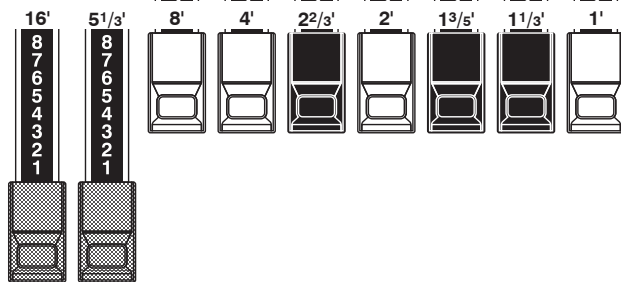

The two brown Drawbars on the far left give depth and richness to the sound. The left 16’ is one octave lower than the 8’, and 5 1/3’ is the third harmonic of the 16’ fundamental. Normally, the tones are built on the 8’ fundamental, but, if you want to add depth to the tone or to expand the playing range by one octave lower, build your tones on the 16’ fundamental.

PEDAL DRAWBARS

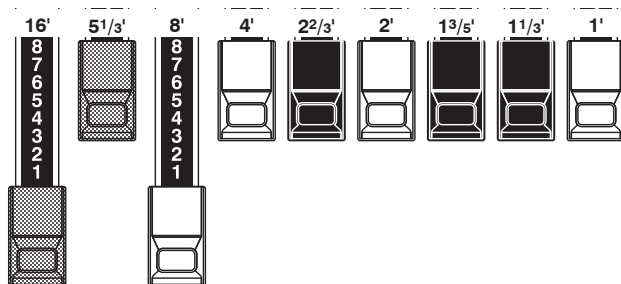

The 16’ and 8’ Drawbars control the sounds produced by the Pedal part. The first brown Drawbar produces a composite tone at 16’ pitch for a deep foundation bass, while the first white Drawbar produces a composite tone at 8’ pitch, or one octave higher.

DRAWBAR REGISTRATION PATTERNS

Regardless of the size of a pipe organ or its number of stops, all of its voices are related to four basic families of tone. The four basic families - Flute, Reed, String and Diapason - can be quickly set up on the Drawbars by relating a pattern or shape to each family.

FLUTE FAMILY (2 STEP PATTERN)

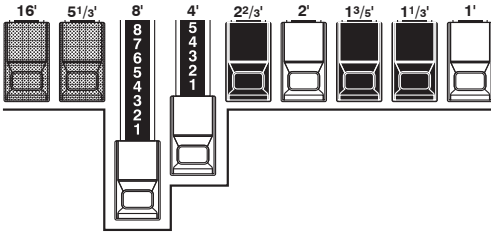

| | |
|---------------------------------|-------------|
| Accompaniment Flute 8' I..... | 00 8460 000 |
| Accompaniment Flute 8' II..... | 00 3220 000 |
| Accompaniment Flute 8' III..... | 00 8600 000 |
| Chorus of Flutes 16'..... | 80 8605 002 |
| Orchestral Flute 8'..... | 00 3831 000 |
| Piccolo 2'..... | 00 0006 003 |
| Stopped Flute 8'..... | 00 5020 000 |
| Tibia 8'..... | 00 7030 000 |
| Tibia 4'..... | 00 0700 030 |
| Tibia (Theater) 16'..... | 80 8605 004 |
| Wooden Open Flute 8'..... | 00 8840 000 |

DIAPASON FAMILY (CHECK MARK PAT- TERN)

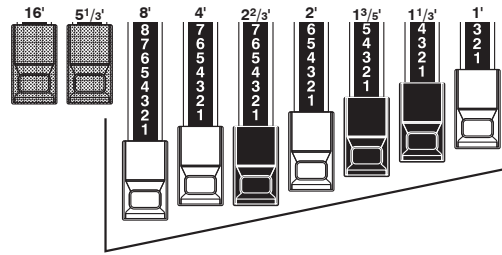

| | |
|----------------------------|-------------|
| Accomp. Diapason 8'..... | 00 8874 210 |
| Chorus Diapason 8'..... | 00 8686 310 |
| Diapason 8'..... | 00 7785 321 |
| Echo Diapason 8'..... | 00 4434 210 |
| Harmonic Diapason 16'..... | 85 8524 100 |
| Harmonic Diapason 8'..... | 00 8877 760 |
| Harmonic Diapason 4'..... | 00 0606 045 |
| Horn Diapason 8'..... | 00 8887 480 |
| Open Diapason 8'..... | 01 8866 430 |
| Solo Diapason..... | 01 8855 331 |
| Wood Diapason 8'..... | 00 7754 321 |

REED FAMILY (TRIANGLE PATTERN)

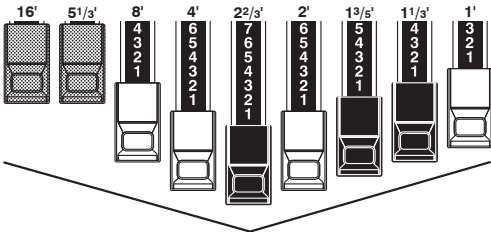

| | |
|----------------------|-------------|
| Bassoon 16'..... | 44 7000 000 |
| Clarinet 8'..... | 00 6070 540 |
| English Horn 8'..... | 00 3682 210 |
| Flugel Horn 8'..... | 00 5777 530 |
| French Horn..... | 00 7654 321 |
| Kinura 8'..... | 00 0172 786 |
| Oboe 8'..... | 00 4764 210 |
| Trombone 8'..... | 01 8777 530 |
| Trumpet 8'..... | 00 6788 650 |
| Tuba Sonora 8'..... | 02 7788 640 |
| Vox Humana 8'..... | 00 4720 123 |

STRING FAMILY (BOW PATTERN)

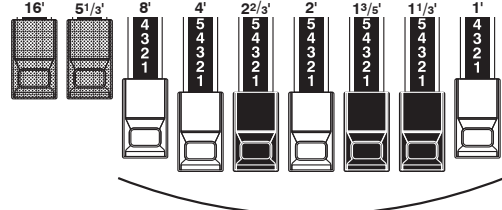

| | |
|---------------------------|-------------|
| Cello 8'..... | 00 3564 534 |
| Dulciana 8'..... | 00 7770 000 |
| Gamba 8' I..... | 00 3484 443 |
| Gemshorn 8'..... | 00 4741 321 |
| Orchestral String 8'..... | 00 1464 321 |
| Salicional 8'..... | 00 2453 321 |
| Solo Viola 8'..... | 00 2474 341 |
| Solo Violin 8'..... | 00 3654 324 |
| Viola da Gamba 8'..... | 00 2465 432 |
| Violina 4'..... | 00 0103 064 |
| Violone 16'..... | 26 3431 000 |

Notice that Drawbar registrations are expressed in number groups of 2, 4 and 3. This “2-4-3” number formula for Drawbar Registration has been a Hammond convention since the beginning. It has been found to be the easiest way to convey a specific setting. The first two numbers correspond to the two brown Drawbars of either manual. The middle four numbers designate the 8', 4', 2 2/3', 2' Drawbars, and the remaining three numbers refer to the last three Drawbars.

MODERN DRAWBAR REGISTRATIONS

The Drawbar registration patterns shown on the previous page are intended to simulate the four basic families of tone found on a classical pipe organ, since this was the original intention of the Hammond Organ. Later on, as the Hammond Organ began to be used in Jazz, Pop and Rock music, other sounds became identified with the “Hammond Sound.” The figures below illustrate some of these modern registrations.

JAZZ

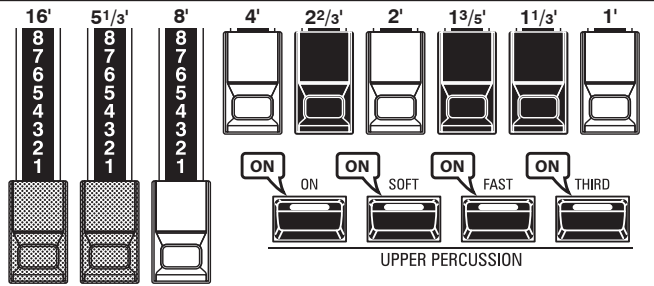

BLUESY

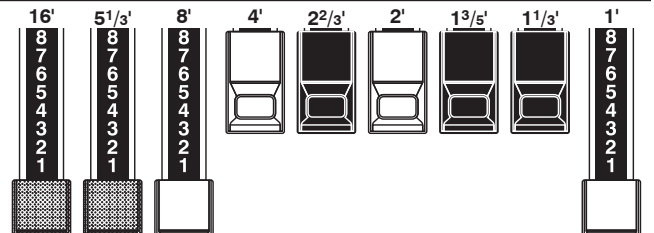

GROOVY & FUNKY

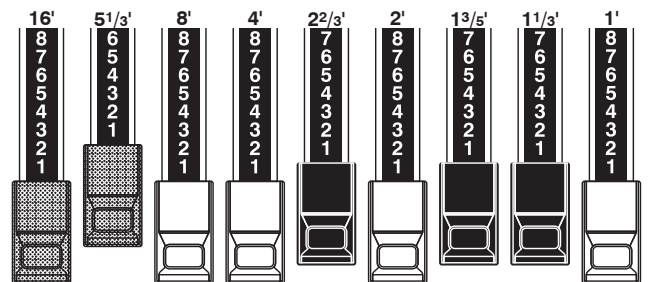
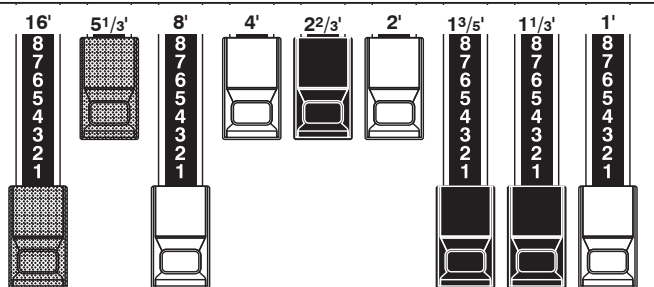

SQUABBLE (“Erroll Garner” Registration)

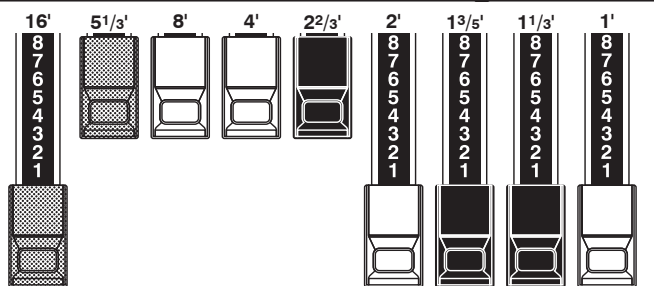

tips APPLICATION OF PERCUSSION

When Percussion is used, the sound of the 1' Drawbar is cancelled just as it is on vintage organs (B-3, C-3, A-100, M-3, etc.). Some jazz organists have taken advantage of this idiosyncrasy by keeping the 1' Drawbar pulled out and turning Percussion “ON” and “OFF” while playing. The result is an instantaneous registration change with a single motion.

DRAWBARS (Vx)

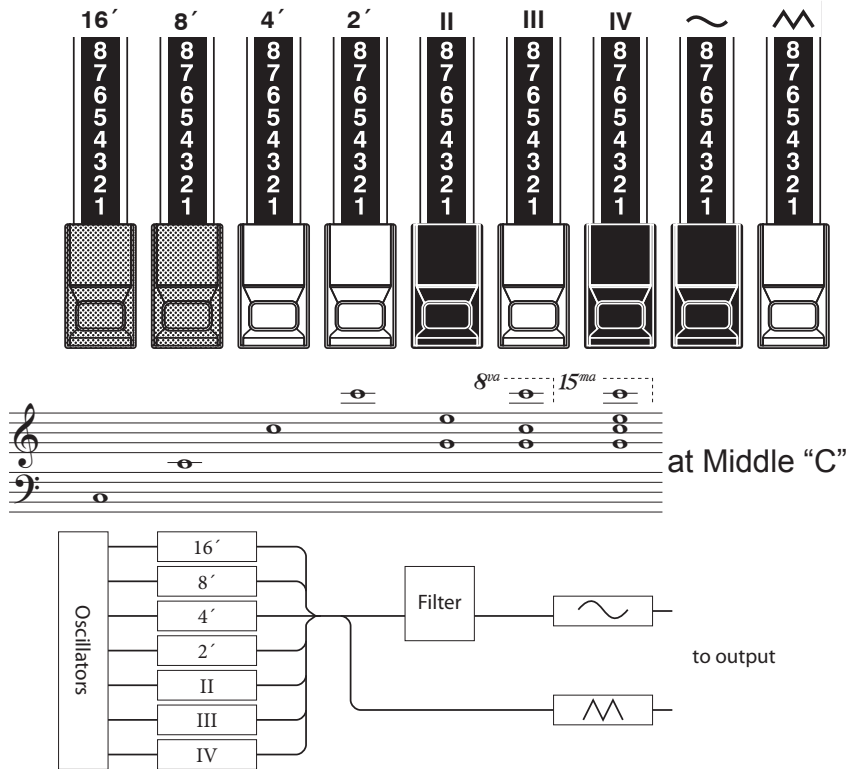

The type of British combo organ replicated by the “Vx” ORGAN Type had Drawbar-type controls, but they functioned differently from Hammond Harmonic Drawbars. The first four Drawbars control individual pitches, while the next three are “Mixture” Drawbars which cause multiple pitches to sound. “II,” “III” and “IV” refer to the number of pitches represented by that Drawbar.

The last two Drawbars control the type of tone produced by the first seven Drawbars.

The “~” Drawbar causes mellow tones to sound while the “^” Drawbar causes brighter and more harmonically complex tones to sound.

NOTE: The first seven Drawbars WILL NOT sound unless one or both of the right two Drawbars are also “out.” These two Drawbars regulate the overall volume as well as timbre of the total Drawbar registration, and can be used separately or together.

tips FOOTAGE

“Footage” is a term inherited from the pipe organ. It is used to designate the pitch at which a particular organ stop will sound. The number refers to the length of pipe necessary to produce the lowest note of that particular stop. For example, if a stop is marked “8” it means that the lowest note on a standard 5-octave organ keyboard “C” will require a pipe 8 feet long.

| | | | | | | | | | |
|-------------|-------------|------------|-------------|------------|------------|------------|-------------|-------------|-------------|
| Flute 16' | Bass 16' | Flute 8' | Clarinet 8' | Sax 8' | Trumpet 8' | Strings 8' | Flute 4' | Strings 4' | Acc |
| Bass 16' | Strings 16' | Flute 8' | Oboe 8' | Trumpet 8' | Strings 8' | Flute 4' | Piccolo 4' | Strings 4' | Farf |
| 16' | 8' | 4' | 2' | II | III | IV | ~ | ^ | Vx. |
| Bourdon 16' | OpenDiap 8' | Gedeckt 8' | VoixClt 8' | Octave 4' | Flauto 4' | Flute 2' | Mixture III | Hautbois 8' | Pipa |

When using the “Vx” ORGAN Type, refer to the “Vx” row above the Drawbars for the correspondence between each Drawbar and the voice, footage and timbre.

DRAWBARS (Farf, Ace)

Farf

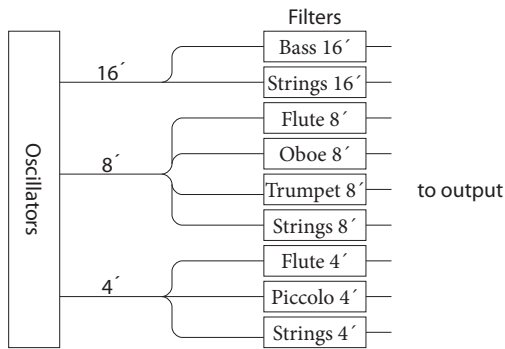
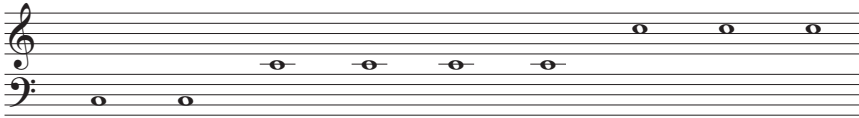
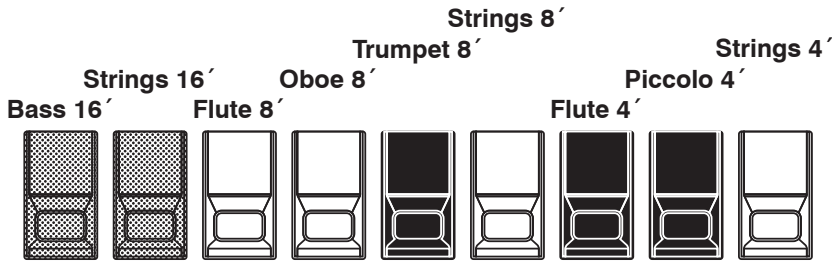

at Middle "C"

tips TABLET

The word "tablet" refers to a tilting or "rocker"-type control used on many analog organs to turn voices "ON" and "OFF" as well as to add effects (see figure below).



Ace

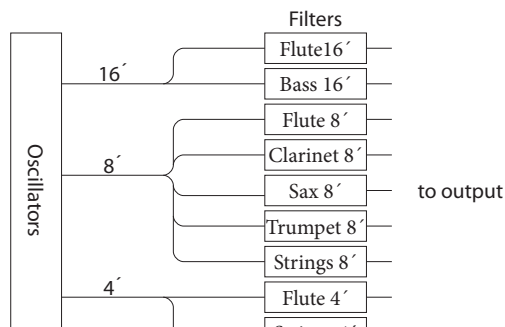
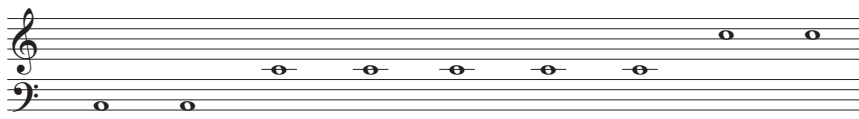
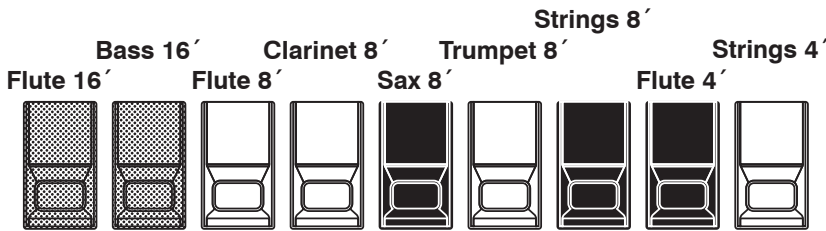

at Middle "C"

| | | | | | | | | | |
|-------------|-------------|------------|-------------|------------|------------|------------|-------------|-------------|-------------|
| Flute 16' | Bass 16' | Flute 8' | Clarinet 8' | Sax 8' | Trumpet 8' | Strings 8' | Flute 4' | Strings 4' | Ace |
| Bass 16' | Strings 16' | Flute 8' | Oboe 8' | Trumpet 8' | Strings 8' | Flute 4' | Piccolo 4' | Strings 4' | Farf |
| 16' | 8' | 4' | 2' | II | III | IV | ~ | ^ | Vx. |
| Bourdon 16' | OpenDiap 8' | Gedeckt 8' | VoixCst II | Octave 4' | Flauto 4' | Flute 2' | Mixture III | Hautbois 8' | Pipe |

When using the "Farf" or "Ace" ORGAN Types, refer to the "Farf" or "Ace" row above the Drawbars for the correspondence between each Drawbar and the voice and footage.

DRAWBARS (Pipe)

F1: Classic

UPPER: Bourdon 16' Open Diapason 8' Gedeckt 8' Viole Celeste II Octave 4' Flauto Dolce 4' Flute 2' Mixture III Hautbois 8'

LOWER: Principal 16' Principal 8' Melodia 8' Rohr Flute 8' Prestant 4' Flute 4' Super Octave 2' Mixture IV Trompette 8'

PEDAL: Sub Bass 16' + Gedeckt 8' Diapason 8' + Flute 4'

When using the "Pipe" ORGAN Type, the stops are registered through the Drawbars. The Classic type follows the classic organ layout left to right as follows: Flue, Mixture and Reed.

On the UPPER and LOWER Parts, each Drawbar corresponds with a pipe organ rank or stop.

On the PEDAL part, two stops sound with one Drawbar (Complex Stop).

NOTE: When "Classic" is activated, the Drawbars will function similar to drawstops on a traditional pipe organ - pulling a Drawbar "out" will turn the associated Pipe Voice "ON" while pushing the Drawbar "in" will turn the Pipe Voice "OFF." The Pipe Voices do not have gradations of volume - they are either "ON" or "OFF."

NOTE: The labels "F1", "F2" etc., refer to Custom Pipes.

NOTE: The Leslie effect is not available on the Pipe Voices. However, the Vibrato/Chorus feature becomes a pipe organ Tremulant when the "Pipe" ORGAN Type is selected.

F2: Theatre 1

UPPER: Tibia Clausa 16' Vox Humana 8' Style "D" Trumpet 8' Tibia Clausa 8' Clarinet 8' Viol d'Orch 8' Vox Humana 8' Tibia Clausa 4' Tibia Clausa 2'

LOWER: Style "D" Trumpet 8' Open Diapason 8' Clarinet 8' Viol d'Orch 8' Flute 8' Vox Humana 8' Open Diapason 4' Tibia Clausa 4' Vox Humana 4'

PEDAL: Tibia 16' + Flute 8' Diapason 8' + Flute 4'

The Theatre 1 and Theatre 2 PIPE settings provide a complement of organ stops characteristic of a theatre or "cinema" organ. "Theatre 1" is a stop complement similar to a Wurlitzer "Style 210" while "Theatre 2" is derived from the stops from a Wurlitzer "Style 260 Special," including English Post Horn. The figures on the left show the stop complements for the Theatre 1 and Theatre 2 Custom Pipe sets.

NOTE: When "Theatre 1" or "Theatre 2" is activated, the Drawbars will function similar to tablets on a theatre organ console.

F3: Theatre 2

UPPER: Tibia Clausa 16' English Post Horn 16' Brass Trumpet 8' Tibia Clausa 8' Clarinet 8' Vox Humana 8' Tibia Clausa 4' Tibia Clausa 2 2/3' Tibia Clausa 2'

LOWER: Brass Trumpet 8' Diapason 8' Clarinet 8' Viol Celeste 8' Oboe 8' Flute 8' Vox Humana 8' Viol Celeste 4' Flute 4'

PEDAL: Tibia 16' + Flute 8' Diapason 8' + Flute 4'

tips STOP

A single voice or sound on a pipe organ is referred to as a "Stop" due to the fact that air flow is "stopped" (or started) by manipulating the individual controls which turn sounds "ON" or "OFF."

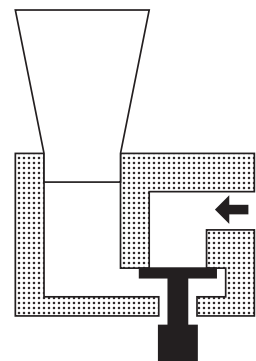

| | | | | | | | | | |
|-------------|-------------|------------|-------------|------------|------------|------------|-------------|-------------|-------------|
| Flute 16' | Bass 16' | Flute 8' | Clarinet 8' | Sax 8' | Trumpet 8' | Strings 8' | Flute 4' | Strings 4' | Ace |
| Bass 16' | Strings 16' | Flute 8' | Oboe 8' | Trumpet 8' | Strings 8' | Flute 4' | Piccolo 4' | Strings 4' | Farf |
| 16' | 8' | 4' | 2' | II | III | IV | ~ | ^ | Vx. |
| Bourdon 16' | OpenDiap 8' | Gedeckt 8' | VoixClst II | Octave 4' | Flauto 4' | Flute 2' | Mixture III | Hautbois 8' | Pipe |

If the ORGAN Type is "Pipe," refer to the "Pipe" row on the other side of the Drawbars for the correspondence between each Drawbar and the footage.

ORGAN SECTION OPERATION

MATCHING THE REGISTRATION TO DRAWBARS

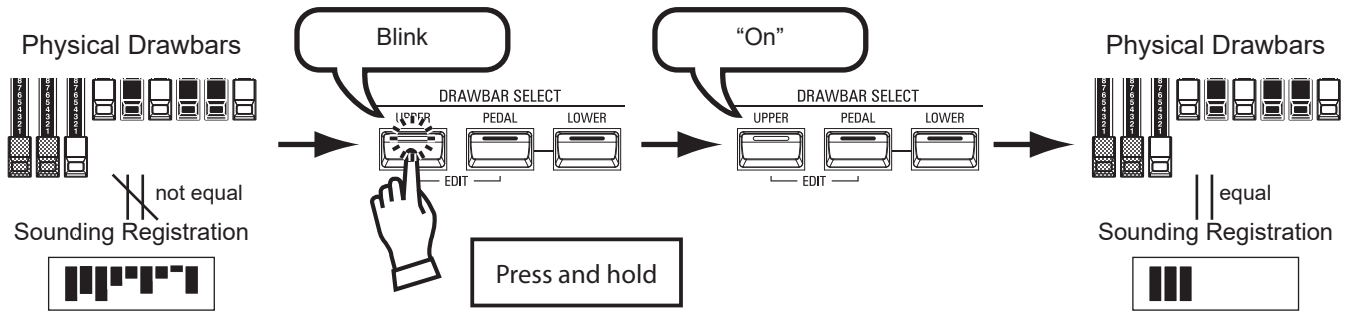

When you recall an ORGAN Patch, the Drawbar registration of the recorded Patch is heard, instead of the physical Drawbar setting. If you move any Drawbar, its position takes precedence over the recorded registration, although the Patch is not changed.

If you want to switch to the physical Drawbar setting immediately, Press and Hold any of the three DRAWBAR SELECT buttons ([UPPER] [PEDAL] or [LOWER]) until the button LED blinks then release it. The physical registration now becomes “current” for the selected Part.

SHOWING CURRENT SETTINGS

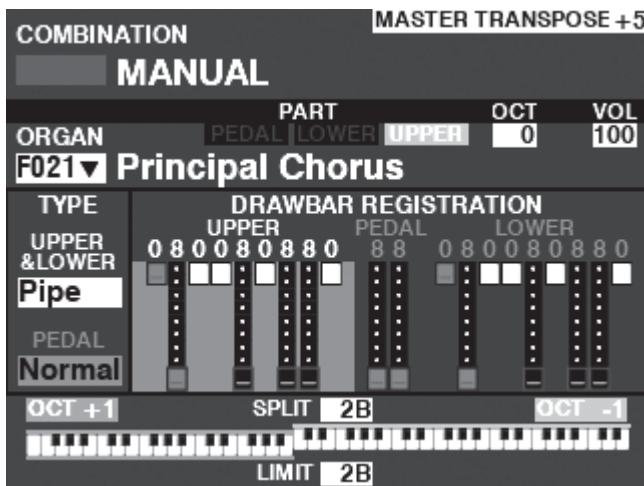

When you are in PLAY Mode, a page similar to the one shown at left will display if the ORGAN Section only is selected via the [ALLOCATE] button or by repeatedly touching the [PLAY] button.

The PIANO and ENSEMBLE Voice Sections allow you to play various instrumental and vocal sounds such as Piano, Strings, Trumpet, Choir, etc. This is explained in more detail starting below.

ALLOCATING THE SECTION TO THE KEYBOARD

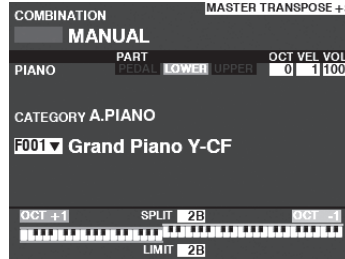
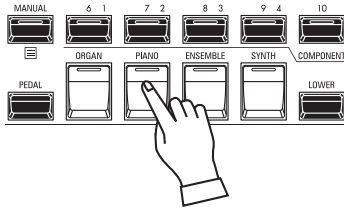

PLAY Mode (Piano)

To play a PIANO or ENSEMBLE Patch on the keyboard, simply press the [PIANO] or [ENSEMBLE] button in the [ALLOCATE] button group. The LED will light red.

NOTE: If only the PIANO or ENSEMBLE Section is active (no other [ALLOCATE] buttons lit), the PLAY Mode will display only the PIANO / ENSEMBLE parameters.

NOTE: If the SPLIT button is "ON" (LED lit), the PIANO / ENSEMBLE will play to the right of the SPLIT Point only.

RECALLING A PATCH

For this example, recall "EP Tine Mk2"

① SELECT A CATEGORY

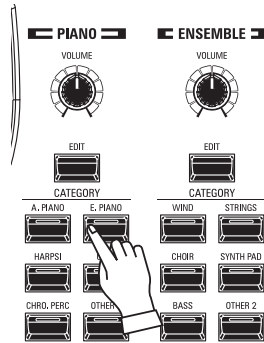
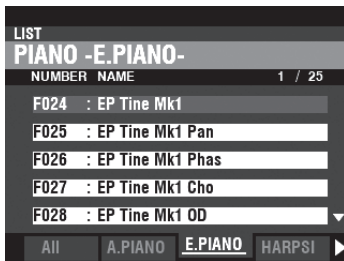

Select a Voice Category from the PIANO or ENSEMBLE Section. For this example, press the [E. PIANO] button in the PIANO Category. The display will show the Patch List for the selected category.

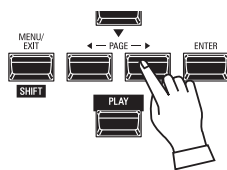
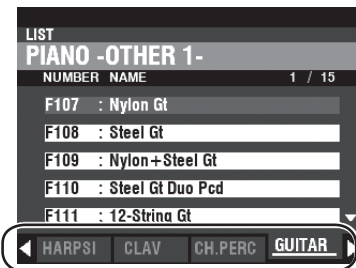

USING THE "OTHER" VOICE CATEGORY

Both the PIANO and ENSEMBLE Voice Sections have a category called [OTHER]. These include various groups of Voices not represented by buttons on the Control Panel.

To select a Voice in the [OTHER] Category:

1. Press the [OTHER] button to display the Patch List.
2. Use the [PAGE] buttons to select among the available Voice Categories.
3. Use the [▲]/[▼] buttons to select a Voice from the selected Category. Press [ENTER] to select the Voice you wish.

② SELECT THE PATCH

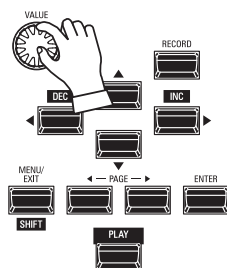

Use the [VALUE] knob to scroll through the Patch List.

NOTE: You can also use the PAGE [◀/▶] buttons to scroll through the Patch List.

ADJUSTING THE VOLUME

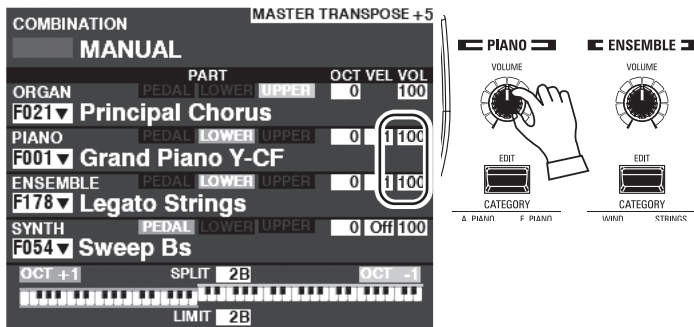

Use the [VOLUME] knob in the PIANO or ENSEMBLE Section to adjust the volume of the selected Section. For this example, use the [VOLUME] knob in the PIANO Section.

NOTE: You can also adjust the volume of the PIANO and ENSEMBLE Sections in the PLAY screen by moving the cursor to “VOL” (right side of screen) and using the [VALUE] knob.

ADJUST THE VELOCITY SENSITIVITY

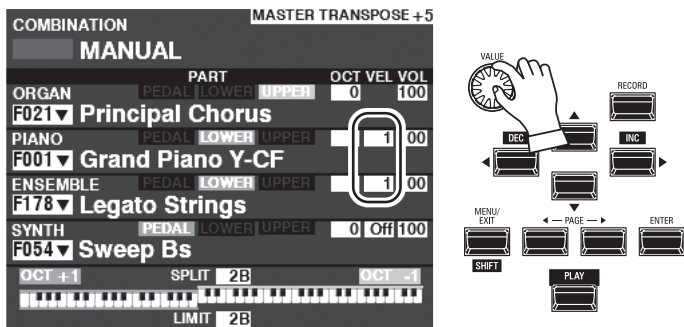

Use the [DIRECTION] buttons to move the cursor to “VEL,” and use the [VALUE] knob to select the Velocity Curve. The setting range is “OFF” and “1” to “4.”

At “OFF”, the velocity is fixed at 100. The “touch” (velocity response) of the keyboard progresses from 1 (heavier) through 4 (lighter).

NOTE:: The Velocity setting will vary from Patch to Patch.

CHANGING THE OCTAVE

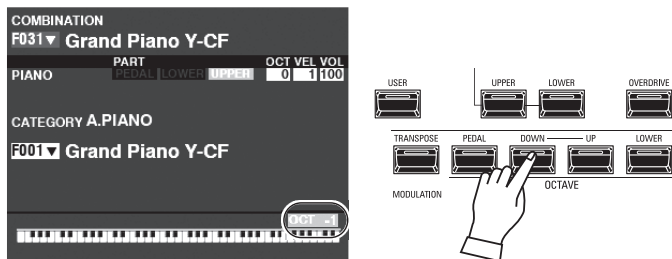

To change the Octave of the entire UPPER Keyboard (all Sections), press the OCTAVE [UP] or [DOWN] button. The display will show the current Octave setting.

NOTE: You can select “-2” (up to two octaves down) through +2” (up to two octaves up).

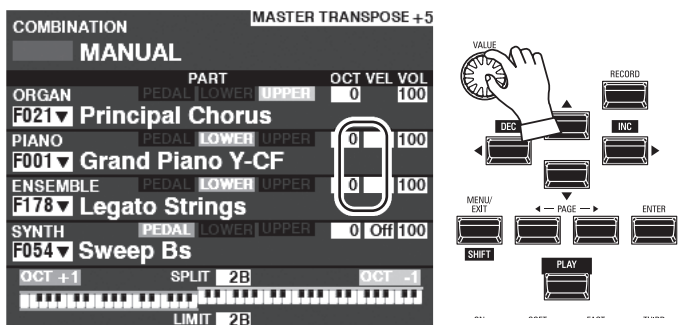

To change the Octave for the PIANO Section only, use the [DIRECTION] buttons to move the cursor to “PLAY Mode - PIANO Section - OCTAVE” and use the [VALUE] knob to change the Octave. The display will show the current Octave setting.

NOTE: You can select “-2” (up to two octaves down) through +2” (up to two octaves up).

tips DIFFERENCE BETWEEN PIANO AND ENSEMBLE

The PIANO and ENSEMBLE Sections contain the same voices; however, to make registration of certain types of sounds easier, the inbuilt voices are separated into PIANO and ENSEMBLE Sections. The PIANO Section consists of Category buttons appropriate for keyboard and other Percussion voices, while the ENSEMBLE Section consists of voices such as Strings, Choir, Wind instruments, Synth voices and other primarily instrumental and vocal sounds. However, all inbuilt voices can be played from either the PIANO or ENSEMBLE Categories - if desired, the PIANO Section can play Strings, the ENSEMBLE Category can play Electric Piano, and so on.

MONO SYNTH Patches are explained in detail starting below.

ALLOCATING THE SECTION TO THE KEYBOARD

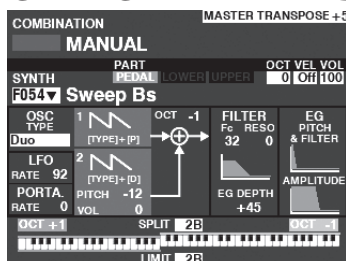
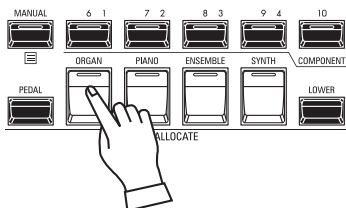

PLAY Mode (Mono Synth)

To play the MONO SYNTH on the keyboard, simply press the [MONO SYNTH] button in the [ALLOCATE] button group. The LED will light red.

NOTE: If only the MONO SYNTH Section is active (no other [ALLOCATE] buttons lit), the PLAY Mode will display only the MONO SYNTH parameters.

NOTE: If the SPLIT button is "ON" (LED lit), the MONO SYNTH will play to the right of the SPLIT Point only.

RECALLING A PATCH

For this example, recall MONO SYNTH Patch F048 ("4th Saw Ld").

1 MOVE THE CURSOR TO THE MONO SYNTH PATCH NUMBER

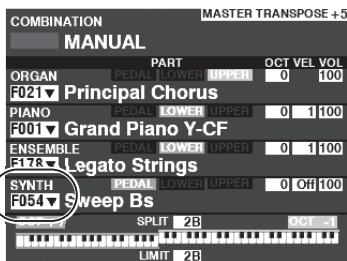

PLAY Mode (Combination)

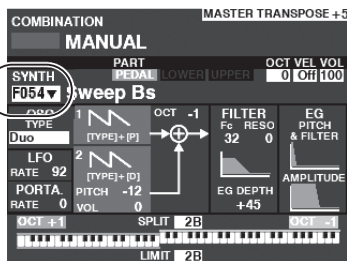

PLAY Mode (Mono Synth)

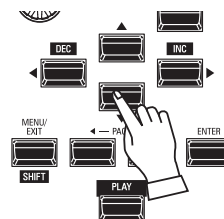

Use the [DIRECTION] buttons to move the cursor to the MONO SYNTH Patch Number.

2 OPEN THE PATCH LIST

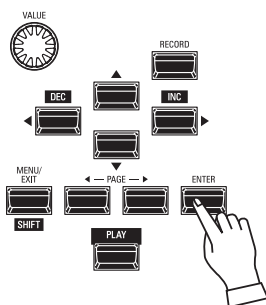
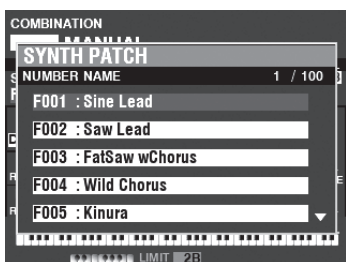

The Patch List allows you to scroll through the Patches quickly to find the Patch you want.

With the cursor highlighting the Patch Number, press [ENTER] to open the Patch List. You will see a screen similar to the one shown at the left.

3 SELECT THE PATCH

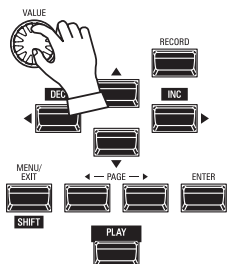
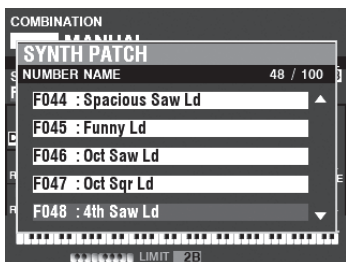

Use the [VALUE] knob to scroll through the Patch List.

For this example, when you have located Patch F048 ("4th Saw Ld"), press either the [PLAY] or [ENTER] button to return from Patch List to PLAY Mode.

NOTE: You can also use the PAGE [◀/▶] buttons to scroll through the Patch List.

ADJUSTING THE VOLUME

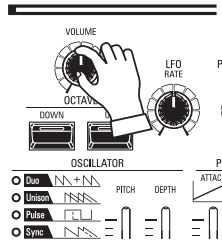
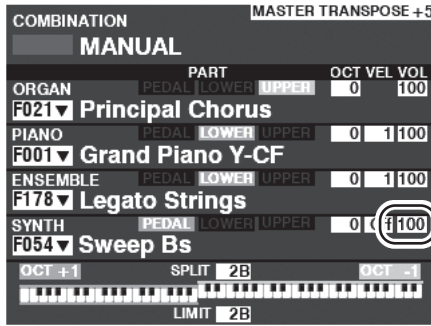

Use the [VOLUME] knob in the MONO SYNTH Section to adjust the volume.

NOTE: You can also adjust the volume of the MONO SYNTH Section in the PLAY screen by moving the cursor to “VOL” (right side of screen) and turning the [VALUE] knob.

CHANGING THE OCTAVE

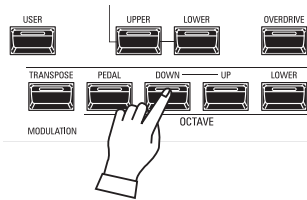
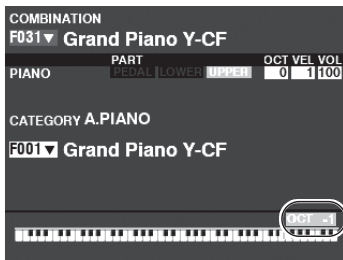

To change the Octave of the entire UPPER Keyboard (all Sections), press the OCTAVE [UP] or [DOWN] button. The display will show the current Octave setting.

NOTE: You can select “-2” (up to two octaves down) through +2” (up to two octaves up).

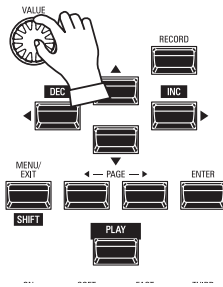
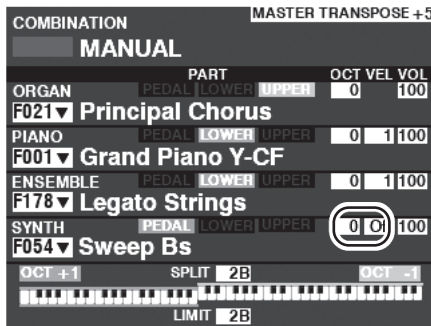

To change the Octave for the MONO SYNTH Section only, use the [DIRECTION] buttons to move the cursor to “PLAY Mode - MONO SYNTH Section - OCTAVE” and use the [VALUE] knob to change the Octave. The display will show the current Octave setting.

NOTE: You can select “-2” (up to two octaves down) through +2” (up to two octaves up).

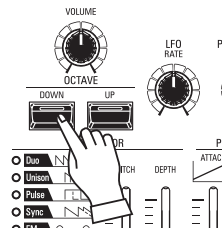
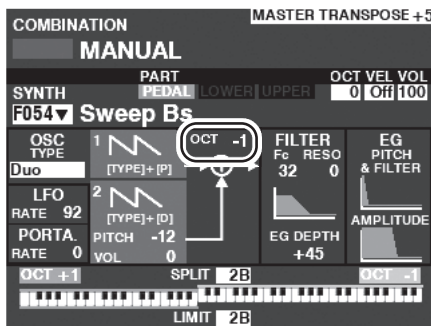

To change the Octave of the Oscillator, press the OCTAVE [UP] or [DOWN] buttons in the MONO SYNTH Section. The display will show the current Octave setting.

NOTE: You can select “-2” (up to two octaves down) through +2” (up to two octaves up).

These pages show an example of how to create a MONO SYNTH Patch.

SELECT [MANUAL]

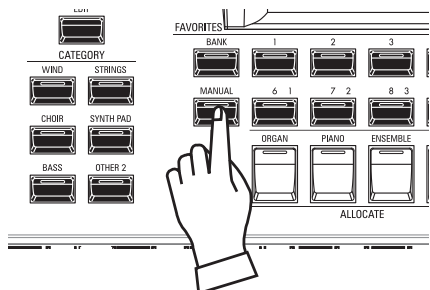

Normally, one of the [FAVORITE] buttons is “ON” (LED lit), indicating that a Combination has been selected. However, if you want to deselect Combinations and use the front panel controls entirely to control the sound, turn the [MANUAL] button “ON.” The [FAVORITE] buttons will all turn “OFF” and all sounds and features of the SK PRO will be controlled by the front panel controls as well as by the Advanced Feature settings from the Menu.

INITIALIZE “MANUAL”

Some Menu parameters may not be set the way you wish even if [MANUAL] is selected. If you encounter this, you can initialize the MANUAL parameters (P. 24).

ALLOCATE THE SECTION TO THE KEYBOARD

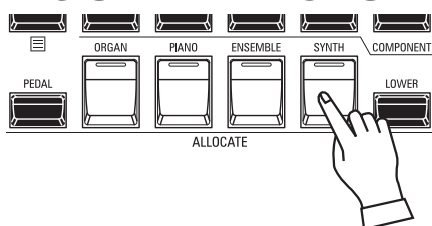

Press the [SYNTH] button in the [ALLOCATE] button group “ON.” The LED will light and the SYNTH Section will play from the keyboard.

LOCATE THE MONO SYNTH CONTROLS

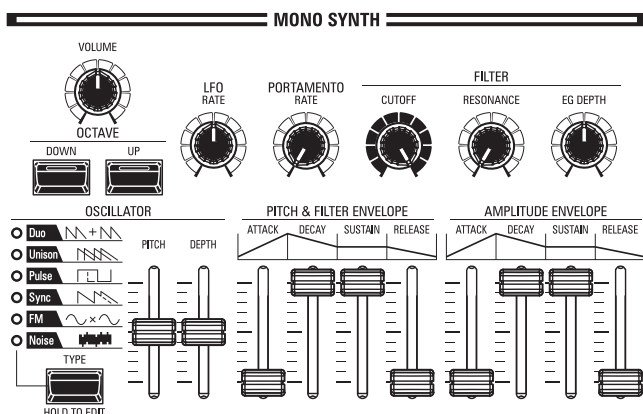

Use the controls in the MONO SYNTH portion of the Control Panel to create a MONO SYNTH Patch.

ADJUST THE VOLUME



Use the [VOLUME] knob in the MONO SYNTH Section to adjust the volume of the MONO SYNTH. Turn to the right to increase the volume and to the left to decrease the volume.

CHANGING THE OCTAVE

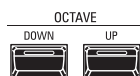

To change the Octave for the MONO SYNTH Section only, use the [DIRECTION] buttons to move the cursor to “PLAY Mode - MONO SYNTH Section - OCTAVE” and use the [VALUE] knob to change the Octave. The display will show the current Octave setting.

To change the Octave of the Oscillator, press the OCTAVE [UP] or [DOWN] buttons in the MONO SYNTH Section. The display will show the current Octave setting.

SELECT AN OSCILLATOR

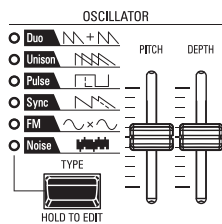

SELECT THE WAVEFORM (OSCILLATOR TYPE)

Use the [OSC TYPE] button to select the basic waveform.

ADJUST THE WAVEFORM (MODIFY)

Use the [PITCH] and [DEPTH] Slider Controls to modify the Pitch and Depth of the waveform you have selected.

NOTE: See (P. 48) for a fuller explanation of the Oscillator Types.

SLIDE THE PITCH (PORTAMENTO)

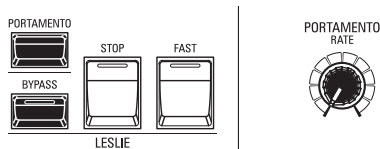

Use the PORTAMENTO [RATE] knob to adjust the rate of the Portamento.

NOTE: In order to hear the PORTAMENTO effect, both the [PORTAMENTO] button and the Portamento Patch Parameter must be "ON."

tips PORTAMENTO

"Portamento" allows you to slide smoothly from one note to another. It is often used in vocal performances or on instruments such as violin or trombone.

ADJUST THE BRIGHTNESS (FILTER)

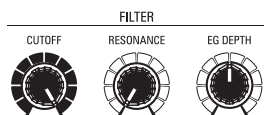

1 [CUTOFF] knob

Allows you to adjust the Cutoff Frequency of the filter, making the sound either brighter or more mellow.

2 [RESONANCE] knob

Allows you to add coloration to the sound by emphasizing the Cutoff Frequency.

3 [EG DEPTH] knob

Allows you to adjust the absolute level of the Cutoff Frequency of the filter.

CHANGING THE SOUND OVER TIME (ENVELOPE)

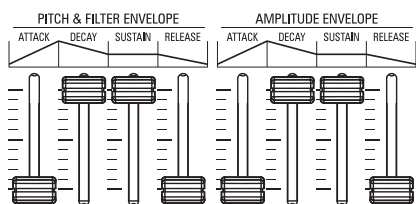

The Envelope Generator allow you to change the sound over time.

Amplitude..... Allows you to set the [AMPLITUDE] Envelope.

Filter Allows you to set the [PITCH&FILTER] Envelope, and set the changing depth ([EG DEPTH]) in the FILTER group.

Pitch..... Allows you to set the [PITCH&FILTER] Envelope, and set the changing depth ([PITCH EG DEPTH]) in the Patch parameters.

1 [ATTACK] slider

Allows you to set the rate at which the value rises from zero to maximum, beginning when a key is first pressed.

2 [DECAY] slider

Allows you to set the rate at which the value changes from the Attack level to the Sustain level.

3 [SUSTAIN] slider

Allows you to set the final level when a key is pressed and held.

4 [RELEASE] slider

Allows you to set the rate at which the value decays to zero when a key is released.

ADDING PERIODIC CHANGING (LFO)



Use the LFO (Low Frequency Oscillator) to add periodic audio effects such as Vibrato or Tremolo.

NOTE: In the default state, you can use the [MODULATION] wheel to control the LFO. Also, you can change various characteristics of the LFO such as Waveform, etc.

ADDING EFFECTS

You can add Multi-Effects such as Chorus, Delay, Overdrive, etc., to the MONO SYNTH sound. This is explained more fully under “Setting the Parameters” - “Mono Synth.”

SHOWING CURRENT SETTINGS

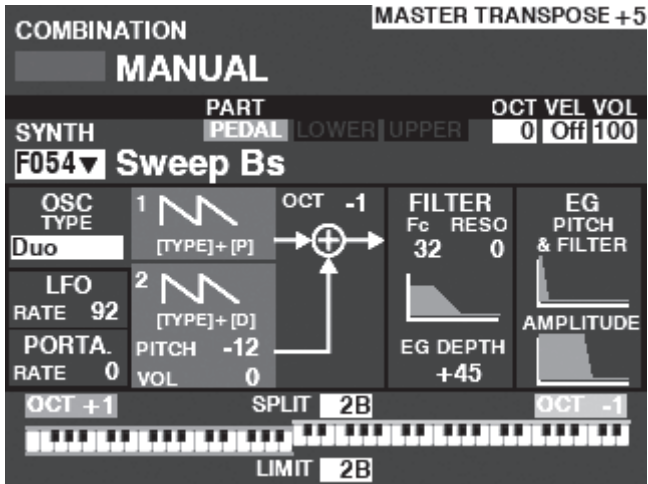

When you are in PLAY Mode, a page similar to the one shown at left will display if the MONO SYNTH Section only is selected via the [ALLOCATE] button or by repeatedly touching the [PLAY] button.

WHAT IS AN “OSCILLATOR?”

An **Oscillator** is the basic sound-producing unit of a synthesizer. There are several different types which produce different waveforms having different harmonic structures. These in turn can be manipulated in various ways to produce a wide variety of different musical effects.

The Mono Synth on the SK PRO follows the pattern of classic analog synthesizers. “Mono” is an abbreviation for “monophonic,” meaning that this Voice Section plays one note at a time. If multiple notes are played on the keyboard, only one note will sound. The Oscillator types available on the SK PRO are explained starting on the next page.

OSCILLATOR TYPES AND CHARACTERISTICS

The SK PRO has 6 audio oscillator settings which can be manipulated to produce a wide variety of tones. These are explained starting below.

DUO

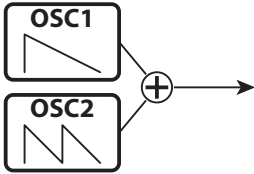

This setting utilizes two different pitched Oscillators. OSC1 sounds at “true pitch,” while OSC2 can be transposed up or down by one (1) octave in half-step increments. If the OSC2 LEVEL is set to “0,” only OSC1 will sound.

This Oscillator type is useful for Bass, Lead and “chord” effects.

| Parameter | Control | Description |
|-----------|----------------|---|
| PITCH | PITCH | Shift the OSC2 pitch (-12 - 0 - +12 by semitones) |
| VOLUME | DEPTH | Volume of the OSC2 (0 - 127) |
| OSC1 | [TYPE] + PITCH | Waveform of the OSC1 (Sawtooth, Square, Saw+Sqr) |
| OSC2 | [TYPE] + DEPTH | Waveform of the OSC2 (same as above) |

UNISON



This setting utilizes from one to seven Oscillators, one of which can be detuned against the other. It can be used for making celeste, chorus, or other purposely “out-of-tune” effects.

| Parameter | Control | Description |
|-----------|----------------|--|
| DETUNE | PITCH | De-tune depth (0 - 127) |
| LAYERS | DEPTH | Numbers of Oscillators (1 - 7) |
| OSC1 | [TYPE] + PITCH | Waveform of the OSC1 (Sawtooth, Square, Saw+Sqr) |
| OSC2 | [TYPE] + DEPTH | Waveform of the OSC2 (same as above) |

PULSE



A Pulse (or rectangular) waveform has a variable width known as the “duty cycle.” The sound can be modified by changing the pulse width or duty cycle. For example, a duty cycle of 50% will produce a clarinet-like sound while a duty cycle of 6% will yield a bright, brass-like tone quality.

| Parameter | Control | Description |
|------------|----------------|---|
| PW | PITCH | Pulse Width (0 - 127 as 50 - 90 [%]) |
| MOD DEPTH | DEPTH | Depth of the Pulse Width Modulation (0 - 127) |
| MOD SOURCE | [TYPE] + DEPTH | Modulating source (Pitch EG, LFO, Note) |

SYNC

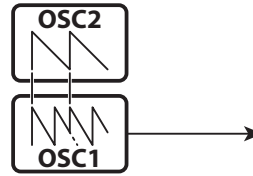

This setting utilizes two Oscillators which synchronize against each other to produce overtone effects.

| Parameter | Control | Description |
|------------|----------------|---|
| DETUNE | PITCH | De-tune depth of the OSC1 (0 - 127) |
| MOD DEPTH | DEPTH | Modulation depth of the OSC1 (0 - 127) |
| MOD SOURCE | [TYPE] + DEPTH | Modulating source (Pitch EG, LFO, Note) |

FM



This setting utilizes two Oscillators or “operators.” OSC1 is the “carrier tone” and OSC2 is the “modulating tone. You can create both “harmonic” and “inharmonic” tonal effects.

Adjusting the OSC2 pitch down creates wind-instrument sounds such as flute, brass, etc., while adjust the OSC2 pitch up is suitable for bell-like or “metallic” tones.

Setting the FB (feedback) at “Half” allows you to create string-type tones while “Full” is useful for unpitched or “noisy” tones.

| Parameter | Control | Description |
|-----------|----------------|---|
| RATIO | PITCH | Multiply of the OSC2 (0.5, 1 - 16) |
| MOD DEPTH | DEPTH | Modulation depth OSC2 to OSC1 (0 - 127) |
| FEEDBACK | [TYPE] + DEPTH | Feedback Level (Off, Half, Full) |

NOISE

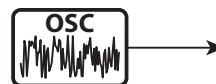

This setting creates unpitched sounds or “noise.” The sound changes from “noise” to “random pitched tones” by controlling the sampling rate.

A high sampling rate creates “seashore” type effects, a slightly lower rate yields a “noisy percussion”, and a still lower rate creates effects suggestive of a “retro science fiction movie.”

| Parameter | Control | Description |
|------------|----------------|---|
| RATE | PITCH | Sampling Rate (0 - 127) |
| MOD DEPTH | DEPTH | Modulation depth to the sampling rate (0 - 127) |
| COLOR | [TYPE] + PITCH | Noise color (Red, Pink, White) |
| MOD SOURCE | [TYPE] + DEPTH | Modulating source (Pitch EG, LFO, Note) |

You can play in a variety of different styles by allocating the 4 Voice Sections as well as the “3 PART ORGAN” feature of the ORGAN Section to each keyboard. This is explained in more detail starting below.

SECTIONS AND KEYBOARDS

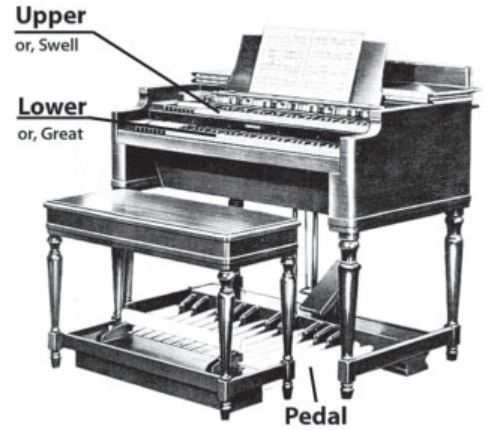
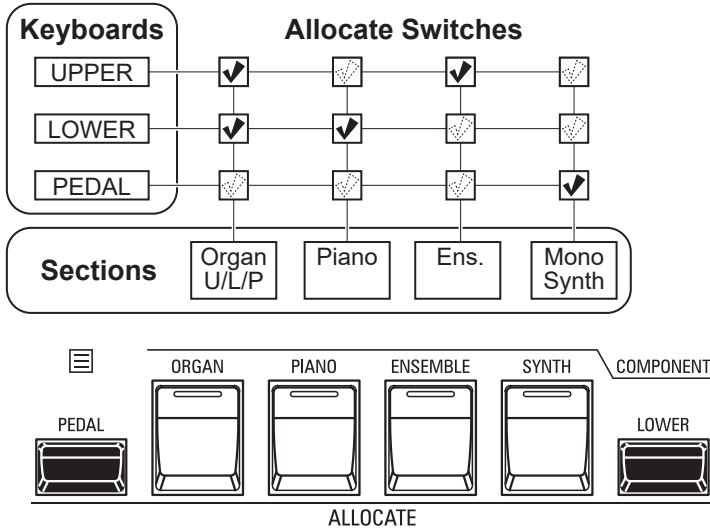

The SK PRO/SK PRO-73 contains 4 Voice Sections - ORGAN, PIANO, ENSEMBLE and MONO SYNTH. These can be played by turning the [ALLOCATE] button for each Section “ON.” In addition, the ORGAN Section has 3 Parts - UPPER, LOWER and PEDAL to replicate the performance of a classic Hammond Organ with two manuals and pedals.

ALLOCATING THE SECTIONS

- UPPER**..... Press the [ALLOCATE] button for the desired Section “ON.” The LED will light red.
- LOWER**..... Press and Hold the [LOWER] button and turn the [ALLOCATE] button for the desired Section “ON.” The LED will light green.
- PEDAL**..... Press and Hold the [LOWER] button and turn the [ALLOCATE] button for the desired Section “ON.” The LED will light green while the [PEDAL] button is pressed.
- ALLOCATING TWO OR MORE SECTIONS TO THE SAME KEYBOARD**... Press the desired Section buttons simultaneously. The figure below shows switching on both PIANO and ENSEMBLE Sections.

tips [ORGAN] BUTTON LIGHTS ORANGE

When the 3 PART ORGAN feature is used, the ORGAN Section is allocated to multiple keyboards. In this case, the LED in the [ALLOCATE] button in the ORGAN Section will light orange.

KEYBOARD SPLIT

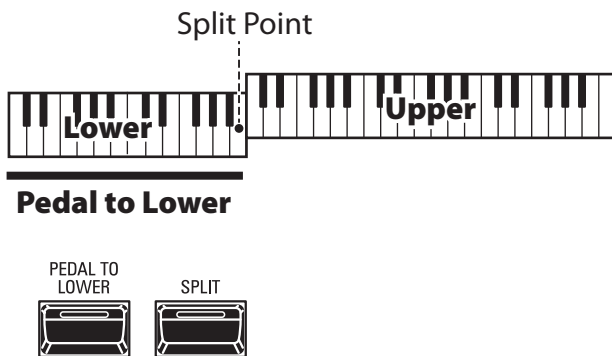

The SK PRO is a single-keyboard instrument, but by using the SPLIT feature it can be made to perform as if it were a two-manual instrument.

tips DIFFERENCE BETWEEN “ALLOCATE” AND “PEDAL TO LOWER”

When you allocate a Section to Lower, it works as typically keyboard instrument as same as Upper. The PEDAL TO LOWER features for “sounding bass note with chord playing.” You can sounding the Pedal part for lowest note or root note of the chord, and ranging the Pedal part for playing by both hands on the keyboard.

USING THE SPLIT FEATURE

To enable the SPLIT feature, press the [SPLIT] button “ON.” The LED will light. When SPLIT is active the left portion of the keyboard is referred to as LOWER while the right portion of the keyboard is UPPER.

NOTE: You can change the Split Point. This is explained more fully in the Owner’s Manual.

CHANGING THE OCTAVE

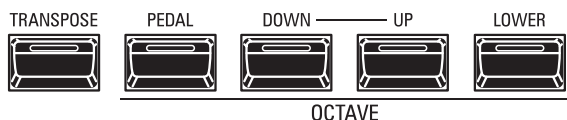

To change the Octave for each keyboard,

UPPER.....Press the OCTAVE [DOWN] or [UP] button.

LOWERPress and Hold the [LOWER] button and press the OCTAVE [DOWN] or [UP] button.

PEDAL.....Press and Hold the [PEDAL] button and press the OCTAVE [DOWN] or [UP] button.

The current Octave setting is shown in the display. The button LEDs on the buttons will light if the Octave setting is not “0.”

NOTE: You can set the Octave for each section. This is explained more fully in the Owner’s Manual.

PEDAL TO LOWER

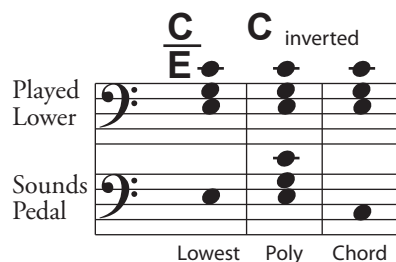

The **PEDAL TO LOWER** feature allows you to play the Pedal Part from the LOWER Keyboard (left portion of the keyboard when [SPLIT] is active, or expanded MIDI keyboard).

To engage PEDAL TO LOWER, press the [PEDAL TO LOWER] button and lights ON.

NOTE: You can adjust the sounding range or condition of the PEDAL TO LOWER feature. This is explained more fully in the Owner’s Manual.

PEDAL SUSTAIN

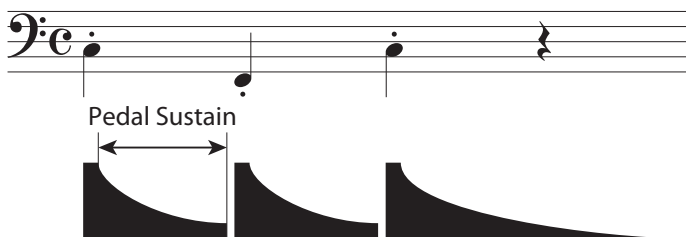

The SK PRO incorporates a feature called **Pedal Sustain**. When this feature is active, the Pedal tones will smoothly decay upon release, much in the manner of a string bass.

The Pedal Sustain is controlled from the INTERNAL ZONE FUNCTION Mode.

NOTE: The parameters described in the above paragraphs are Combination parameters, meaning they can be saved with different settings in different Combinations.

ADJUSTING THE SOUND DURING PERFORMANCE⁵¹

There are a number of adjustments you can make to the sound during performance. This is explained in more detail starting below.

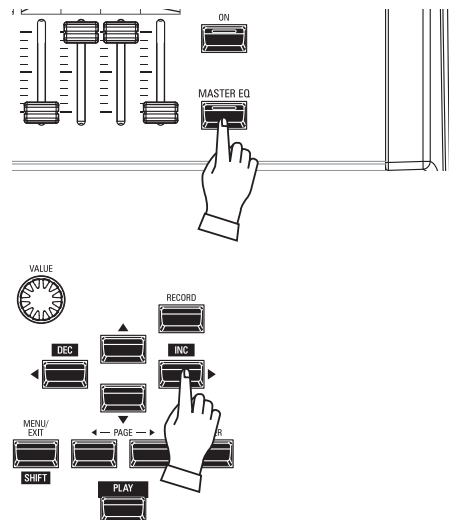
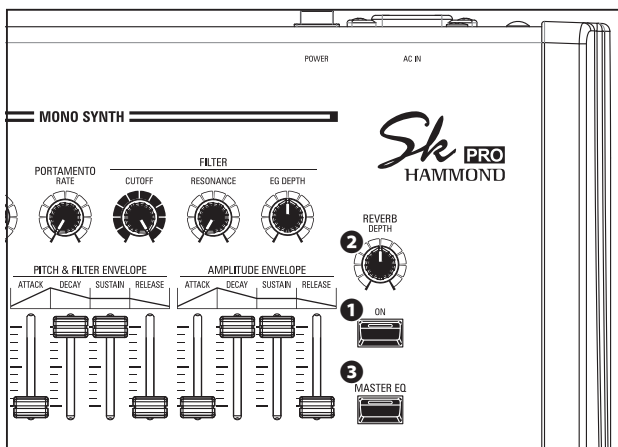

REVERB

REVERB (or Reverberation) is the prolongation or persistence of sound caused by sound bouncing or reflecting off of hard surfaces such as floors, walls or ceilings. It is measurable by the interval of time required for the sound to decay to inaudibility after the source of the sound has been stopped.

The SK PRO has built-in Digital Reverb which allows you to simulate several different acoustic profiles representing different sizes and types of enclosures.

① [REVERB ON] button (Co)

Turns the Reverb effect “ON”(LED lit) and “OFF.”

② [REVERB DEPTH] knob (Co)

Adjusts the amount of the selected Reverb Type.

NOTE: You can adjust the Reverb depth for each Section (MENU - PATCH EDIT - COMBINATION). This is explained more fully in the Owner’s Manual.

NOTE: You can adjust the Reverb Type, Depth and Time. This is explained more fully in the Owner’s Manual.

NOTE: These parameters are marked “Co,” meaning they are Combination parameters.

MASTER EQUALIZER

The Master Equalizer allows you to adjust the overall tonal quality for all Voice Sections of the entire instrument.

③ [MASTER EQ ON] button (Sys)

To enable the Master Equalizer, press the [MASTER EQ] button “ON.” The LED will light.

The Master Equalizer parameters can be adjusted in the MASTER EQUALIZER Menu.

In addition, each Voice Section has an EQUALIZER Page in its FUNCTION Mode if you wish to adjust the tone quality of an individual Voice Section.

NOTE: This parameter is marked “Sys,” meaning it is a System Parameter common to all Combinations and Patches.

ADJUSTING THE MASTER EQUALIZER

The MASTER EQUALIZER Menu allows you to adjust the overall frequency response of the entire instrument.

① LOCATE THE MASTER EQUALIZER MENU

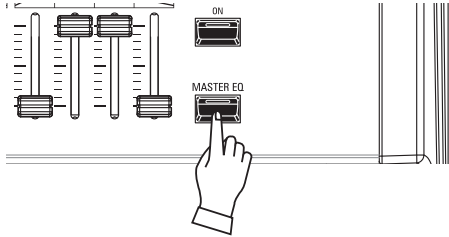

Press and hold the [MASTER EQ] button. The display will show the “MASTER EQUALIZER” Menu Page.

② SELECT THE BAND

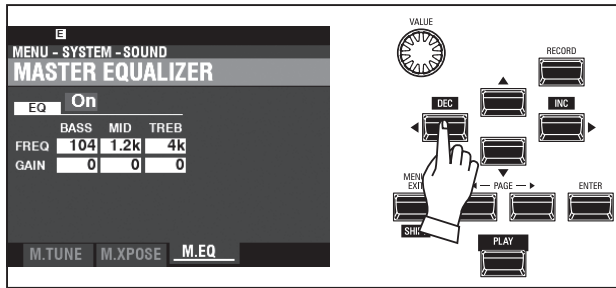

Use the [DIRECTION] buttons to move the cursor to the band you wish to adjust (BASS, MID, or TREBLE).

③ SELECT THE VALUE

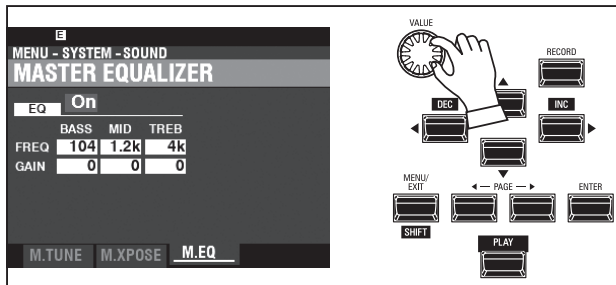

Use the [VALUE] knob to select the desired setting for the selected frequency band.

④ RECORD THE SETTING

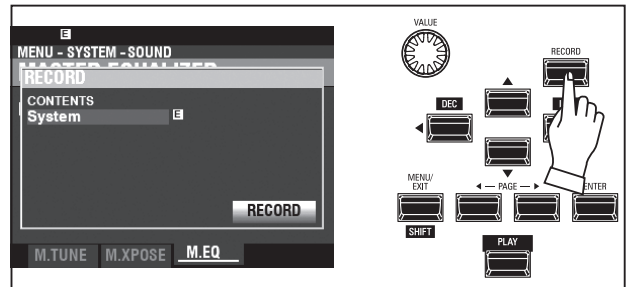

After you have made your adjustments to the Master Equalizer, you can save your settings to be remembered the next time you turn the SK PRO Power “ON.” To do this: press the [RECORD] button from the previous Menu Page to enter RECORD mode.

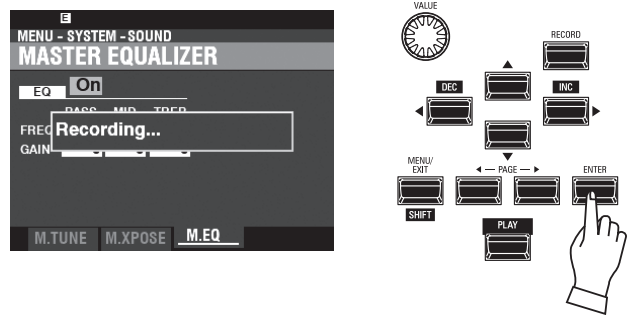

Use the [▼] button to move the cursor to the [RECORD] icon and press the [ENTER] button. The display will show “Recording...” for approximately 1 second.

⑤ RETURN TO PLAY MODE

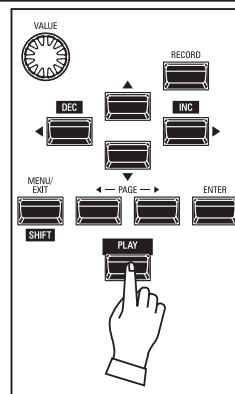

After doing the above, press the [PLAY] button to return to the PLAY Mode.

TRANPOSE, TUNE

These features allow you to shift the musical key and the overall tuning of the entire instrument.

TRANSPOSING THE ENTIRE KEYBOARD

TRANPOSE will step either up or down six (6) semitones or half-steps from the center position. This is useful if you have a piece of music written in one key but which needs to sound in another key. The TRANPOSE feature consists of the [TRANPOSE] Touch Button, plus the [DOWN] and [UP] Touch Buttons to the right of the [TRANPOSE] Touch Button. The [DOWN] Touch Button allows you to transpose lower and the [UP] Touch Button allows you to transpose higher.

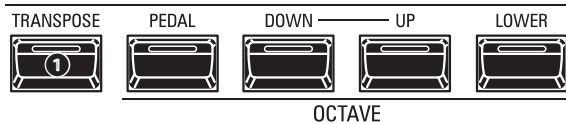

1 [TRANPOSE] button

- To raise the pitch, press the [UP] button, while holding down the [TRANPOSE] button.
- To lower the pitch, press the [DOWN] button, while holding down the [TRANPOSE] button.

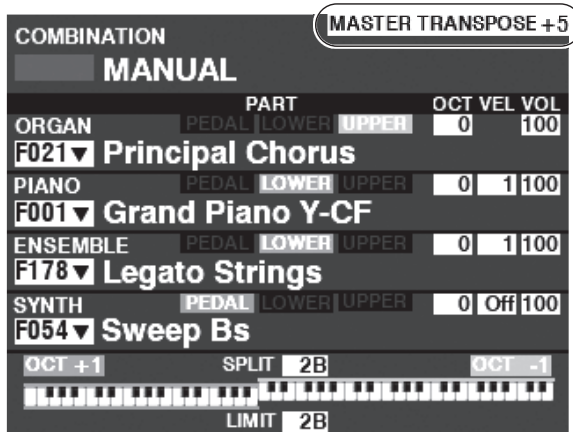

In the above example, the TRANPOSE value is set at "+5" - if a "C" key is depressed, a note five (5) half-steps higher will sound ("F").

When performing this operation, the status of the transposition is shown in the display. The [TRANPOSE] LED will light "ON" if the value is not "0."

WHAT IS AFFECTED BY THE TRANPOSE FUNCTION?

TRANPOSE will affect:

- The internal sounds of the instrument.
- MIDI IN Note Data.
- MIDI Note Data sent OUT to the External Zones.

NOTE: TRANPOSE is a temporary parameter, and is not recorded to any Patch or Combination. When the power to the instrument is turned "OFF," it resets to 0.

NOTE: You can select whether Transpose changes while notes are being held or when the next note is pressed after releasing the notes being held.

MASTER TUNE

This parameter changes the overall tuning pitch of the entire instrument. The reference pitch is “A-440.” The selectable range is from “A-430” through “A-450.”

① LOCATE “MASTER TUNE”

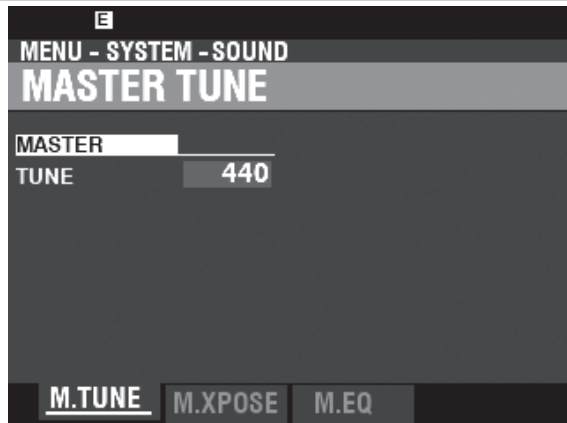

1. From the PLAY Mode, press the [MENU/EXIT] button to enter MENU Mode.
2. Press the [▶] button two times to locate the SYSTEM Menu. “SOUND” should be highlighted.
3. Press the [ENTER] button to see the MASTER TUNE Menu.

② SELECT THE VALUE

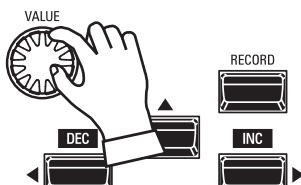

Use the VALUE Rotary Control to the right to raise the pitch.
Use the VALUE Rotary Control to the left to lower the pitch.

③ SAVE THE SETTING

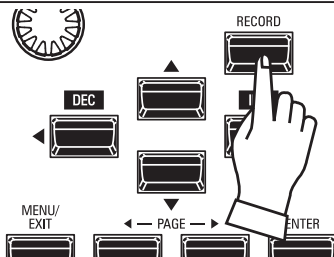

You can Save this setting to be remembered at the next power “ON.” To do this:

1. Press the [RECORD] button from the MASTER TUNE page. You will see ‘System’ highlighted.
2. Press the [ENTER] button. The MASTER TUNE parameter has been saved.

④ RETURN TO PLAY MODE

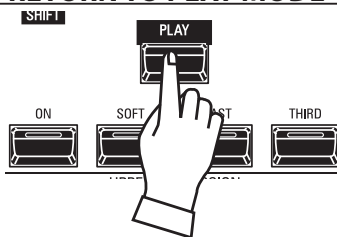

Press the [PLAY] button to return to the PLAY Mode.

The current settings can be recorded to a Combination or Patch. This is explained in more detail starting below.

HOW TO RECORD

① PRESS [RECORD]

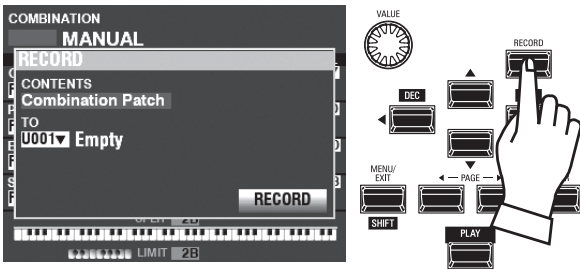

Press the [RECORD] button at each Section or Combination page. The screen shown above will appear.

② SELECT THE CONTENT

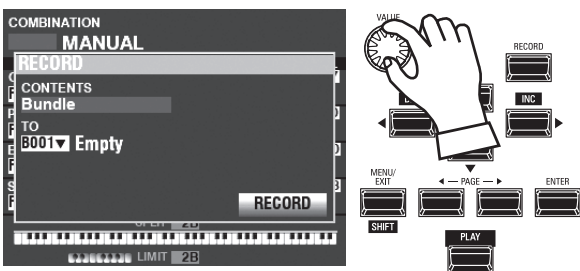

Use the [VALUE] knob to select the content to record (Combination or Section). Press [ENTER] to confirm.

For his example, select “BUNDLE,” which records multiple contents simultaneously.

NOTE: Combinations, Patches and Sections are explained on page 20).

NOTE: If edits have been made to a Combination or Patch, an “E” will appear at the top of the display.

③ SELECT THE NUMBER TO RECORD

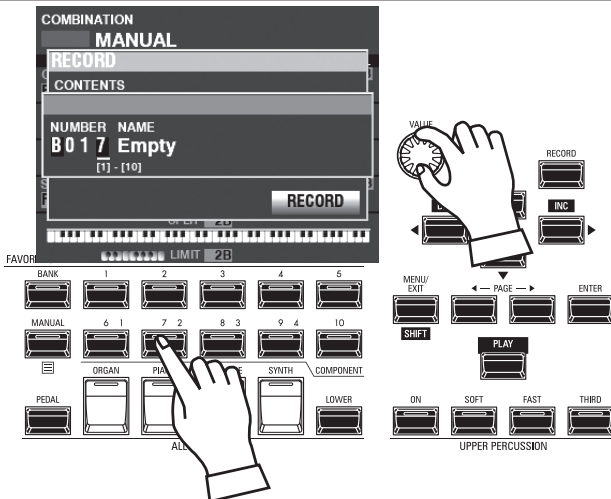

Move the cursor to “TO.”

Use the [VALUE] knob to select the number to record, or use the Number buttons to type the number, and press [ENTER].

Move the cursor to the [RECORD] icon, and press the [ENTER] button to confirm.

④ NAME THE CUSTOM SETTING

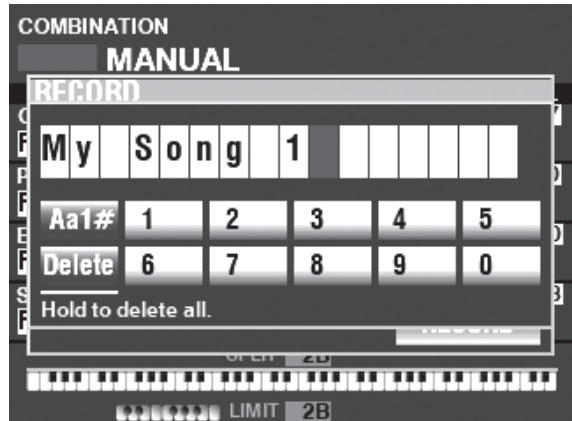

Enter the name.

[Aa1]..... Toggle between capital and lower-case letters

[1] - [10] Select the displayed character.

[Insert] Insert a space to the cursor position.

[Delete] Delete a letter at the cursor position.

[VALUE] Move the cursor to the character to be edited.

[ENTER] Confirm the name.

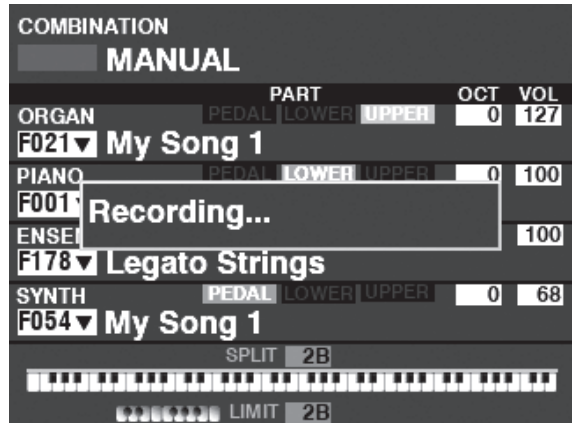

The message “Recording...” shown above will display for approximately 1 second.

NOTE: Do not turn the power “OFF” while the above message is displaying.

NOTE: If you DO NOT wish to record, press the [MENU/EXIT] or [PLAY] button instead of the [ENTER] button.

⑤ RETURN TO PLAY MODE

Press the [PLAY] button to return to the PLAY Mode.

tips RECORDING METHOD

Each portion of the SK PRO is recorded separately - “Combination” and “Patch” for voices and “Custom” for Tone Wheel, Pipe or Leslie Cabinets. If you wish to record the entire contents of the instrument, you can save them as a Setup.

“BUNDLE” records the contents of a Combination and ORGAN and MONO SYNTH Patches simultaneously.

USING THE DISPLAY

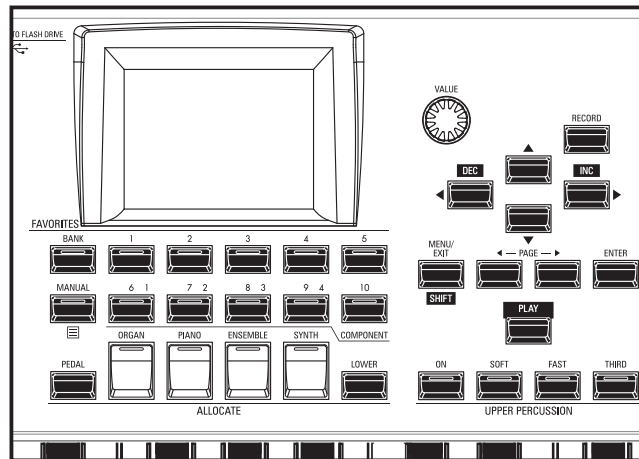

The display has three (3) Modes - PLAY Mode, MENU Mode and FUNCTION Mode. The next pages explain how to read the display in each Mode.

PLAY MODE

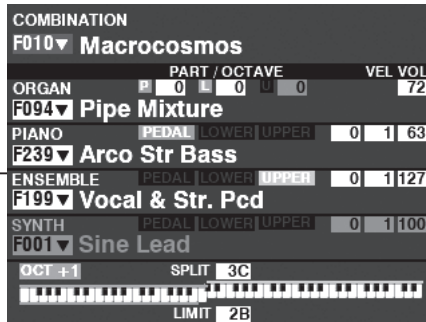

The PLAY Mode allows you to see or modify the current basic settings such as Drawbar settings, Combination Numbers, Patch Numbers and other information.

MENU MODE

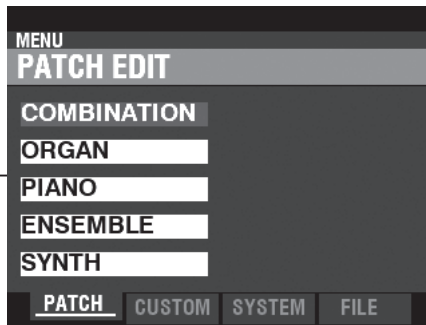

The MENU Mode allows you to see the different FUNCTION Modes where you can customize the instrument.

FUNCTION MODE

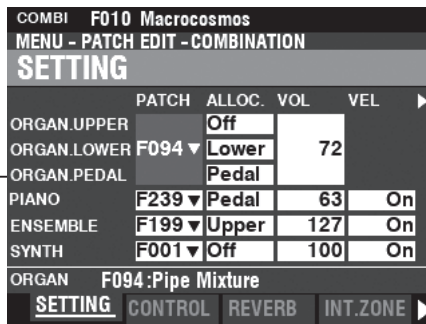

The FUNCTION Mode allows you to change specific parameters within each MENU Mode.

The PLAY Mode is the normal performance mode. The information necessary for ordinary performance will be displayed.

TO LOCATE THIS MODE:

The PLAY Mode is automatically displayed when the instrument is first powered “ON” and the opening screen disappears. Press the [PLAY] button if another mode is displayed.

PLAY MODES



General

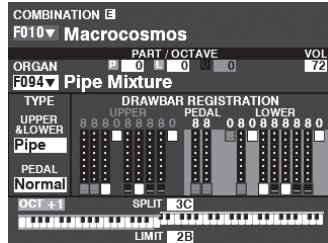

ORGAN Section



PIANO Section / ENSEMBLE Section

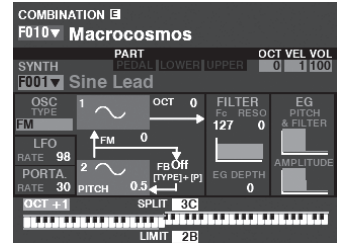

MONO SYNTH Section

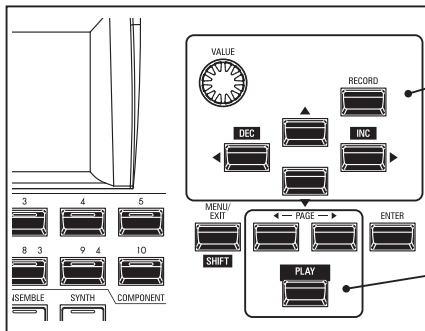

Each PLAY Mode allows you to select the Combinations or Patches and adjust the parameters most frequently used.

The PLAY Modes are selected by the [PLAY] or PAGE [◀/▶] buttons.

HOW TO READ THE DISPLAY (COMBINATION)

When two or more Voice Sections are “ON,” the names will be highlighted in the display. If a Voice Section is “OFF” ([ALLOCATE] button LED not lit), the Voice name will still display but will be “greyed out.” In addition, parameters such as Octave, etc., will only display if their values are different from their default settings.

HOW TO READ THE DISPLAY (ORGAN SECTION)

If the ORGAN Section only is used ([ALLOCATE] button "ON"), a screen similar to the one below will display.

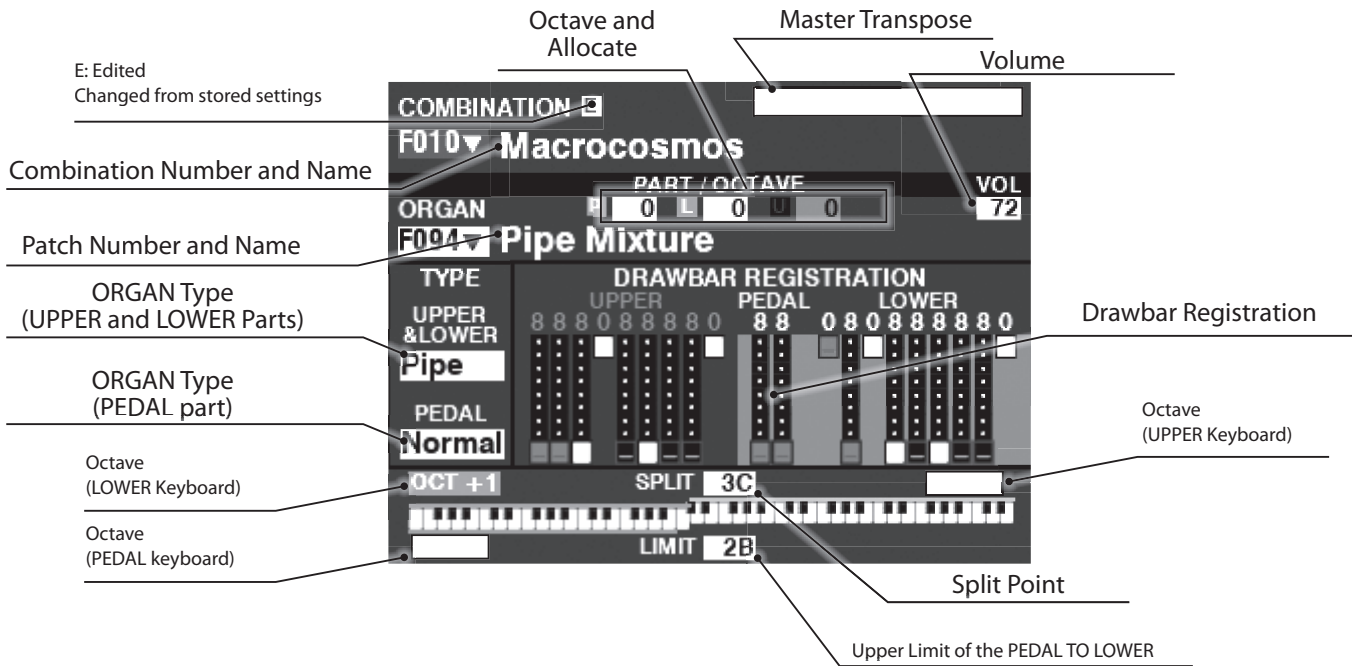

HOW TO READ THE DISPLAY (PIANO/ENSEMBLE SECTION)

If either the PIANO or ENSEMBLE Section only is used (PIANO or ENSEMBLE [ALLOCATE] button "ON"), a screen similar to the one below will display.

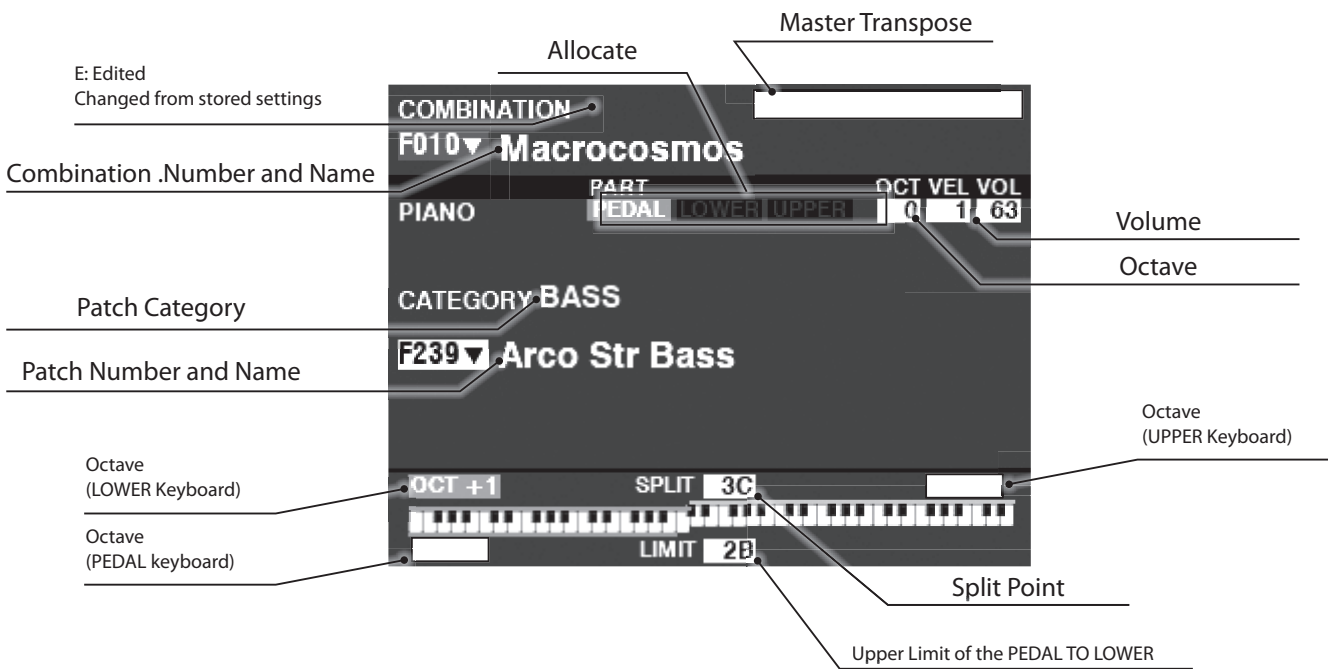

HOW TO READ THE DISPLAY (MONO SYNTH SECTION)

If the MONO SYNTH Section only is used (SYNTH [ALLOCATE] button "ON"), a screen similar to the one below will display.

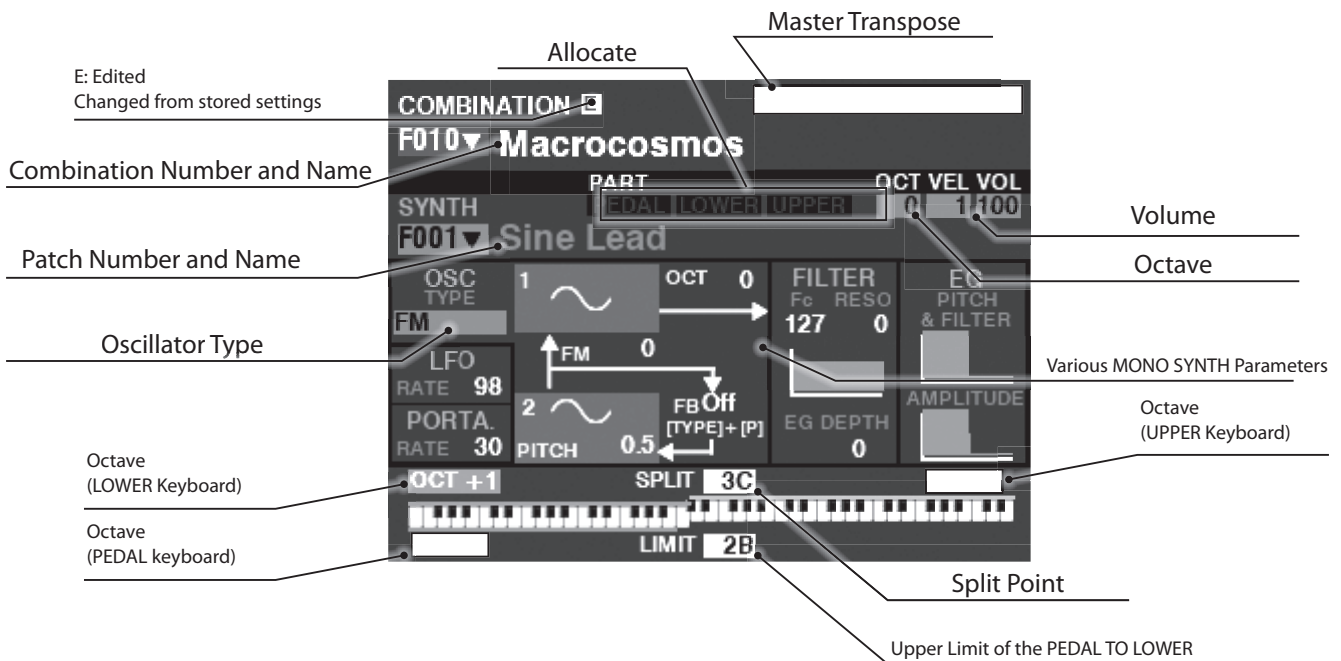

APP MENU

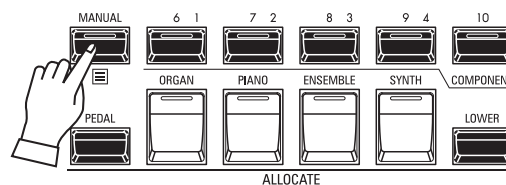
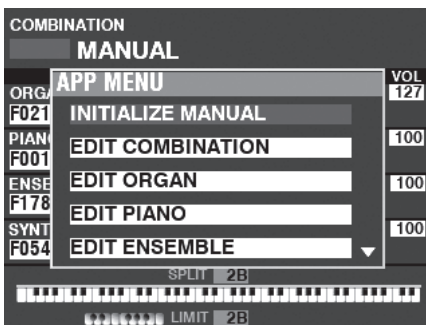

The APP (Application) Menu allows you to select various Menu Pages quickly. To display the APP Menu, Touch and Hold the [=] button.

- The following Menu options will display:
- INITIALIZE [MANUAL]**Initialize the MANUAL parameters.
 - EDIT COMBINATION**Enter the Combination edit page.
 - EDIT ORGAN**Enter the Organ edit page.
 - EDIT PIANO**Enter the Piano edit page.
 - EDIT ENSEMBLE**Enter the Ensemble edit page.
 - EDIT SYNTH**Enter the Mono Synth edit page.
 - DELETE COMBINATION**Delete selected Combination.

To select an option:

1. Use the [▲]/[▼] buttons to highlight the option you want.
2. Press the [ENTER] button to select the desired option.

tips APP MENU

The number of options displayed by the APP Menu depends on how many Voice Sections are active. For example, if only the ORGAN Section is active (ORGAN [ALLOCATE] button "ON"), the other Voice Menus will not display. To see the APP Menu as it appears at the left, turn all four Voice Sections "ON" ([ALLOCATE] LED's lit).

MENU MODE

As explained earlier, the MENU Mode allows you to see the different FUNCTION Modes where you can customize the instrument.

TO LOCATE THIS MODE:

Press the [MENU/EXIT] button.

The MENU Mode has four Pages. Use the PAGE [◀]/[▶] buttons to scroll through the Pages, select the item using the [DIRECTION] buttons, and [ENTER] button to enter the desired FUNCTION Mode.

HOW TO READ THE DISPLAY

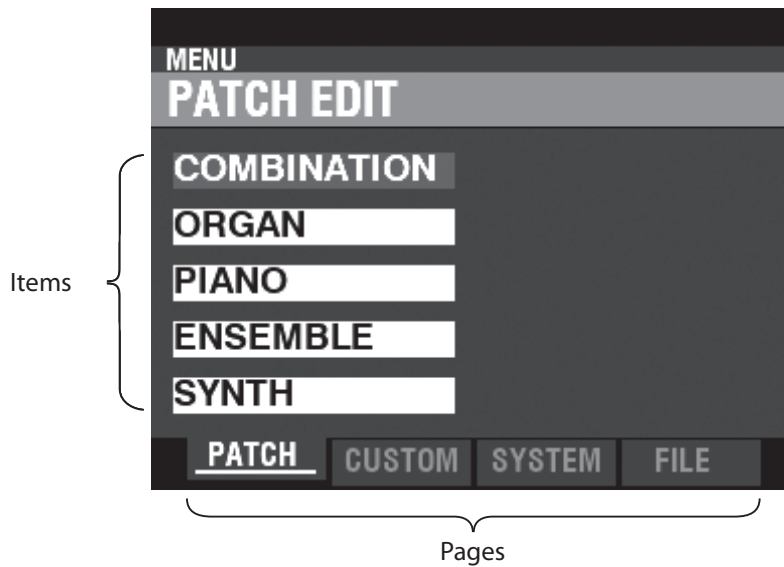

OPERATION IN THIS MODE

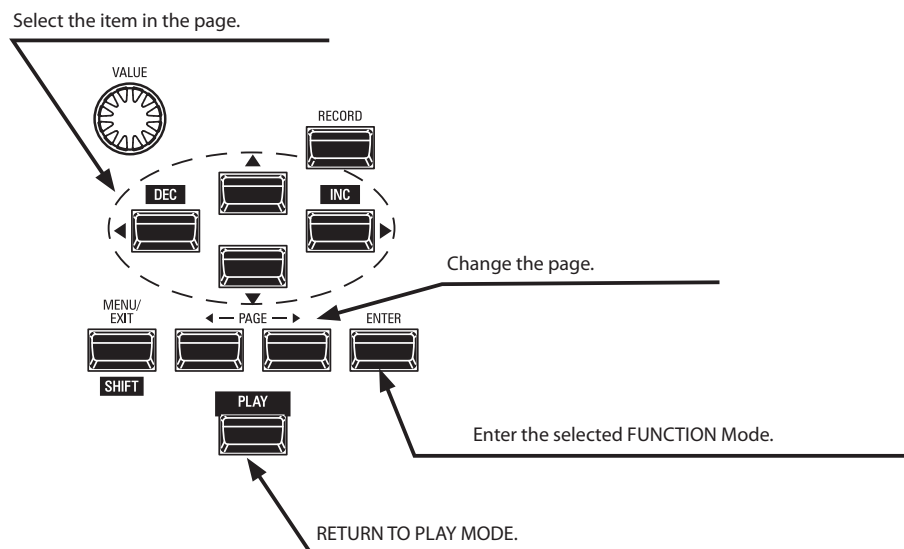

MENU MODE CONTENTS

This is explained more fully in the Owner's Manual.

PATCH

1. COMBINATION

Allows you to edit the current Combination.

2. ORGAN

Allows you to edit the current Organ registration.

3. PIANO

Allows you to edit the currently selected voice in the PIANO Section.

4. ENSEMBLE

Allows you to edit the currently selected voice in the ENSEMBLE Section.

5. SYNTH

Allows you to edit the current MONO SYNTH parameters.

CUSTOM

1. TONE WHEEL

Allows you to edit the characteristics of the Tone Wheel Organ.

2. PEDAL REG.

Allows you to edit the harmonics used by the Pedal Drawbars of the Tone Wheel Organ.

3. LESLIE

Allows you to edit the inbuilt Leslie effect.

4. PIPE

Allows you to select and edit each Pipe Organ Stop.

SYSTEM

1. SOUND

Allows you to set Master Tune, Transpose, and Master Equalizer.

2. AUDIO

Allows you to set the audio configuration between Voice Sections and output jacks.

3. CONTROL

Allows you to set the parameters for the various controllers such as Foot Switch, Expression Pedal, Display and Keyboard.

4. PATCH LOAD

Allows you to choose which contents are loaded when a Combination is selected.

5. FAVORITE

Allows you select and edit Favorites.

6. MIDI

Allows you to set MIDI channels, and various messages for the MIDI port and the USB MIDI.

7. GLOBAL

Allows you to set the Auto Power Off time and select USB Mass Storage.

8. DELETE

Allows you to delete "U" (User) contents.

9. DEFAULT

Allows you to initialize part or all of the instrument to factory settings.

10. INFORMATION

Allows you to see the status of peripheral devices and software versions. Also allows you to updates the system software of the instrument.

FILE

1. LOAD

Allows you to Load Setups, Patches or Custom File from either an external device such as a USB Flash drive or the Internal Memory into the instrument.

2. SAVE

Allows you to Save Setups, Patches, Custom Files, etc., either to an external device such as a USB Flash drive or the Internal Memory into the instrument.

3. DELETE

Allows you to Delete Setups, Patches or Custom Files, either from an external device such as a USB Flash drive or from the Internal Memory of the instrument.

4. FORMAT

Allows you to initialize either an external device such as a USB Flash drive or the Internal Memory of the instrument.

FUNCTION MODE

The FUNCTION Mode allows you to set and adjust the various parameters. This is explained in more detail starting below.

HOW TO READ THE DISPLAY

Section, E(Edited) mark, Combination/Patch Number and Name.

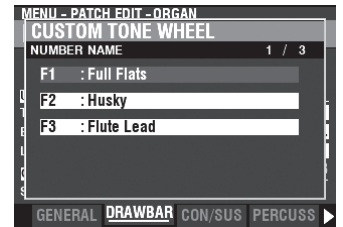
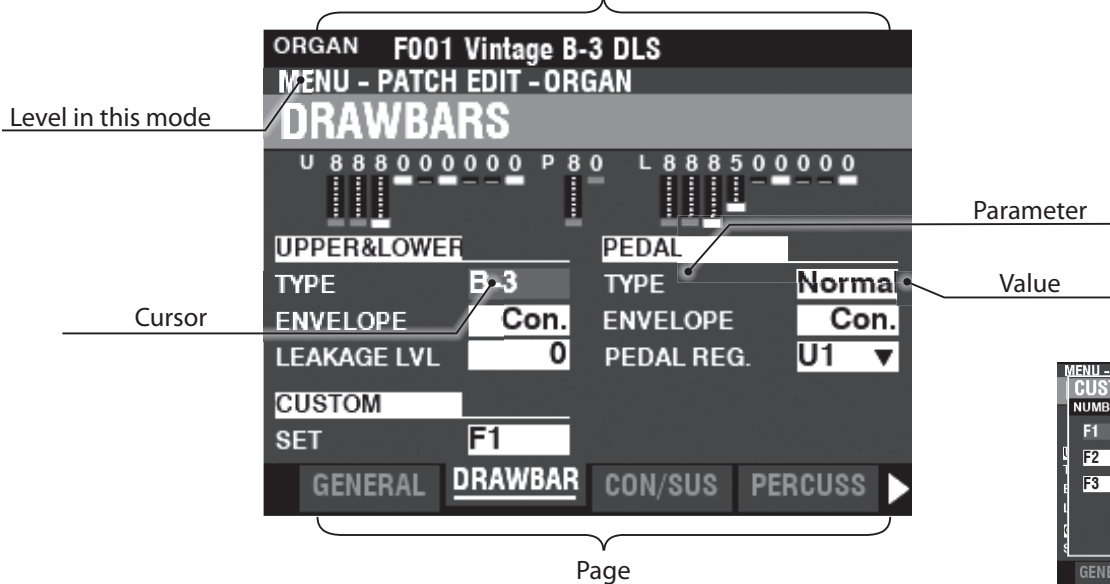

tips CHANGING PARAMETERS

The "▼" to the right indicates more than one choice is available.

The following is an example of how to change parameters to your liking. This example shows how to select a Custom Tone Wheel Set.

To select a Custom Set:

1. Move the cursor to CUSTOM and press [ENTER]. You will see the window shown above.
2. Use the [VALUE] knob or the [DEC]/[INC] buttons while holding the [SHIFT] button to highlight the desired Custom Set.
3. Press the [ENTER] button to select the desired Custom Set. The above window will close after you have made your selection.

OPERATION IN THIS MODE

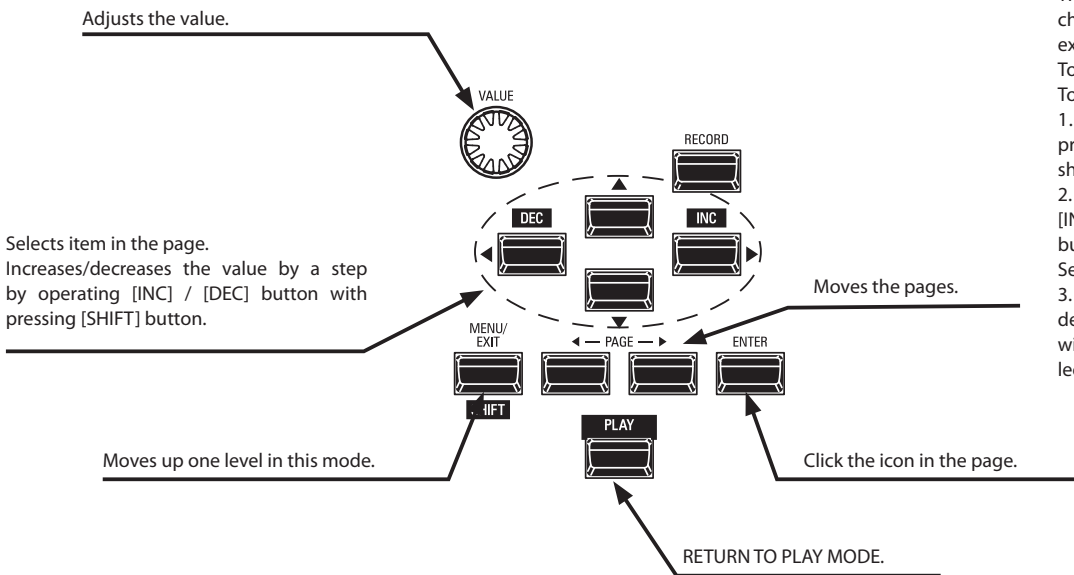

APP MENU

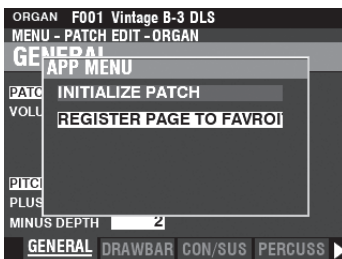

The PLAY Menu and several of the FUNCTION Mode Menu contain an additional APP Menu which you can use to access various functions quickly. Touch and Hold the [≡] button to see the APP Menu for the particular Menu or Mode.

To select an item in an APP Menu:

1. Use the [▲]/[▼] buttons to highlight the option you want.
2. Press the [ENTER] button.

EXAMPLE OF OPERATION

① GO TO THE MENU MODE

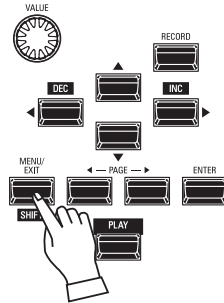
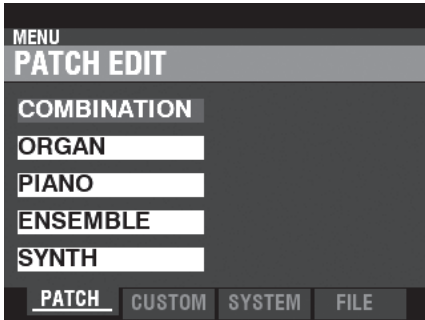

This example will show you how to adjust the Percussion Decay Time when the [FAST] button is selected. Press the [MENU/EXIT] button. The MENU Mode will appear.

② MOVE THE PAGE IN THE MENU MODE

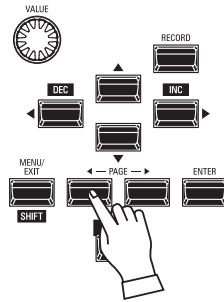
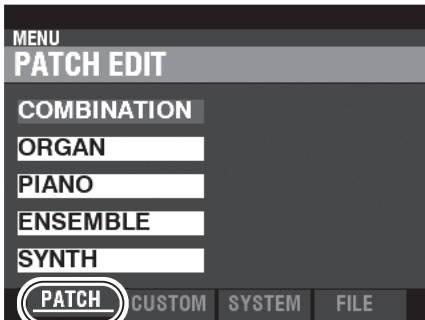

Use the [◀]/[▶] buttons to select the different Pages in each Menu.

For this example, the PATCH Edit Menu is already displayed so it is not necessary to touch either of the [◀]/[▶] buttons.

③ SELECT THE ITEM IN THE PAGE

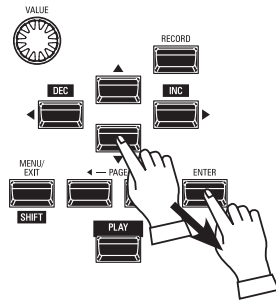
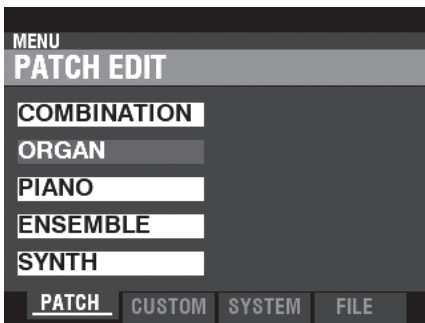

Use the [DIRECTION] buttons to select the item to edit.

For this example, press the [▼] button to select “ORGAN.”

Press the [ENTER] button to select each FUNCTION Mode. For this example, touch [ENTER] after selecting “ORGAN” above.

④ MOVE THE PAGE IN THE FUNCTION MODE

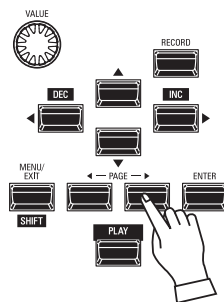
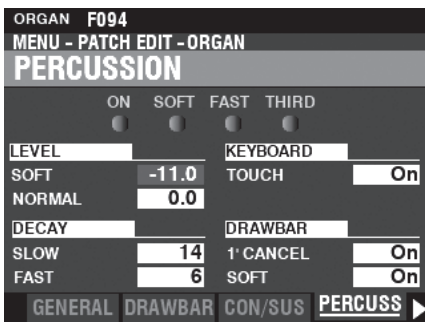

Use the [◀]/[▶] buttons to select the individual FUNCTION Mode Menu you want to edit.

For this example, press the [▶] button three times to select the PERCUSS (Percussion) Menu Page.

64 FUNCTION MODE - CONTINUED

⑤ MOVE THE CURSOR TO THE PARAMETER

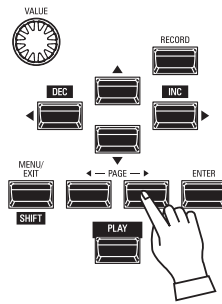
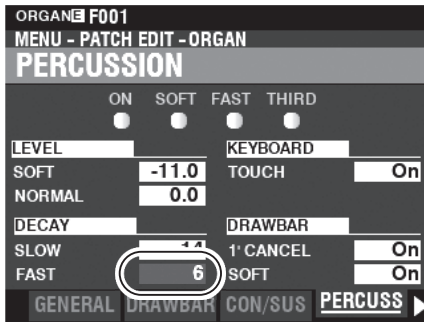

Use the [DIRECTION] buttons to move the cursor to the parameter you wish to adjust. For this example, select “DECAY FAST.”

⑥ CHANGE THE VALUE

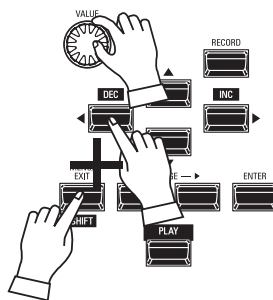
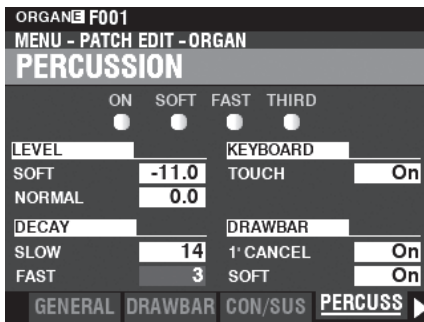

Use the [VALUE] knob to change the highlighted value. For this example, decrease the value by turning the [VALUE] knob to the left.

NOTE: You can also change values by using the [DEC] / [INC] buttons while pressing and holding the [SHIFT] button.

NOTE: To change other parameters, repeat steps 1 through 6 above.

⑦ RECORD THE PATCH

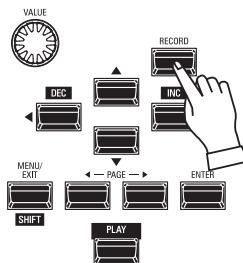

These settings are “temporary,” and will not be remembered if another Patch or Combination is selected, or if the instrument is turned “OFF.”

To Save your settings:

1. Press the [RECORD] button. You will see the selected item appear in the display (“Organ Patch” in this example”).

2. Press the “▼” button two times to select RECORD and press the [ENTER] button. Your settings have been saved.

⑧ RETURN TO PLAY MODE

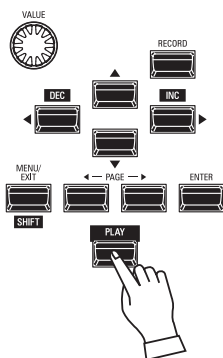
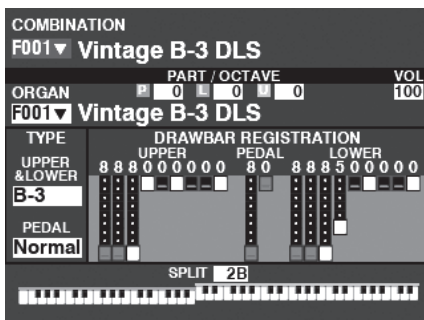

Press the [PLAY] button to return to the PLAY Mode.

To make programming quicker and easier, many of the buttons on the Control Panel can be used to access the FUNCTION Mode associated with that button instantaneously. Pressing and holding any of the buttons on the top panel automatically “shortcuts” the display to the related FUNCTION Mode.

SHORTCUT EXAMPLE:

LOCATE THE PERCUSSION FUNCTION MODE

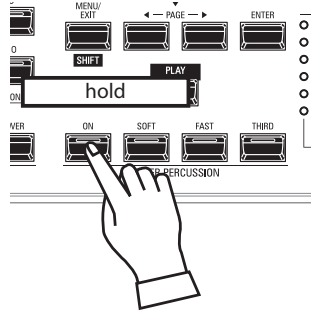
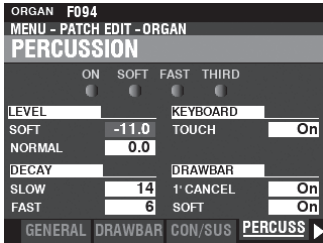

If you wish to edit the Percussion settings, Press and Hold any of the four Percussion buttons ([ON], [SOFT], [FAST], or [THIRD]) and the display will immediately show the Percussion FUNCTION Mode.

NOTE: You can change the Display Shortcut time. This is explained more fully in the Owner's Manual.

IF YOU FREQUENTLY USE A CERTAIN PAGE...

You can assign a frequently-used FUNCTION Mode to one of the [FAVORITE] buttons for immediate access, even if that particular FUNCTION Mode is not normally accessible via a Shortcut.

REGISTER

① LOCATE THE PAGE

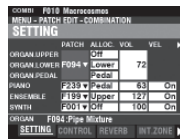

Press the [MENU/EXIT] button to enter MENU Mode and use the [DIRECTION] and [PAGE] buttons to locate the specific FUNCTION Mode you want.

② SET THE FAVORITE NUMBER TO LOAD THE PAGE

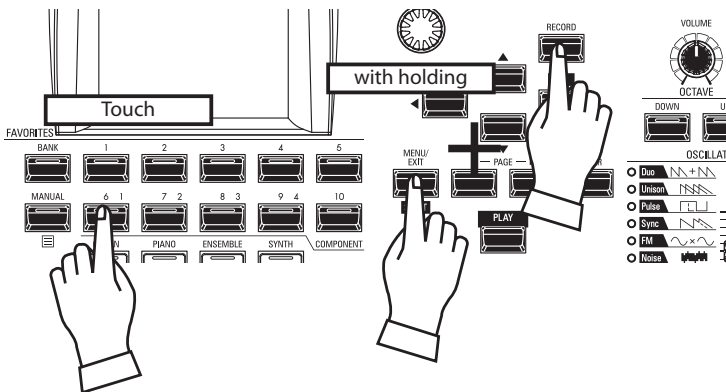

1. Touch and Hold the [SHIFT] and [RECORD] buttons together.
2. While holding the two buttons, touch any of the numbered [FAVORITE] buttons. The display will show, "Recording Assign" for approximately 1 second.

DISPLAY THE SAVED PAGE

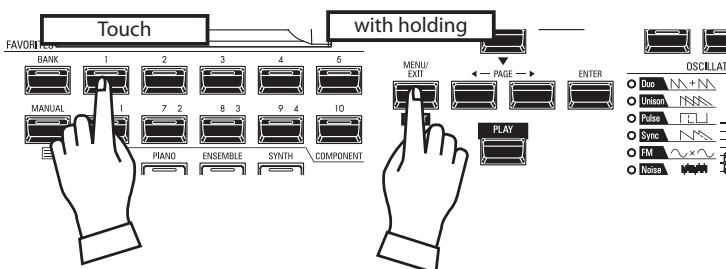

To display the saved Page, Press and Hold the [SHIFT] button and press the numbered [FAVORITE] button.

LOCKING THE DISPLAY

You can Lock the display in order to prevent accidental changes during live performance, or when more than one musician will be using the same instrument.

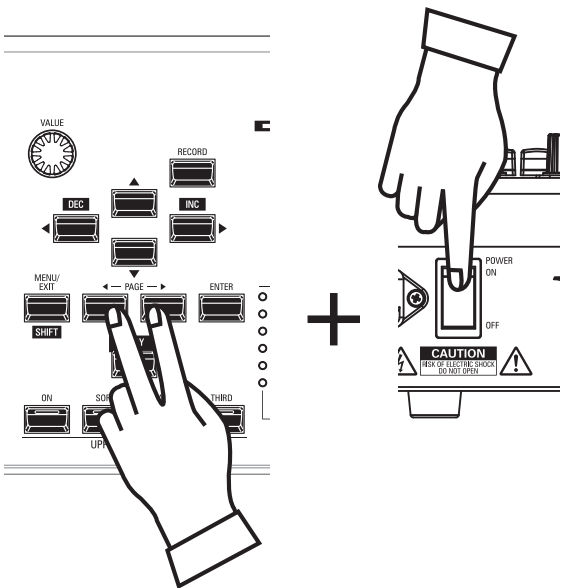

To Lock the display, do the following:

1. With the SK PRO power "OFF," Press and Hold the two PAGE [◀][▶] buttons.
2. While holding the PAGE buttons, turn the SK PRO power "ON." Continue to hold the PAGE buttons until "Confirming Display Locked/Unlocked" is shown in the display.

After approximately 5 seconds, "Display Locked" will show at the bottom of the display. You can then release the PAGE buttons.

To Unlock the display, follow the above two steps. You will see "Display Unlocked" in the display.

When the display is Locked:

1. [MENU/EXIT] is disabled.
2. [RECORD] is disabled.
3. The "Shortcut" feature is disabled.
4. Combinations and Patches can still be recalled.

NOTE: If the display is Locked, you will see a message in the display when the instrument is first turned "ON:" "Loading...Display Locked."

NOTE: If the display is Locked, holding the [RECORD] button and applying power will not Unlock it. Follow the procedure described above to Unlock the display.

Hammond maintains a policy of continuously improving and upgrading its instruments and therefore reserves the right to change specifications without notice. Although every attempt has been made to insure the accuracy of the descriptive contents of this Manual, total accuracy cannot be guaranteed.

Should the owner require further assistance, inquiries should first be made to your Authorized Hammond Dealer. If you still need further assistance, contact Hammond at the following addresses:

**In the United States Contact:
HAMMOND SUZUKI USA, Inc.**

219 West Wrightwood Ave. Elmhurst,
Illinois 60126
UNITED STATES
Tel: (630) 543-0277
Fax: (630) 543-0279

Web site: www.hammondorganco.com
E-mail: info@hammondorganco.com

Product Registration

[http://hammondorganco.com/support/
online-product-registration/](http://hammondorganco.com/support/online-product-registration/)



**In European countries contact:
HAMMOND SUZUKI EUROPE B. V.**

IR. D. S. Tuynmanweg 4a 4131 PN Vianen
THE NETHERLANDS
Tel: (+31) 347-370 594
Web site: www.hammond.eu
E-mail: info@hammond.eu

Product Registration

[http://www.hammond.eu/support/online-pro-
duct-registration/](http://www.hammond.eu/support/online-product-registration/)



**For other countries:
SUZUKI CORPORATION**

2-25-7, Ryoke, Naka-ku, Hamamatsu,
Shizuoka Pref. 430-0852
JAPAN
Tel: (+81) 53-460-3781
Fax: (+81) 53-460-3783
E-mail: suzukicorp@suzuki-music.co.jp

Technical materials are available and can be obtained by mailing a request to the appropriate address listed above marked ATTENTION: SERVICE DEPARTMENT.

Manufacturer:

SUZUKI MUSICAL INSTRUMENT MFG. Co., Ltd.
2-25-7, Ryoke, Naka-ku, Hamamatsu, Shizuoka Pref. 430-0852
JAPAN

