

# F3

## Field Recorder

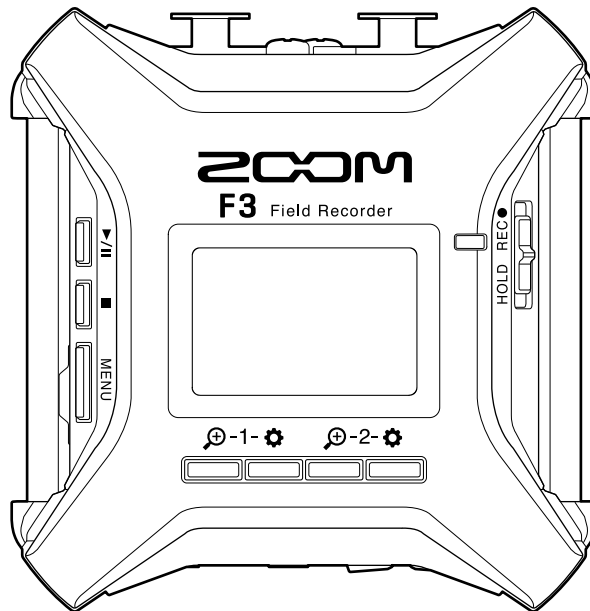

# Operation Manual

You must read the Usage and Safety Precautions before use.

©2022 ZOOM CORPORATION

Copying or reprinting this manual in part or in whole without permission is prohibited.

Product names, registered trademarks and company names in this document are the property of their respective companies. All trademarks and registered trademarks in this document are for identification purposes only and are not intended to infringe on the copyrights of their respective owners.

Proper display is not possible on grayscale devices.

# Notes about this Operation Manual

---

You might need this manual in the future. Always keep it in a place where you can access it easily. The contents of this document and the specifications of the product could be changed without notice.

- Windows® is a trademark or registered trademark of Microsoft® Corporation.
- Mac, macOS, iPadOS and App Store are registered trademarks of Apple Inc. in the USA and other countries.
- iOS is a trademark or registered trademark of Cisco Systems, Inc. in the USA and other countries, and it is used under license.
- Android and Google Play are trademarks of Google LLC.
- The microSD, microSDHC and microSDXC logos are trademarks.
- The Bluetooth® word mark and logo are registered trademarks of Bluetooth SIG, Inc., and these marks are used under license by Zoom Corporation. Other trademarks and trade names are the property of their respective companies.
- Recording from copyrighted sources, including CDs, records, tapes, live performances, video works and broadcasts, without permission of the copyright holder for any purpose other than personal use is prohibited by law. Zoom Corporation will not assume any responsibility related to infringements of copyrights.

# Contents

---

Notes about this Operation Manual.....	2
<b>F3 overview.....</b>	<b>5</b>
Achieving high audio quality throughout recording and editing.....	5
Functions of parts.....	9
Overview of screens that are shown.....	14
<b>Recording process.....</b>	<b>21</b>
<b>Making preparations.....</b>	<b>22</b>
Inserting microSD cards.....	22
Supplying power.....	23
Connecting input equipment.....	25
Turning the power on/off.....	27
Setting the display language (first time starting up).....	28
Setting the date and time (first time starting up).....	29
Preventing misoperation (hold function).....	30
<b>Making input settings.....</b>	<b>31</b>
Selecting inputs for making settings.....	31
Turning inputs on/off.....	32
Setting input sources.....	33
Changing phantom power voltage.....	35
Reducing noise (low-frequency cut).....	36
Inverting input phase.....	37
Applying delay to input signals.....	38
<b>Making output settings.....</b>	<b>39</b>
Setting alert sound output through headphones.....	39
Adjusting line output levels (playing test tones).....	41
Using the limiter on line output.....	43
Applying delay to line output.....	44
<b>Recording.....</b>	<b>45</b>
Waveforms shown when recording.....	45
Monitoring input/playback sounds.....	47
Making recording settings.....	48
Recording.....	56
<b>Playing recordings.....</b>	<b>57</b>
Playing recordings.....	57
Checking playback file information.....	59
Deleting recording files.....	60
<b>Managing files.....</b>	<b>61</b>
F3 folder and file structure.....	61
Selecting files for playback.....	62
Checking file information.....	63

Deleting files.....	64
Using as an audio interface.....	65
Connecting computers, smartphones and tablets.....	65
Making audio interface settings.....	68
Controlling the F3 from a smartphone/tablet.....	70
Disconnecting from a smartphone/tablet.....	71
Making various settings.....	72
Setting the type of batteries used.....	72
Setting the display backlight.....	74
Setting the display contrast.....	75
Setting the display language.....	76
Setting the date and time.....	77
Setting the date format.....	79
Setting the time until the power turns off automatically.....	81
When using timecode.....	83
Timecode overview.....	83
Connecting with an UltraSync BLUE.....	85
Checking timecode information.....	87
Setting the time shown on the Home/Recording Screen.....	89
Exchanging data with computers.....	91
Disconnecting a computer.....	92
Testing microSD cards.....	93
Conducting a quick test.....	93
Conducting a full test.....	95
Formatting microSD cards.....	97
Restoring factory default settings.....	98
Managing the firmware.....	99
Checking the firmware versions.....	99
Updating the firmware.....	99
Appendix.....	100
Troubleshooting.....	100
Block diagram.....	102
Specifications.....	103

# F3 overview

---

## Achieving high audio quality throughout recording and editing

With dual AD converter circuits and support for 32-bit float WAV files, the F3 can maintain the highest audio quality from recording to post-production.

### Recording

Dual AD converter circuits enable recording the loudest to the quietest sounds without adjusting gain.



## Post-production

Recording with 32-bit float WAV file formats allows the same audio quality to be retained when editing.



## Dual AD converter circuit overview

For each input circuit, the F3 has two AD converters with different input gains. This design enables high-quality audio recording without the need to adjust gain settings, a step that is normally indispensable.

### Providing amazing dynamic range

By combining two AD converters, a wide dynamic range not possible with a single AD converter has been realized.

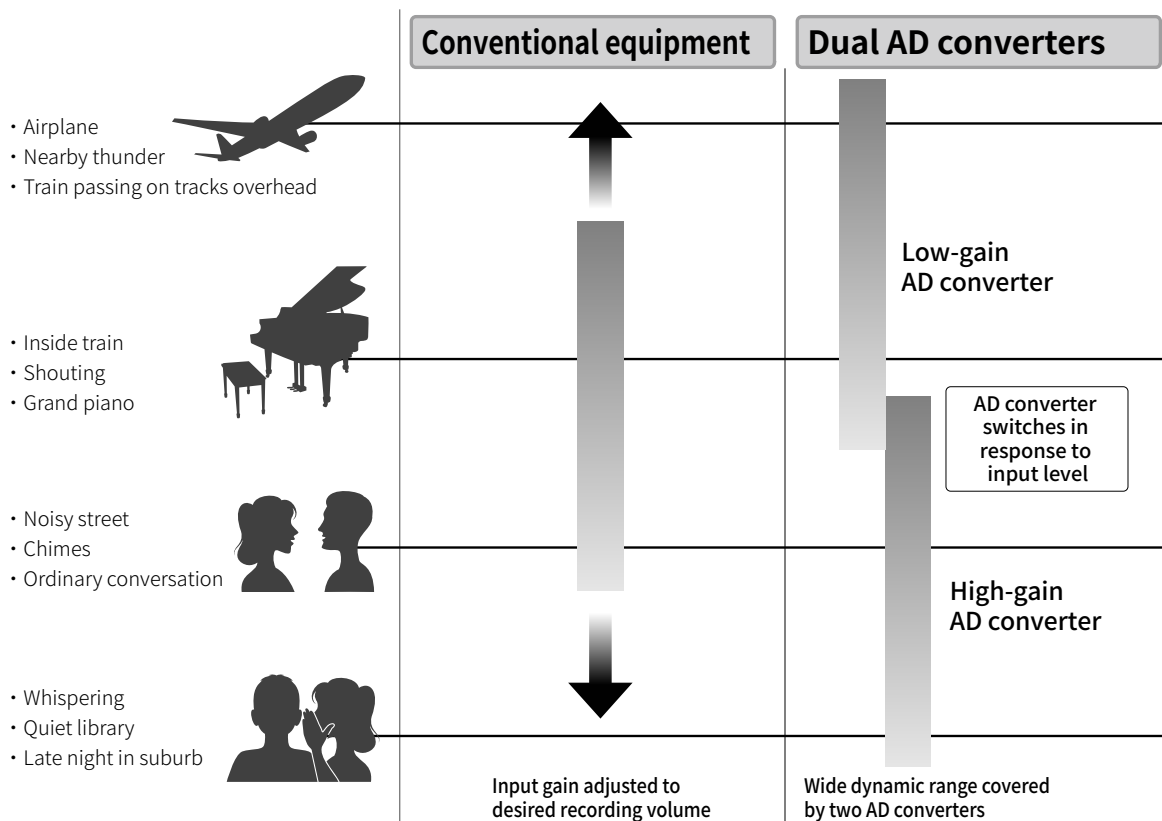

## Switching between two AD converters

The F3 constantly monitors data from the two AD converters, and automatically selects the one that provides the best recording results.

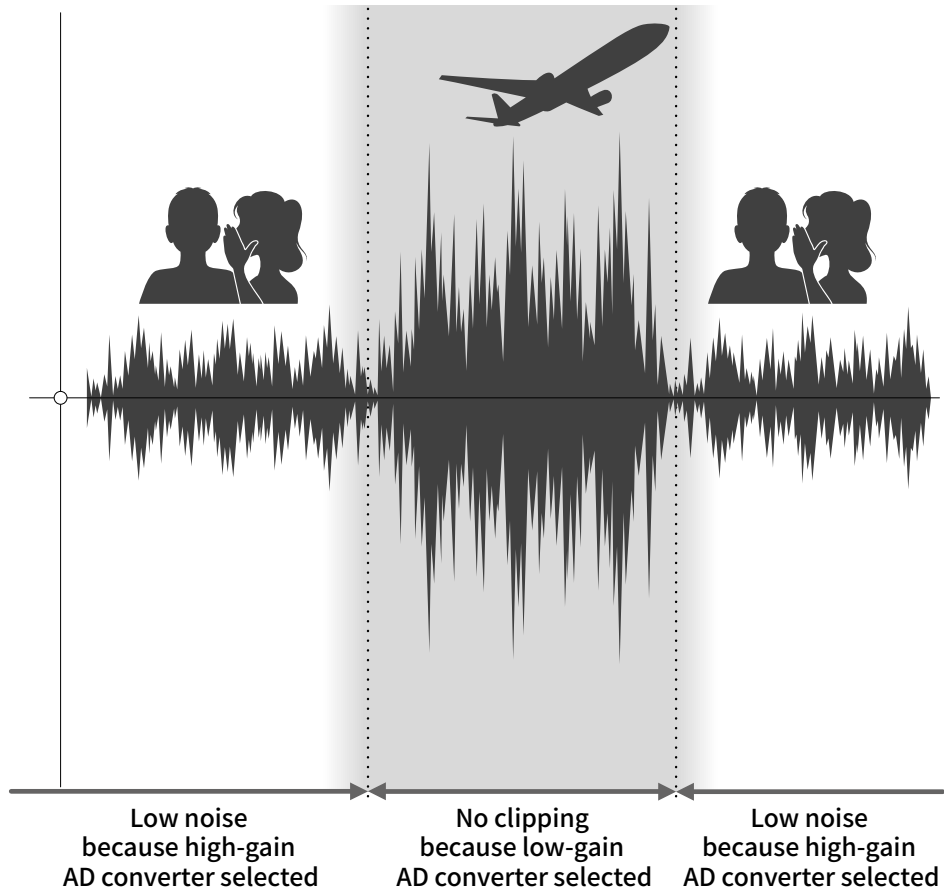

## 32-bit float WAV file overview

32-bit float WAV files have the following advantages over conventional 16/24-bit linear WAV files. These features enable the quality of the sound during recording to be maintained even during post-production.

### Resolution advantage

32-bit float WAV files have the advantage of being able to maintain high resolution even at low volumes. As a result, quiet sounds can be made louder when editing after recording without degrading their quality.

#### ■ 16/24-bit linear WAV

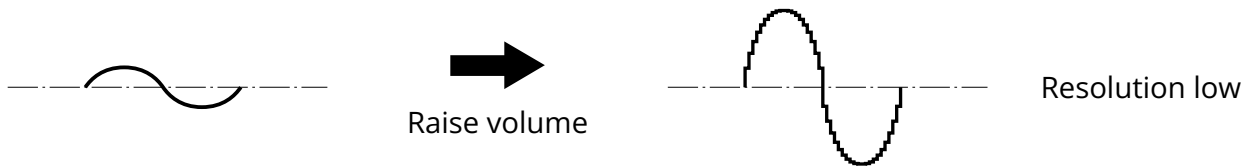

#### ■ 32-bit float WAV

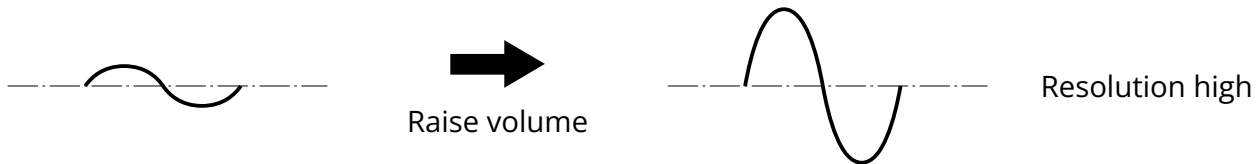

### Clipping advantage

If a waveform sounds clipped when output from the F3 or in a DAW, it can be edited after recording to lower its volume and restore an unclipped waveform because the data in the 32-bit float WAV file itself is not clipped.

#### ■ 16/24-bit linear WAV

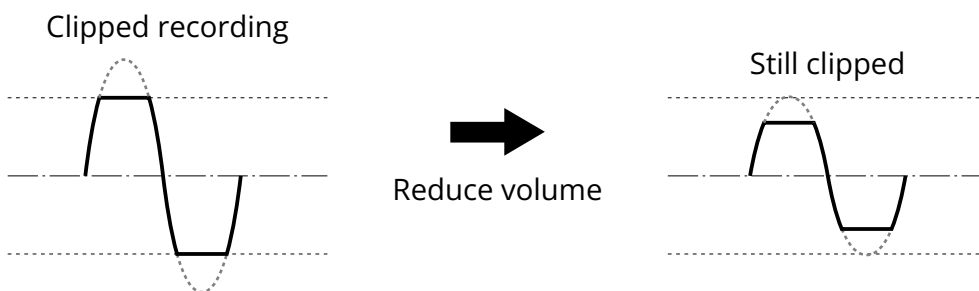

#### ■ 32-bit float WAV

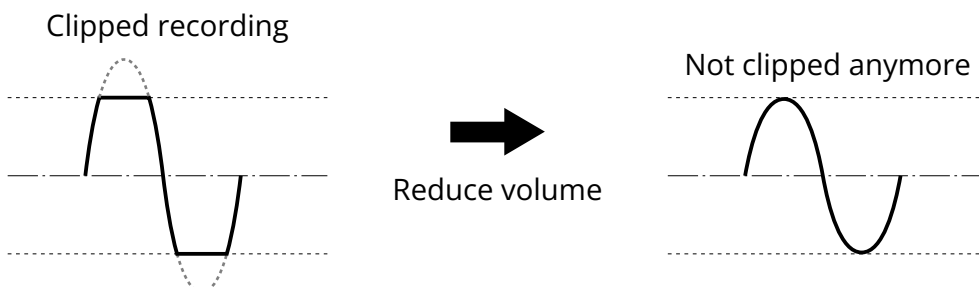



# Functions of parts

## Top and bottom

### ■ Top

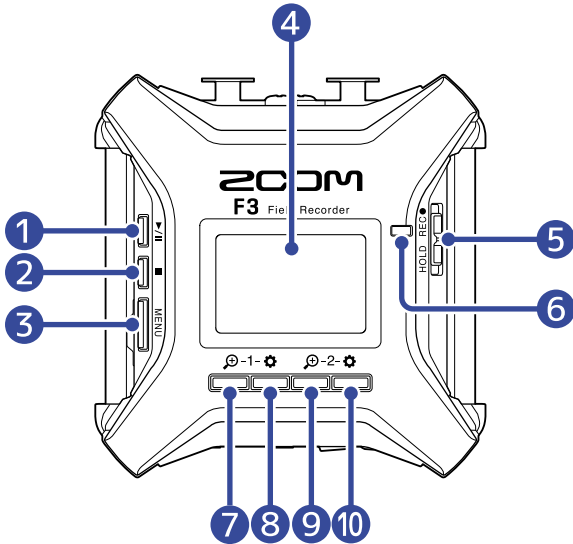

### ■ Bottom

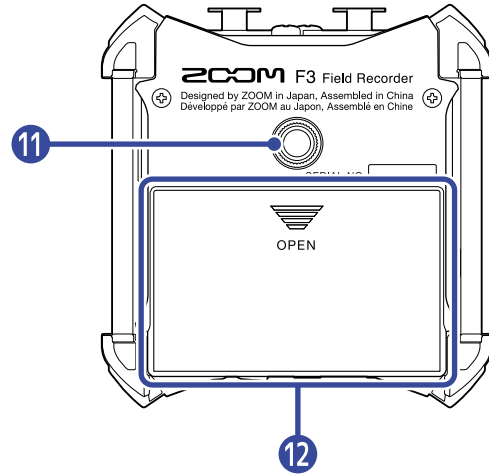

#### 1 PLAY button

This starts and pauses file playback.

#### 2 STOP button

This stops recording and playback.

#### 3 MENU button

This opens the Menu Screen and returns to the Home Screen.

#### 4 Display

This shows the recorder status and the Menu Screen.

#### 5 REC/HOLD switch

Use this to start recording and to disable button operation.

#### 6 REC LED

This lights during recording.

#### 7 1/operation button

When the Home Screen is open, this adjusts the amplification of the Input 1 waveform.

When other screens are open, this operates the function of the icon shown at the bottom of the screen. (→ [Operation button overview](#))

#### 8 1/operation button

When the Home Screen is open, this is used to make Input 1 settings.

When other screens are open, this operates the function of the icon shown at the bottom of the screen. (→ [Operation button overview](#))

**9**  **2/operation button**

When the Home Screen is open, this adjusts the amplification of the Input 2 waveform.

When other screens are open, this operates the function of the icon shown at the bottom of the screen. (→ [Operation button overview](#))

**10**  **2/operation button**

When the Home Screen is open, this is used to make Input 2 settings.

When other screens are open, this operates the function of the icon shown at the bottom of the screen. (→ [Operation button overview](#))

**11** **Tripod mounting threads**

This can be used to attach the F3 to a tripod, for example.

**12** **Battery compartment cover**

Open this when installing or removing AA batteries.

## ■ Operation button overview

When operation icons appear at the bottom of the display, including on the Menu, Playback and Input Settings screens, the corresponding operation buttons (immediately below the icons) can be used to select and confirm items on the screen.

### ■ Menu Screen example

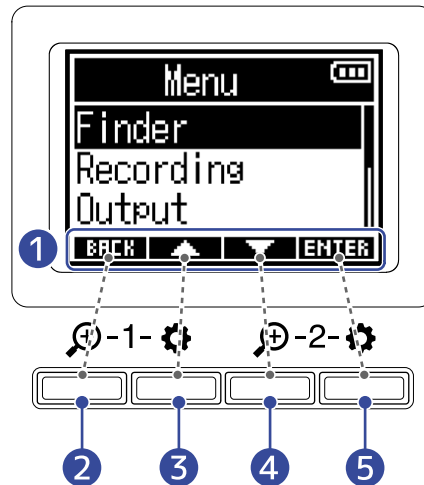

#### 1 Operation icons

The icons shown differ according to the screen.

#### 2 **BACK** operation button

This returns to the previous screen.

#### 3 operation button

This selects the item above.

#### 4 operation button

This selects the item below.

#### 5 **ENTER** operation button

This confirms the selected item.

Other operation icons will appear. Details about them are provided in the procedure explanations for various items.

### ■ Note about how procedures are written in this operation manual

In this operation manual, the use of operation buttons in procedures is indicated using icons in the following manner.

For example, "Use the operation buttons that correspond to  and  to select 'Finder' and press the operation button that corresponds to **ENTER** to confirm the selected item" is abbreviated as follows.

Use  /  to select "Finder", and press **ENTER** to confirm.

# Left and right sides

## ■ Left side

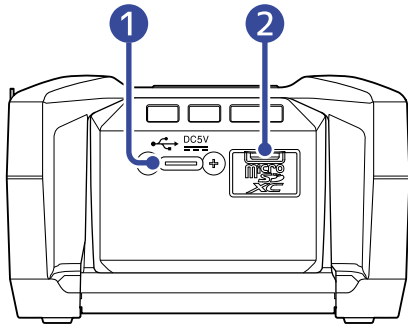

## ■ Right side

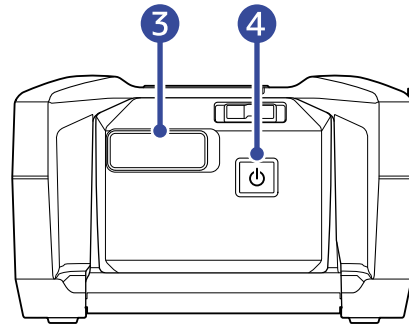

### 1 USB port (Type-C)

Connect this to a computer, smartphone or tablet to use the F3 as an SD card reader or audio interface. This supports operation on USB bus power.

### 2 microSD card slot

Insert a microSD card here.

### 3 REMOTE connector

Connect a ZOOM BTA-1 or other dedicated wireless adapter here.

This enables use of the F3 Control smartphone/tablet app to operate the F3 wirelessly.

Moreover, it also enables input of SMPTE timecode to the F3 using an UltraSync BLUE made by Timecode Systems.

### 4 POWER switch

This turns the power on/off.

# Front and back

## ■ Front

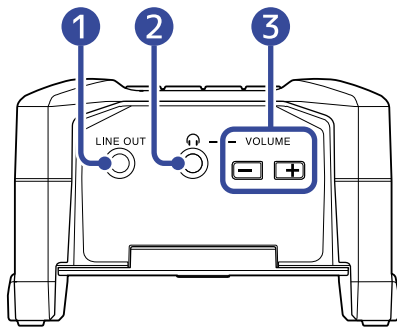

## ■ Back

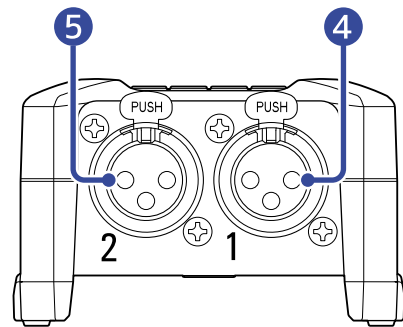

- 1** LINE OUT jack  
This stereo mini jack can be used to output sound.
- 2** PHONE OUT jack  
This can output sound to headphones.
- 3** VOLUME buttons  
Use these to adjust the headphone volume.
- 4** Input 1  
Connect a mic here. This can be used with XLR plugs.
- 5** Input 2  
Connect a mic here. This can be used with XLR plugs.

# Overview of screens that are shown

This section explains the screens shown on the F3 display.

## Home Screen

This appears on the display when the F3 power is turned on. This shows the recording state, input signal waveforms and other F3 conditions.

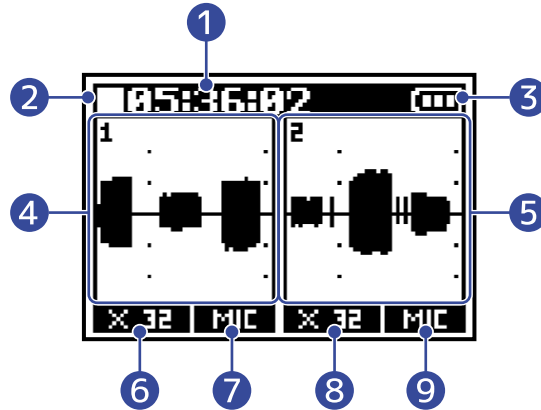

### 1 Counter

This shows the available recording time when in recording standby and the current elapsed recording time when recording. The remaining available recording time can also be shown when recording. (→ [Setting the recording time display](#))

### 2 Status icon

This icon shows the recording status.

- Stopped
- Recording

### 3 Remaining battery charge indicator

When the remaining battery charge becomes low, change the batteries (→ [Installing batteries](#)) or connect an AC adapter (→ [Connecting an AC adapter](#)) or a mobile battery (→ [Using other power sources](#)).

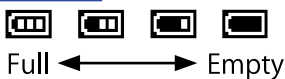

### 4 Waveform display (Input 1)

This shows the waveform of the signal input through Input 1. (→ [Waveforms shown when recording](#))

### 5 Waveform display (Input 2)

This shows the waveform of the signal input through Input 2. (→ [Waveforms shown when recording](#))

### 6 Waveform magnification (Input 1)

This shows the magnification of the Input 1 waveform display. (→ [Waveforms shown when recording](#))

### 7 Input source (Input 1)

This shows the input source currently set for Input 1. (→ [Setting input sources](#))

8 **Waveform magnification (Input 2)**

This shows the magnification of the Input 2 waveform display. (→ [Waveforms shown when recording](#))

9 **Input source (Input 2)**

This shows the input source currently set for Input 2. (→ [Setting input sources](#))

---

**HINT:**

When the Home Screen is not shown, press  to return to the Home Screen. This is convenient for opening the Home Screen quickly from various settings screens. (Moving directly to the Home Screen from some screens is not possible.)

---

# Playback Screen

This screen is shown on the display during playback. This shows the elapsed time, output signal waveforms and other F3 playback states.

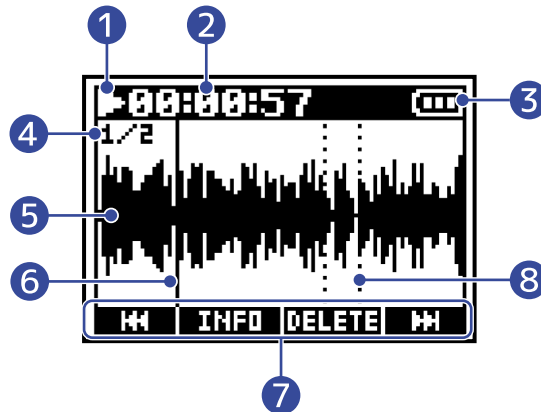

## 1 Status icon

This icon shows the playback status.

- Playing back
- Paused
- Searching backward
- Searching forward

## 2 Counter

This shows the elapsed playback time.

## 3 Remaining battery charge indicator

When the remaining battery charge becomes low, change the batteries (→ [Installing batteries](#)) or connect an AC adapter (→ [Connecting an AC adapter](#)) or a mobile battery (→ [Using other power sources](#)).

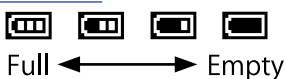

## 4 File format

This changes according to the format of the file playing back. (→ [Selecting the recording file format \(Mono/Stereo\)](#))

- 1/2: File with recording of both Inputs 1 and 2 when "Recording" > "File Format" set to "Mono"
- 1: File with recording of either Input 1 or 2 when "Recording" > "File Format" set to "Mono"
- L/R: File with recording when "Recording" > "File Format" set to "Stereo"

## 5 Waveform display

This shows the waveform of the recording file that is playing back.

## 6 Playback position bar

This shows the current playback position.



## 7 Operation icons

Search forward/backward, delete files and view information by pressing the operation buttons below the display that correspond to these icons. (→ [Operation button overview](#))

## 8 Marker bar

This shows where a mark has been added to the playback file.

### **NOTE:**

Marks can only be added by using the dedicated app on a smartphone or tablet. A BTA-1 or other dedicated wireless adapter is necessary to use the app on the smartphone/tablet for control. See the F3 Control operation manual for detailed explanations about marks.

# Menu Screen

Use the Menu Screen to make various settings, including recording, output and system settings.



## 1 Menu title

## 2 Menu items

These show setting items and values and other information.

## 3 Operation icons

Press the operation buttons below the display that correspond to these icons to select menu items and confirm selected items. (→ [Operation button overview](#))

## 4 Remaining battery charge indicator

When the remaining battery charge becomes low, change the batteries (→ [Installing batteries](#)) or connect an AC adapter (→ [Connecting an AC adapter](#)) or a mobile battery (→ [Using other power sources](#)).

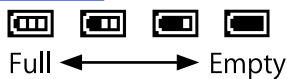

## 5 Scrollbar

This will appear when there are more items than will fit on the display.

## ■ Opening the Menu Screen

1. Press  when the Home Screen is open.

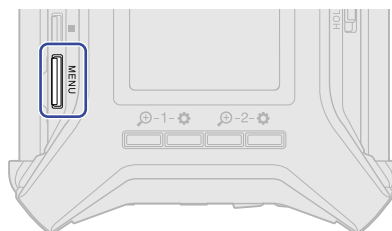



### HINT:

When the Home Screen is not shown, press  to return to the Home Screen. This is convenient for opening the Home Screen quickly from various settings screens. (Moving directly to the Home Screen from some screens is not possible.)

# Character input screen

A character input screen will appear for inputting the User Defined Name used for the Rec File Name setting.

Use the operation buttons below the display to input characters.

1. Use  and  to move the cursor (|), and press  to input the selected character or execute the selected function.

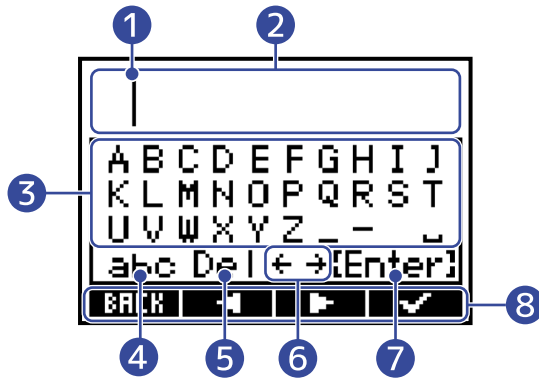

**1** Character input position

The character will be input at this position.

**2** Character input area

This shows the input characters.

**3** Character selection area

Select characters to input here.

**4** Change character type

This changes the characters that can be selected in the character selection area.

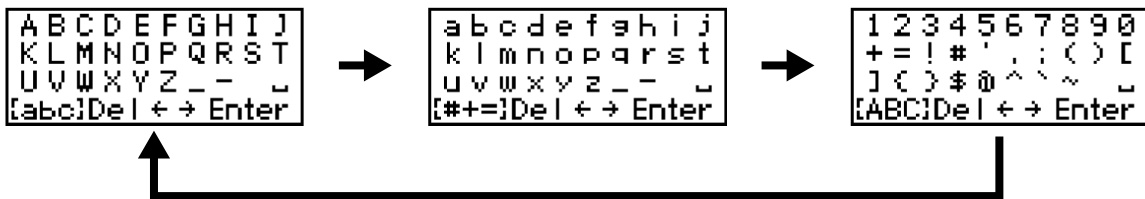



**5** Delete character

**6** Move character input position

**7** Confirm input text

**8** Operation icons

Press the operation buttons below the display that correspond to these icons to input characters and execute selected functions.

2. Repeat step 1 to input more characters. When done inputting, use  /  to select "Enter" and use  to confirm.

**NOTE:**

The characters and symbols that can be used are as follows.

! # \$ ' ( ) + , - ; = @ [ ] ^ \_ ` { } ~ (space) A-Z, a-z, 0-9

# Recording process



---

Recording follows the process shown below.



## Preparation before recording

- Insert a microSD card (→ [Inserting microSD cards](#))
- Supply power (→ [Installing batteries](#)/→ [Connecting an AC adapter](#))
- Connect mics/other equipment to inputs (→ [Connecting input equipment](#))
- Turn the power on (→ [Turning the power on](#))
- Make settings related to input (→ [Making input settings](#))
- Make settings related to recording (→ [Making recording settings](#))

## Recording

- Use  to start recording and press  to stop (→ [Recording](#))

## Playing back and reviewing

- Press  to start playback and press  to stop (→ [Playing recordings](#))

# Making preparations

## Inserting microSD cards

1. When the power is off, open the microSD card slot cover, and insert a microSD card all the way into the slot.

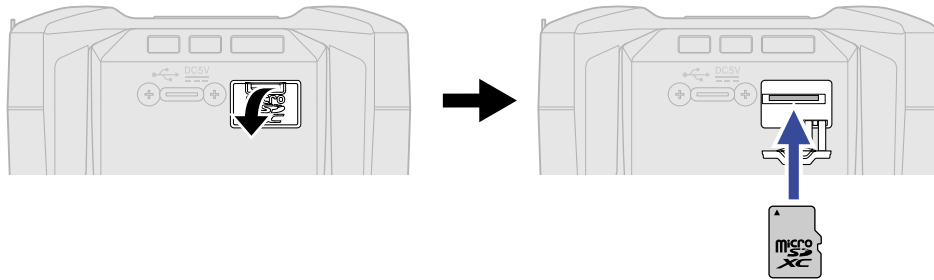

To remove a microSD card, push it further into the slot and then pull it out.

2. Close the microSD slot cover.

### NOTE:

- Always make certain that the power is off when inserting or removing a microSD card. Inserting or removing a card while the power is on could result in data loss.
- When inserting a microSD card, be sure to insert the correct end with the top side up.
- Recording and playback are not possible when a microSD card is not loaded in the F3.
- After purchasing a new microSD card, always format it using the F3 to maximize performance. (→ [Formatting microSD cards](#))

## Supplying power

The F3 can operate using either a power supply connected to its USB port (AC adapter, USB bus power or mobile battery) or batteries.

A power supply connected to the USB port will be given priority over batteries.

## Installing batteries

To run the F3 using batteries, install 2 AA batteries in the battery compartment. Open the cover on the bottom by sliding it while pressing  OPEN.

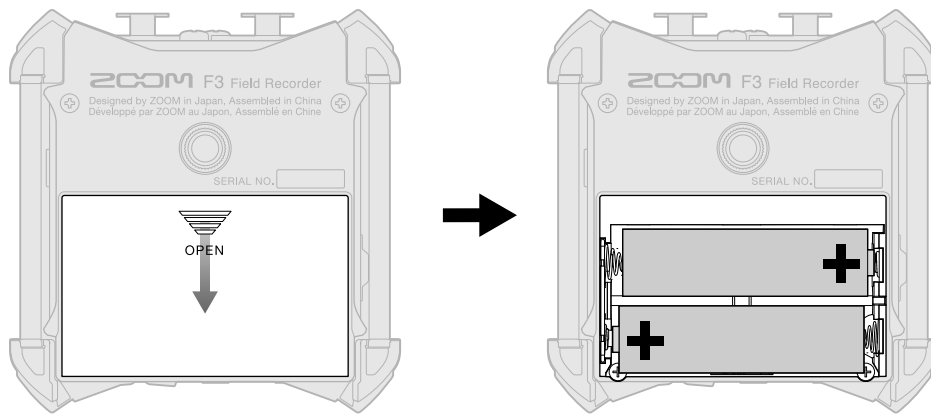

### NOTE:

- Use only one type of battery (alkaline, NiMH or lithium) at a time.
- Set the type of battery used correctly so that the amount of remaining battery charge can be shown accurately. (→ [Setting the type of batteries used](#))
- If the battery charge becomes low, turn the power off immediately and install new batteries. The remaining battery charge is always shown (on most screens) when operating on battery power.

## Connecting an AC adapter

---

Connect the cable of the dedicated AC adapter (AD-17) to the Type-C USB port, and connect the AC adapter to an outlet.

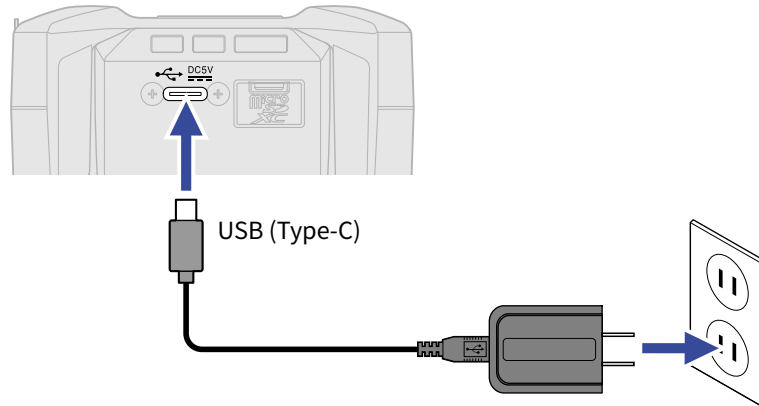

## Using other power sources

---

The F3 can be powered by USB bus power by connecting its Type-C USB port to a computer. A 5V mobile battery (commercially-available) can also be used to provide power.

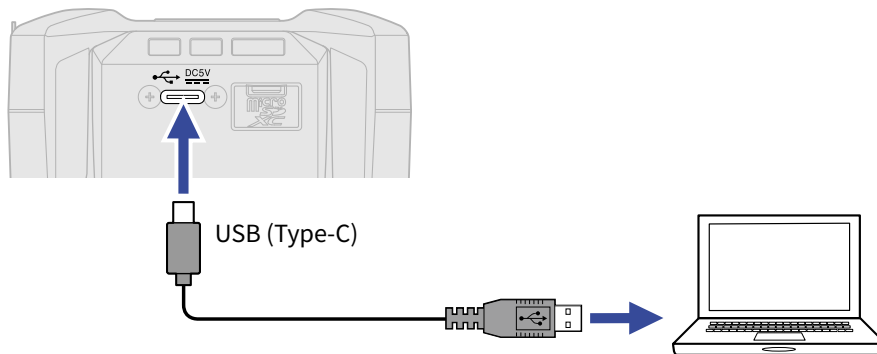



# Connecting input equipment

## Connecting mics and other equipment to Inputs 1 and 2

The F3 has 2 inputs (1 and 2) that can be used to record to corresponding tracks. Mics and other equipment can be connected to Inputs 1 and 2 and recorded to corresponding tracks.

### ■ Connecting mics

Connect dynamic and condenser mics with XLR plugs to Inputs 1 and 2.

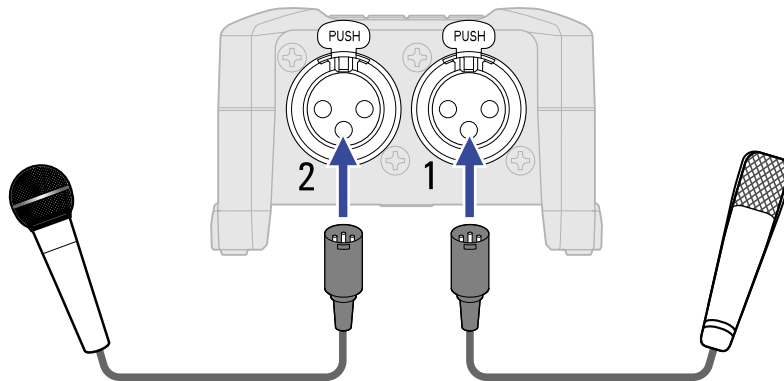

- When connecting mics, set the Input Source to Mic. (→ [Setting input sources](#))
- Phantom power (+24 V/+48 V) can be supplied to condenser mics. (→ [Setting input sources](#))

### ■ Connecting line level equipment

Mixers and other line level equipment can be connected using cables with XLR plugs.

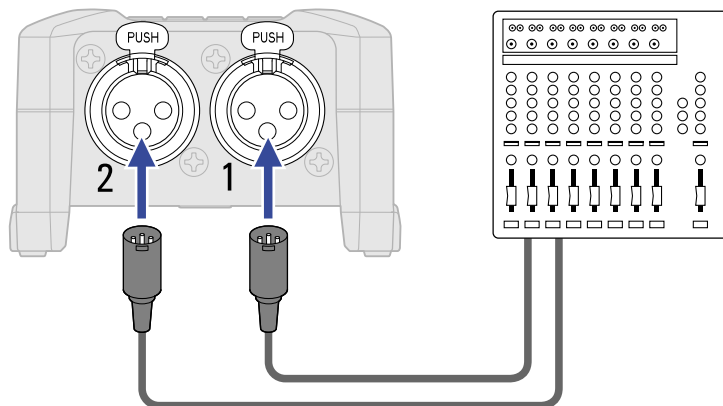

- When connecting line level equipment, set the Input Source to Line. (→ [Setting input sources](#))
- Direct input of passive guitars and basses is not supported. Connect these instruments through a mixer or effects device.

## Connection examples

Recording is possible in the following kinds of situations.

### ■ While filming

Wireless lavalier mics can be used to record sound during video recording.

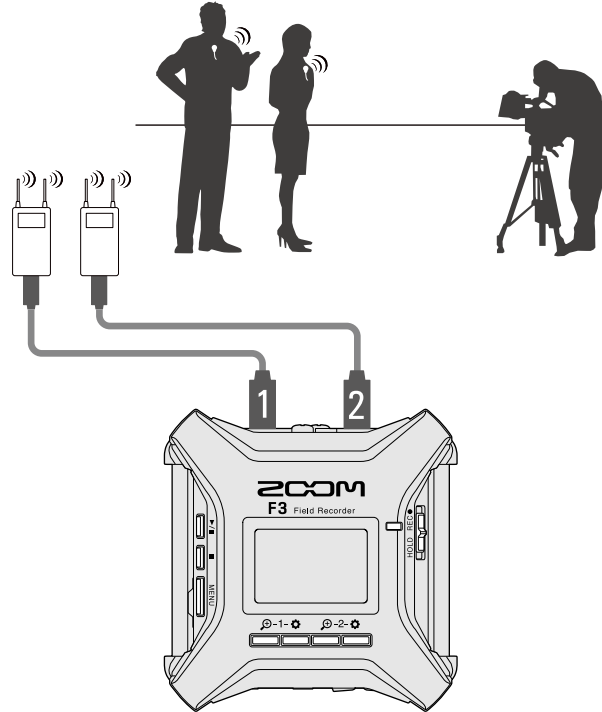

### ■ Concert recording

Two mics can be used to record sound in stereo.

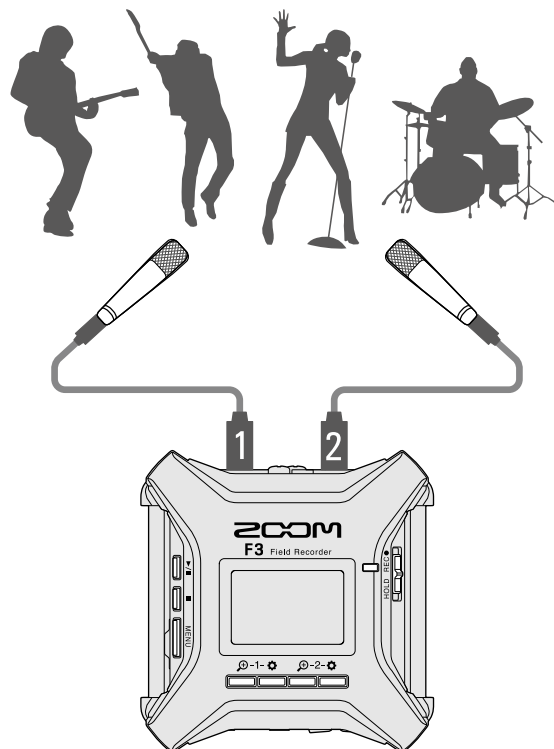

# Turning the power on/off

## Turning the power on

1. Press and hold .

Confirm that  has not been set to "HOLD". If it is shifted to "HOLD", the F3 power cannot be turned on. (→ [Preventing misoperation \(hold function\)](#))

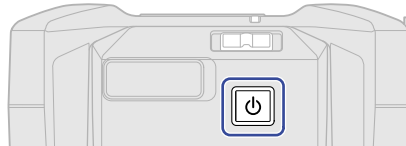

This turns the F3 power on and opens the Home Screen (→ [Home Screen](#)) on the display.

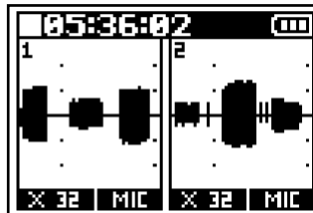

The first time the power is turned on after purchase, as well as after the F3 has been restored to its factory default settings, screens to set the display language and the date and time will appear. Make these settings. (→ [Setting the display language \(first time starting up\)](#), [Setting the date and time \(first time starting up\)](#))

### NOTE:

- The F3 can be set to automatically turn its power off if it is not used for a set amount of time. (→ [Setting the time until the power turns off automatically](#))
- If "No SD Card!" appears on the display, confirm that a microSD card is inserted properly. (→ [Inserting microSD cards](#))
- If "Invalid SD Card!" appears on the display, the card is not formatted correctly. Format the microSD card or use a different microSD card. (→ [Formatting microSD cards](#), [Inserting microSD cards](#))

## Turning the power off

1. Press  until "Goodbye! See You!" appears on the display.



The display becomes blank and the power turns off.

### NOTE:

When the power is turned off, the current mixer settings are saved on the F3.

## Setting the display language (first time starting up)

The first time the power is turned on after purchase, set the display language when the Language Screen opens.

1. Use  /  to select the display language and press  to confirm.



After confirming the language used on the display, set the date and time when the Set Date/Time screen opens. (→ [Setting the date and time \(first time starting up\)](#))

---



**HINT:**

The display language setting can also be changed later from the Menu Screen. (→ [Setting the display language](#))



---

## Setting the date and time (first time starting up)

The first time the power is turned on after purchase, after setting the display language, set the date and time when the Set Date/Time Screen opens. The date and time are added to recording files.

1. Use  and  to select the item to set and press  to confirm.



2. Use  and  to change the value and press  to confirm.

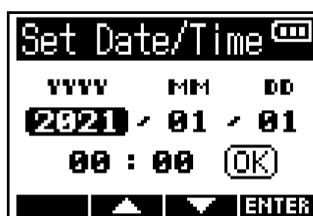

3. Repeat steps 1-2 to set the date and time.

4. After setting all items, use  and  to select , and press  to confirm.

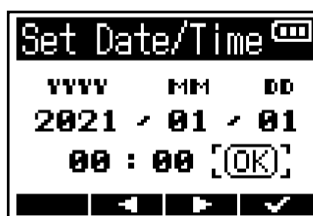

### NOTE:

If power is not supplied for a long time, the date and time data stored in the unit will be reset. If the Set Date/Time Screen appears during startup, set them again.

### HINT:

The date and time setting can also be changed later from the Menu Screen. (→ [Setting the date and time](#))

# Preventing misoperation (hold function)

In order to prevent misoperation, the hold function can be used to disable the buttons on the F3.

**1.** Slide  to HOLD.

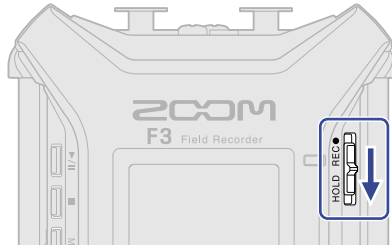

If the HOLD function is on, all operations using buttons will be disabled.



To deactivate the hold function, slide  back to the center position.

---

## HINT:

- When  is shifted to "HOLD", the F3 power cannot be turned on. This is useful to prevent the F3 power from being turned on accidentally.
  - When disabling the hold function, recording will not start or stop even if  is shifted to "REC".
-



# Making input settings

## Selecting inputs for making settings

Input settings can be made for each input separately. Select the input desired for making input settings.

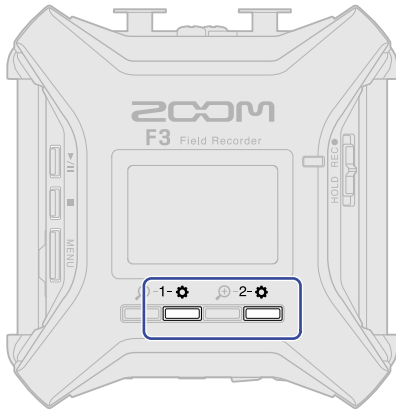
1. Press  for the input desired for making settings.



- : Open the settings screen for Input 1.
- : Open the settings screen for Input 2.

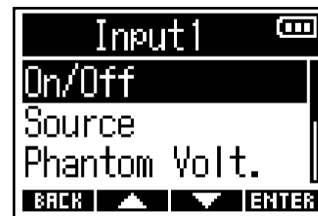

### NOTE:

On each Input Settings Screen, only sound from that input can be monitored (only the signal output from the PHONE OUT jack).

The following parameters can be set for each input.



Item	Explanation
On/Off	This turns the input on or off. (→ <a href="#">Turning inputs on/off</a> )
Source	This sets the input source and phantom power on/off status of the track. (→ <a href="#">Setting input sources</a> )
Phantom Volt.	The voltage of the phantom power can be changed. (→ <a href="#">Changing phantom power voltage</a> )
HPF	The high pass filter can cut low frequencies to reduce the sound of wind, vocal pops and other noise. (→ <a href="#">Reducing noise (low-frequency cut)</a> )
Invert Phase	The phase of input signals can be inverted. This is useful when sounds cancel each other out due to mic settings. (→ <a href="#">Inverting input phase</a> )
Delay	If there are differences in the timing of input sounds, use this function to correct them when recording. (→ <a href="#">Applying delay to input signals</a> )

# Turning inputs on/off



Each input can be turned on/off.

Turning unused inputs off can increase the length of continuous operation using batteries. The amount of microSD card use can also be reduced.

1. Press  for the input to set. (→ [Selecting inputs for making settings](#))  
This opens the Input Settings Screen.

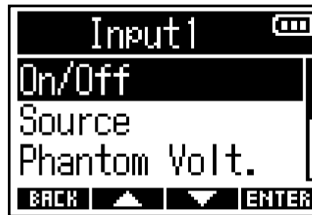
2. Use  /  to select "On/Off" and press **ENTER** to confirm.



3. Use  /  to select "On" or "Off" and press  to confirm.



Waveforms for inputs that are set to "Off" will stop being shown on the Home Screen.

Example: Input 2 set to "Off"

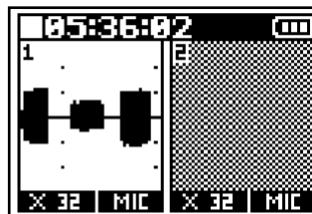

## NOTE:



If the File Format setting is "Stereo" (→ [Selecting the recording file format \(Mono/Stereo\)](#)), the Input "On/Off" setting will be the same for both Inputs 1 and 2.







# Setting input sources

The input source and phantom power on/off status can be set for each track.

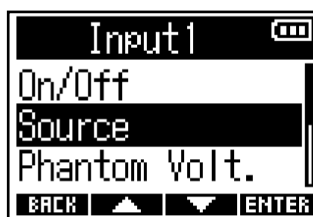
1. Press  for the input to set. (→ [Selecting inputs for making settings](#))  
This opens the Input Settings Screen.

2. Use  /  to select "Source" and press **ENTER** to confirm.



3. Use  /  to select the source and press  to confirm.



Item	Explanation
Mic	Use when connecting a mic or other equipment with a low input level.
Mic (+48V)	Use when connecting equipment with mic level input that requires phantom power.
Line	Use when connecting line level equipment. The input level will be reduced 20 dB compared to when "Mic" or "Mic (+48V)" is selected.
Line (+48V)	Use when connecting equipment with line level input that requires phantom power.

## NOTE:

- When connecting equipment that is not compatible with phantom power, do not set this to "Mic (+48V)" or "Line (+48V)". Doing so could damage the equipment.
- Item names will change to reflect the "Phantom Volt." Setting. (→ [Changing phantom power voltage](#))

---

**HINT:**

- The phantom power voltage can be changed. (→ [Changing phantom power voltage](#))
- When using only Input 1 or Input 2, making the following settings can increase battery operation time and reduce microSD card use.

Turn off the input not being used. (→ [Turning inputs on/off](#))

Set the Recording File Format to Mono. (→ [Selecting the recording file format \(Mono/Stereo\)](#))

---



## Changing phantom power voltage

The phantom power voltage can be changed by selecting +24V or +48V. The selected voltage setting will be applied to both Input 1 and Input 2.

1. Press  for Input 1 or Input 2. (→ [Selecting inputs for making settings](#))  
This opens the Input Settings Screen.

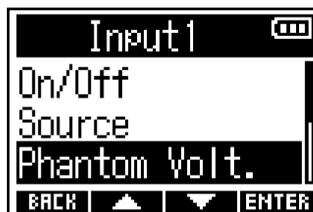
2. Use  /  to select "Phantom Volt." and press **ENTER** to confirm.



3. Use  /  to select the voltage and press  to confirm.

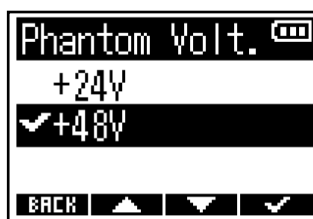

---



### HINT:

- Phantom power is a function that supplies power to equipment that uses an external power supply, including some condenser mics. The standard power is +48V, but some equipment can operate with lower voltages.
  - By setting the phantom power voltage to +24V when using mics that can operate on this voltage, continuous battery operation time can be lengthened.
-



## Reducing noise (low-frequency cut)

Low frequencies can be cut to reduce the sound of wind, vocal pops and other noise.

1. Press  for the input to set. (→ [Selecting inputs for making settings](#))  
This opens the Input Settings Screen.

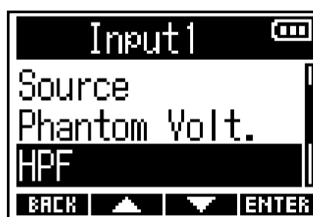
2. Use  /  to select "HPF" and press **ENTER** to confirm.



3. Use  and  to select the cut-off frequency, and press  to confirm.



---

**HINT:**

This can be set to "Off" or in a range of 10–240 Hz.

---

## Inverting input phase



The phase of input signals can be inverted.

If sounds are canceling each other due to mic settings, inverting the phase might prevent this phenomenon.

1. Press  for the input to set. (→ [Selecting inputs for making settings](#))  
This opens the Input Settings Screen.

2. Use  /  to select "Invert Phase" and press **ENTER** to confirm.



3. Use  /  to select "On" and press  to confirm.

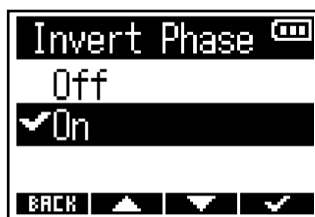

# Applying delay to input signals

If there are differences in the timing of input signal sounds, use this function to correct them when recording.

1. Press  for the input to set. (→ [Selecting inputs for making settings](#))  
This opens the Input Settings Screen.

2. Use  /  to select "Delay" and press **ENTER** to confirm.

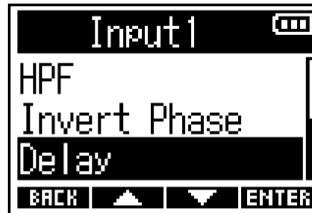

3. Use  /  to set the delay time and press  to confirm.



**NOTE:**

If the sample rate is 192 kHz, delay will be disabled. (→ [Setting the sample rate](#))

**HINT:**

This can be set from 0.0 ms to 30.0 ms.



# Making output settings

## Setting alert sound output through headphones

The volume can be adjusted for the alert sounds output from headphones when, for example, recording starts and stops.

1. Press .

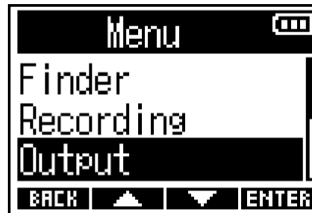

This opens the Menu Screen.

2. Use  /  to select "Output" and press  to confirm.

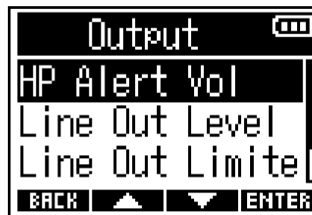

3. Use  /  to select "HP Alert Vol" and press  to confirm.



4. Use  /  to adjust the volume and press  to confirm.



### HINT:

- This can be set to "Off" or set from -48 to -12 dBFS.
- When set to "Off", no alerts will be output.

## ■ Alert sound conditions and types

Alert sound condition	Sound type
Remaining battery low	880 Hz tone 4 times
Recording starting	1000 Hz tone 1 time
Recording stopping	880 Hz tone 2 times
Recording not possible	880 Hz tone 3 times



# Adjusting line output levels (playing test tones)

The line output levels to connected equipment can be adjusted.

Test tones can be played in order to adjust the levels for a digital SLR camera or other equipment.

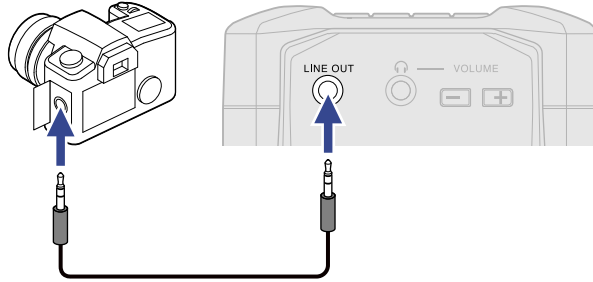

1. Minimize the input gain of the other equipment.
2. Use an audio cable to connect the external mic jack of the other equipment with the F3 LINE OUT jack.



## NOTE:

When output to a digital SLR camera or other equipment is not necessary, do not connect anything to the LINE OUT jack.

When nothing is connected to the LINE OUT jack, the line output function is automatically disabled, which could lengthen continuous battery operation time.



3. Use  /  to select "Output" and press **ENTER** to confirm.

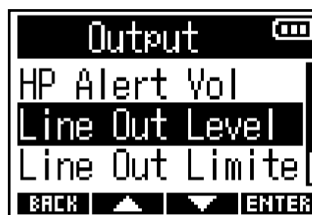

4. Use  /  to select "Line Out Level" and press **ENTER** to confirm.



To output a test tone from the F3 to adjust the output level, skip to step 6.

5. Use  /  to adjust the line output level and press  to confirm.

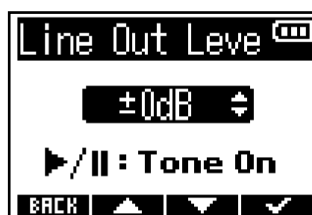

---

**HINT:**

- This can be set to "Mute" or from -48 dB to +24 dB.
  - When "Mute" is selected, output from the LINE OUT jack is muted.
- 

**6.** To output a test tone from the F3 to adjust the output level, press .

While checking the audio level meter of the connected equipment, make adjustments to the input gain of that device until the audio signal level is about -6 dB.

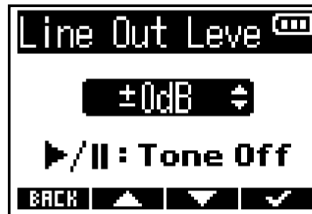

---

**HINT:**

The test tone is a 1kHz sine wave at -6 dBFS.

---

**7.** After adjusting the input gain of the connected equipment, press .

This stops test tone output.

**NOTE:**



- See the manual of the connected device for information about its operation.
- If the automatic gain control function on the other device is on, turn it off.
- The test tone is output from both the LINE OUT and PHONE OUT jacks.
- Be careful with the volume if you are monitoring the sound with headphones, for example.

# Using the limiter on line output



By using the limiter on the line output, signals with levels that are too high can be suppressed, protecting equipment connected to the line output jack.

1. Press .

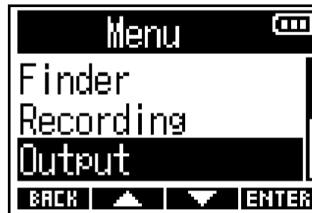

This opens the Menu Screen.

2. Use  /  to select "Output" and press  to confirm.

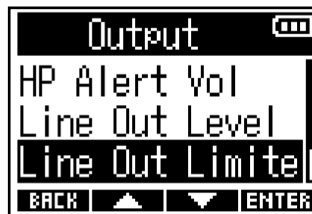

3. Use  /  to select "Line Out Limiter" and press  to confirm.



4. Use  /  to select "On" and press  to confirm.

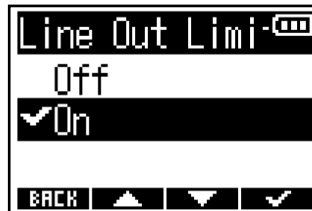



# Applying delay to line output



By delaying line output, timing differences for audio input into other equipment can be corrected.

1. Press .

This opens the Menu Screen.

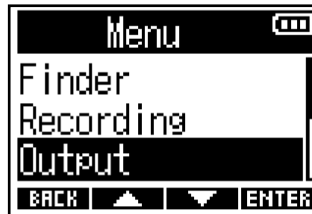
2. Use  /  to select "Output" and press **ENTER** to confirm.



3. Use  /  to select "Line Out Delay" and press **ENTER** to confirm.

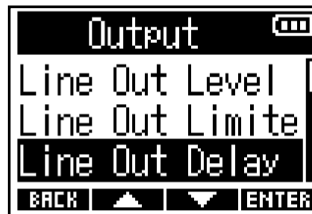

4. Use  /  to set the delay time and press  to confirm.



## NOTE:

Line out delay is disabled when the sample rate is 192 kHz. (→ [Setting the sample rate](#))

## HINT:

This can be set from 0 ms to 400 ms.

# Recording

## Waveforms shown when recording



The F3 records in 32-bit float format, so the input gain does not need to be adjusted. Depending on the input signals, however, waveforms shown on the display could appear too small or too large, making them difficult to check.

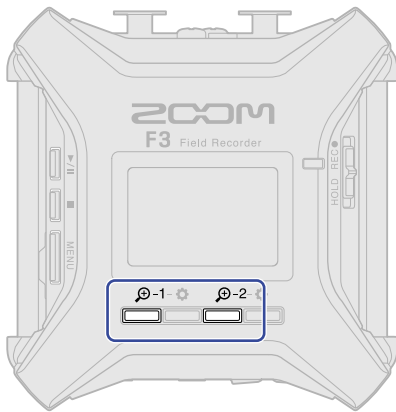

By changing the waveform display magnification, input waveforms can be adjusted to sizes that are easy to check. The magnification rate can be set separately for each input.

The volume will also be changed according to the waveform magnification rate.

1. Press  for the input desired for making settings.



-  : Use this to set Input 1.
-  : Use this to set Input 2.

Icons to decrease/increase (  /  ) the magnification for that input will appear.

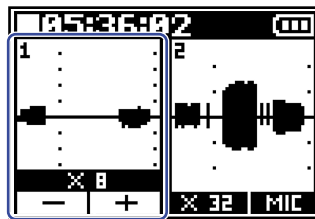

2. Use  **-**  and  **+**  to adjust the input signal waveform to a size that is easy to check.

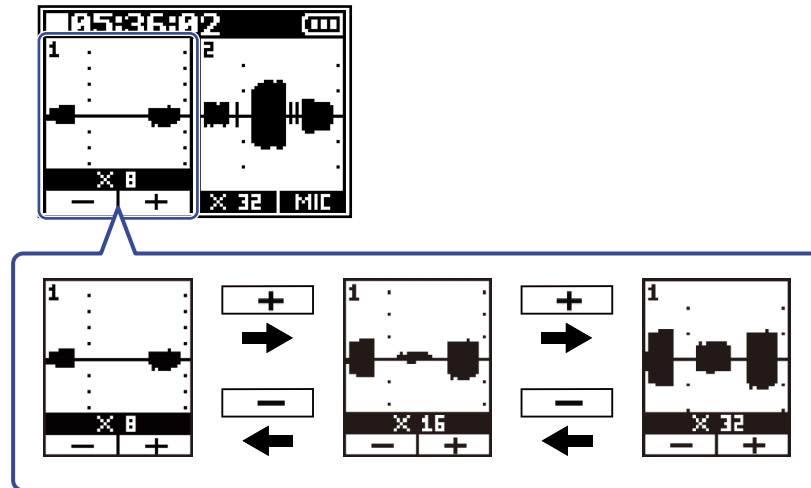

The magnification rate (   **$\times 32$**   ) is shown above  **-**  and  **+**  .

**NOTE:**



- The magnification rate can be set in 11 steps:  $\times 1$  ,  $\times 2$ ,  $\times 4$ ,  $\times 8$ ,  $\times 16$ ,  $\times 32$ ,  $\times 64$ ,  $\times 128$ ,  $\times 256$ ,  $\times 512$  and  $\times 1024$ .
- Be careful with the volume if you are monitoring the input sound with headphones, for example.
- Changing the magnification rate, even in the middle of recording, will not affect the recording level.

# Monitoring input/playback sounds

Input/playback sounds can be monitored using headphones, for example, and the volume can be adjusted.

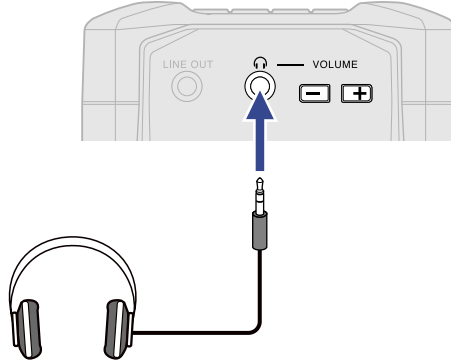
1. Connect headphones, for example, to the PHONE OUT jack.



2. Use   to adjust the volume to the headphones or other equipment.

The volume is shown on the display while it is being adjusted.



## NOTE:

When monitoring with headphones or other equipment is not necessary, do not connect anything to the PHONE OUT jack. When nothing is connected to the PHONE OUT jack, the headphone monitoring function is automatically disabled, which could lengthen continuous battery operation time.

## HINT:

The volume output from the PHONE OUT jack is also affected by changing the waveform display magnification. (→ [Waveforms shown when recording](#))

Adjust the waveform display magnification before adjusting the headphone volume.

# Making recording settings

## Setting the recording file name format

Set the recording file name format.

1. Press .

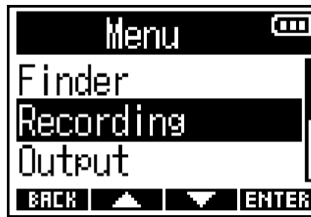

This opens the Menu Screen.

2. Use  /  to select "Recording" and press  to confirm.

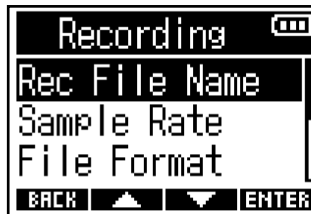

3. Use  /  to select "Rec File Name" and press  to confirm.



4. Use  and  to select the how files are named, and press  to confirm.

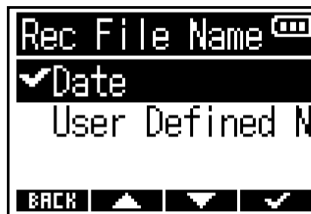

Item	Explanation
Date	Files are named with a "date_take number" format. The format of the date follows the "Date/Time" setting. (→ <a href="#">Setting the date format</a> ) Example: 210101_001.WAV
User Defined Name	Files are named with a "user input text_take number" format. Example: ZOOM_001.WAV

### NOTE:

If the "File Format" is set to "Mono" (→ [Selecting the recording file format \(Mono/Stereo\)](#)), "\_Tr1" (Input 1 recording file) or "\_Tr2" (Input 2 recording file) will be added after the take numbers in the file names.



5. If "User Defined Name" was selected, use ,  and  to input the characters used for file names.

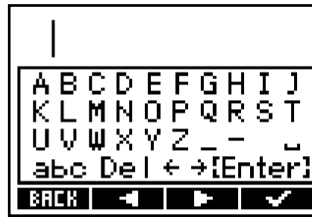

See [Character input screen](#) for how to input characters.

**NOTE:**

- Spaces and @ marks cannot be used at the beginnings of character strings.
- If no characters are input, file names will be only take numbers.

## Setting the sample rate

The sample rate used to record files can be set.

1. Press .

This opens the Menu Screen.

2. Use  /  to select "Recording" and press  to confirm.



3. Use  /  to select "Sample Rate" and press  to confirm.

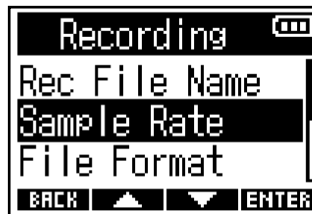

4. Use  /  to select the sample rate and press  to confirm.

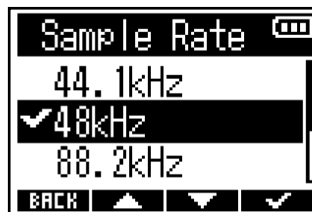

The following sample rates can be selected.

44.1kHz, 48kHz, 88.2kHz, 96kHz, 192kHz

### NOTE:

- 32-Bit float is always used for the recording bit depth.
- When 192kHz is selected, input signal delay (→ [Applying delay to input signals](#)) and line out delay (→ [Applying delay to line output](#)) are disabled.

## Selecting the recording file format (Mono/Stereo)

Mono or stereo can be selected for the WAV file recording format.

1. Press .

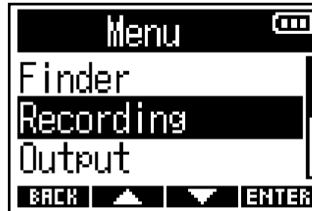

This opens the Menu Screen.

2. Use  /  to select "Recording" and press  to confirm.

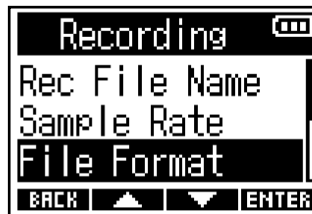

3. Use  /  to select "File Format" and press  to confirm.



4. Use  /  to select the recording file format and press  to confirm.



Item	Explanation
Mono	<ul style="list-style-type: none"><li>• One audio track is recorded in one file.</li><li>• If the "On/Off" setting for both Inputs 1 and 2 is "On" when recording, two WAV files will be created. (→ <a href="#">Turning inputs on/off</a>)</li></ul>
Stereo	<ul style="list-style-type: none"><li>• Two audio tracks are recorded in one file.</li><li>• The Input 1 signal is recorded on track 1 and the Input 2 signal is recorded on track 2 separately.</li></ul>

**NOTE:**

- Depending on the “File format” setting, the sound monitored from the headphone and line outputs will change as follows.

Mono: mono mix

Stereo: stereo with Input 1 on left channel and Input 2 on right channel

- Depending on the “File format” setting, the Home Screen appearance will change as follows.

Mono

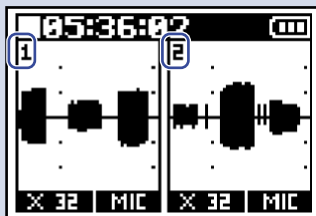

Stereo

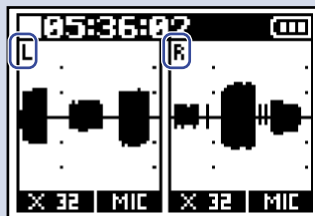
**HINT:**

When using only Input 1 or Input 2, making the following settings can increase battery operation time and reduce microSD card use.

- Turn off the input not being used. (→ [Turning inputs on/off](#))
- Set the Recording File Format to Mono. (→ [Selecting the recording file format \(Mono/Stereo\)](#))

# Capturing audio before recording starts (pre-recording)

The input signal is always buffered for a set amount of time, so it can be captured for up to 6 seconds before  is used to start recording (pre-recording).



This is useful when  is switched late, for example.

1. Press .

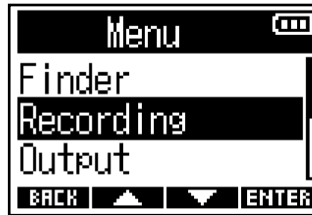

This opens the Menu Screen.

2. Use  /  to select "Recording" and press  to confirm.

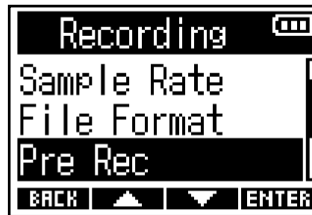

3. Use  /  to select "Pre Rec" and press  to confirm.



4. Use  /  to select "On" and press  to confirm.



The amount of pre-recording time when set to "On" depends on the sample rate setting. (→ [Setting the sample rate](#))

Sample rate	Pre-recording time
44.1 kHz	6 seconds
48 kHz	6 seconds
88.2 kHz	3 seconds
96 kHz	3 seconds
192 kHz	1 second

## Enabling the sound marker function

Half-second tone signals (sound markers) can be output from the output (PHONE OUT and LINE OUT) jacks when recording is started.



Since sound markers are also written to recording files, when recording audio for video with the F3, sending its output signal to the camera input can make synchronizing audio and video easier.

1. Press .

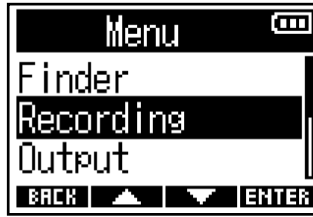

This opens the Menu Screen.

2. Use  /  to select "Recording" and press  to confirm.



3. Use  /  to select "Sound Marker" and press  to confirm.



4. Use  /  to select "On" and press  to confirm.

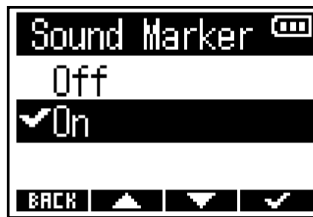

Use a stereo mini jack cable to connect the camera input jack to the F3 LINE OUT jack.

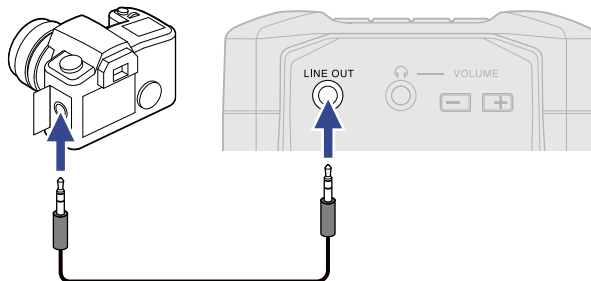



### NOTE:

Be careful with the volume if you are monitoring the input sound with headphones, for example.

## Setting the recording time display

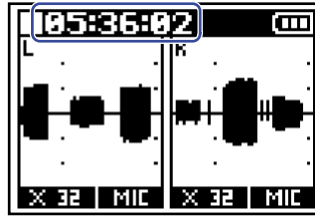
Either the elapsed recording time or the remaining possible recording time can be selected to be shown during recording.



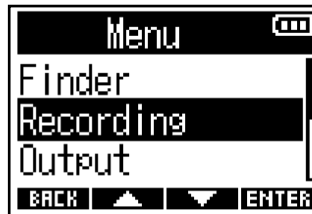

1. Press .  
This opens the Menu Screen.

2. Use  /  to select "Recording" and press  to confirm.



3. Use  /  to select "Rec Counter" and press  to confirm.



4. Use  /  to set the time to be shown and press  to confirm.

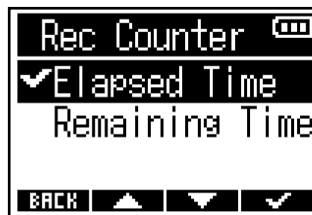

Item	Explanation
Elapsed Time	This shows the current elapsed recording time.
Remaining Time	This shows the remaining recordable time.

### NOTE:

If the file size exceeds 2 GB during recording, a new file will be created automatically and recording will continue without pause. If this happens, the elapsed recording time shown on the Home Screen will not be reset.

# Recording

1. Slide  to REC.

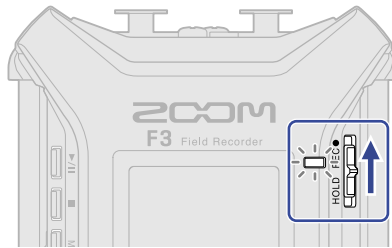

Recording will start and the REC LED will light red. The name, sample rate and bit depth of the file being recorded will be shown on the display.

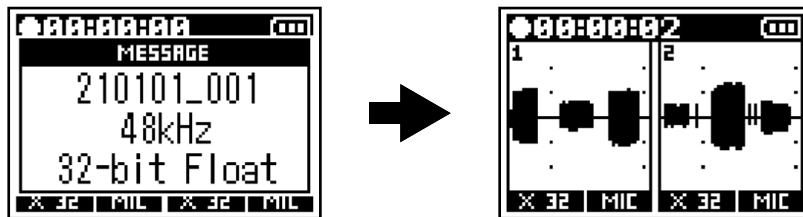

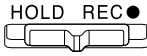

2. Press  to stop.

Misoperation during recording can be prevented by sliding  toward HOLD after recording starts. (→ [Preventing misoperation \(hold function\)](#))

## NOTE:

If the file size exceeds 2 GB during recording, a new file will be created automatically and recording will continue without pause. No gap in sound will occur between the two files when this happens.

## HINT:

- Sliding  toward REC again will also stop recording.
- Files are automatically saved at regular intervals during recording. If the power is interrupted or another problem occurs during recording, an affected file can be restored to normal by playing it with the F3.
- Recording can be started with  and stopped with  even when the Home Screen is not open, including on various settings screens. If starting or stopping recording is suddenly necessary while making settings, returning to the Home Screen is unnecessary. (Recording cannot be started from some screens.)



# Playing recordings

## Playing recordings

1. Press .

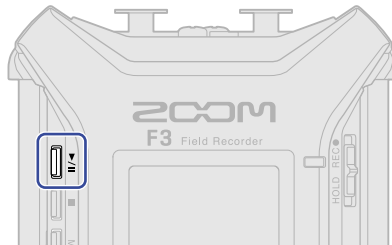

This starts recording. For details about the Playback Screen, see [Playback Screen](#).

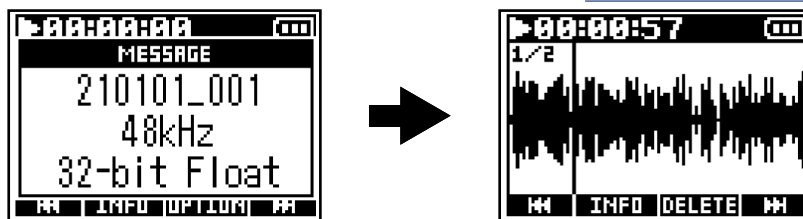

Files with the following characteristics can be played.

- 32-bit float WAV files
- Sample rate: 44.1 kHz, 48 kHz, 88.2 kHz, 96 kHz or 192 kHz
- Number of channels: 1 or 2

### NOTE:

- The playing file will be played back repeatedly.
- If the selected file is not valid, an "Invalid File!" message will appear.
- If no playable file exists, a "No File!" message will appear.

### HINT:

Files can also be chosen for playback as desired from a list. (→ [Selecting files for playback](#))

2. Press .

Playback stops and the Home Screen opens.

### NOTE:

Depending on the "File Format" setting used during recording, headphone and line output will change as follows during playback. (→ [Selecting the recording file format \(Mono/Stereo\)](#))

- Mono: mono mix
- Stereo: stereo with Input 1 on left channel and Input 2 on right channel

# Playback operations

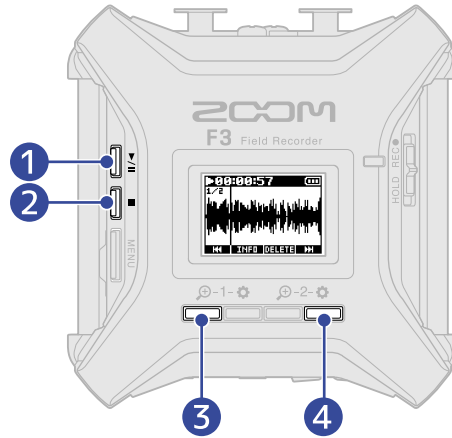

1



Press this to start and pause playback alternately.

2



Press this to stop playback.

3



Press this to select the previous file. If a file has marks, this will move to mark positions.  
Press and hold to search backward.

4



Press this to select the next file. If a file has marks, this will move to mark positions.  
Press and hold to search forward.

**NOTE:**

Marks can only be added by using the dedicated app on a smartphone or tablet. A BTA-1 or other dedicated wireless adapter is necessary to use the app on the smartphone/tablet for control. See the F3 Control operation manual for detailed explanations about marks.

# Checking playback file information

Various types of information about the playback file can be checked.

1. Press **INFO** when the Playback Screen is open.  
This opens the File Information Screen.



Use **▲** and **▼** to check the following types of information.

- Date and time recorded
- Recording format
- Recording file length

---

## HINT:

File information can also be checked by using the Finder, selected from the Menu Screen. (→ [Checking file information](#))

---

# Deleting recording files

The current playback file can be deleted.

1. Press **DELETE** when the Playback Screen is open.  
The Delete Screen will open.
2. Use **▲** / **▼** to select "Execute" and press **✓** to confirm.



## NOTE:

Be aware that if the "File Format" setting was "Mono", the two files recorded simultaneously by Inputs 1 and 2 will be deleted together by this action. (→ [Selecting the recording file format \(Mono/Stereo\)](#))

## HINT:

Files can also be deleted by using the Finder, selected from the Menu Screen. (→ [Deleting files](#))

# Managing files

Recording files on microSD cards can be selected, played and deleted, and information about them can be checked.

## F3 folder and file structure

When recording with the F3, files are created on microSD cards in the following manner.

File names differ according to the Rec File Name (→ [Setting the recording file name format](#)) and File Format (→ [Selecting the recording file format \(Mono/Stereo\)](#)) settings.

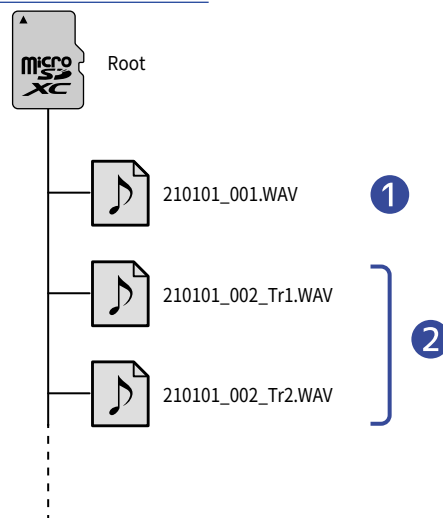

### 1 Stereo file

- Stereo files are created when the recording file format is "Stereo".
- Two audio tracks are recorded in one file.
- The Input 1 signal is recorded on track 1 and the Input 2 signal is recorded on track 2 separately.

### 2 Mono files



- Mono files are created when the recording file format is "Mono".
- One audio track is recorded in one file.
- If the "On/Off" settings of both Inputs 1 and 2 are set to "On" when recording, two WAV files will be created.
- "\_Tr1" and "\_Tr2" will be added to the ends of the names for the audio files recorded from Input 1 and Input 2.

# Selecting files for playback

Files can be selected from a list and played.

1. Press .



This opens the Menu Screen.

2. Use  /  to select "Finder" and press  to confirm.

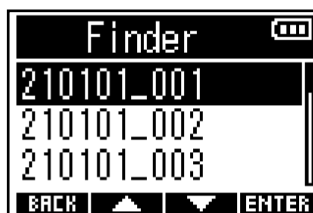

3. Use  and  to select the file desired for playback and press  to confirm.



4. Use  /  to select "Play" and press  to confirm.

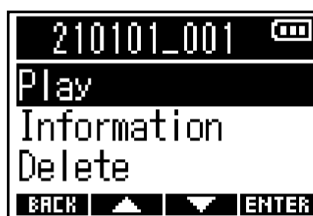

The selected file will start playing.

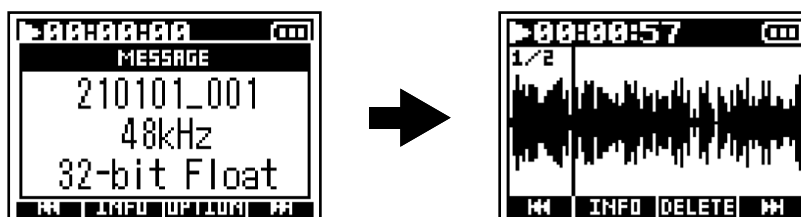

## NOTE:



- If the selected file is not valid, an "Invalid File!" message will appear.
- If no playable file exists, a "No File!" message will appear.
- Two files recorded simultaneously by Inputs 1 and 2 when the "File Format" setting was "Mono" will be shown as a single file in the F3 Finder. (→ [Selecting the recording file format \(Mono/Stereo\)](#))

# Checking file information



Various types of information about files can be checked.

1. Press .



This opens the Menu Screen.

2. Use  /  to select "Finder" and press **ENTER** to confirm.



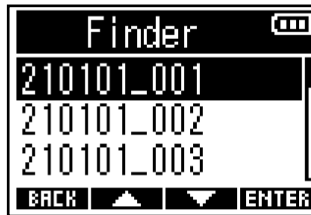

3. Use  and  to select the file with information to be checked and press **ENTER** to confirm.

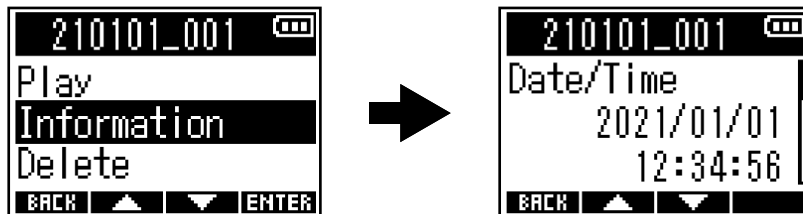

4. Use  /  to select "Information" and press **ENTER** to confirm.  
Information about the selected file will be shown.



Use  and  to check the various types of information.

---

## HINT:



- File information can also be checked from the Playback Screen. (→ [Checking playback file information](#))
  - For details about the information items that can be checked, see [Checking playback file information](#).
-

# Deleting files



Selected files can be deleted.

1. Press .

This opens the Menu Screen.

2. Use  /  to select "Finder" and press **ENTER** to confirm.



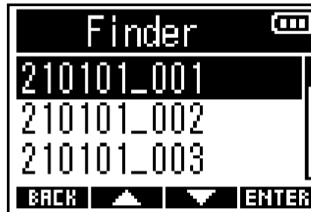

3. Use  and  to select the file to be deleted and press **ENTER** to confirm.



4. Use  /  to select "Delete" and press **ENTER** to confirm.



5. Use  /  to select "Execute" and press  to confirm.



## NOTE:

Two files recorded simultaneously by Inputs 1 and 2 when the "File Format" setting was "Mono" will be shown as a single file in the F3 Finder. Be aware that both recording files will be deleted together.

(→ [Selecting the recording file format \(Mono/Stereo\)](#))

## HINT:

Files can also be deleted on the Playback Screen. (→ [Deleting recording files](#))



# Using as an audio interface

The F3 can be used as a 2-in/2-out audio interface.

Signals input to the F3 can be sent to a computer, smartphone or tablet, and playback signals from a computer, smartphone or tablet can be output from the F3.

## Connecting computers, smartphones and tablets

1. Press .

This opens the Menu Screen.

2. Use  /  to select "USB Audio I/F" and press **ENTER** to confirm.



3. Use  /  to select the type of the device to be connected and press **ENTER** to confirm.



Setting	Explanation
PC/Mac	Connect a computer.
Tablet	Connect a smartphone or tablet. Use batteries to power the F3.

4. Use a USB cable to connect the F3 with the computer, smartphone or tablet.

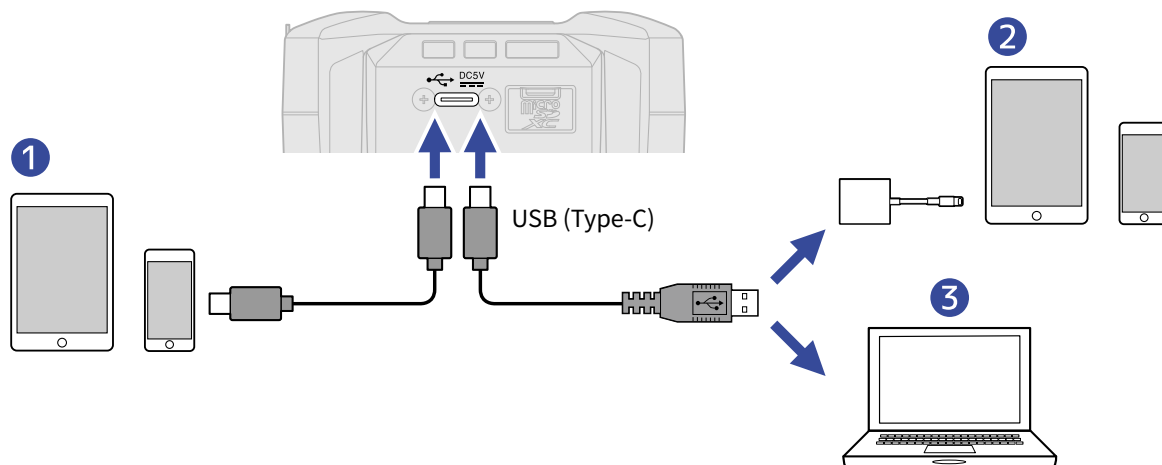

- ① Smartphone/tablet (Android)
- ② Smartphone/tablet (iOS/iPadOS)
- ③ Computer (Windows/Mac)

This opens the Audio I/F Screen.

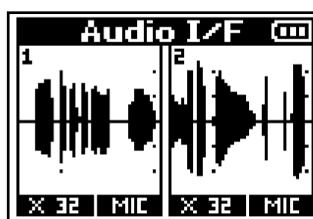

**NOTE:**

- Use a USB (Type-C) cable that supports data transfer.
- When connecting to a computer, set the F3 as the sound device.
- The bit depth when being used as an audio interface is 24-bit instead of 32-bit float.
- Use a Lightning to USB 3 Camera Adapter to connect to an iOS/iPadOS device with a lightning connector.

**HINT:**

For loop back and monitoring settings, see [Making audio interface settings](#).



## Disconnecting computers, smartphones and tablets

---

1. When connected as an audio interface, press .  
This opens the Menu Screen.

2. Use  /  to select "Exit USB Audio" and press  to confirm.



3. Use  /  to select "Execute" and press  to confirm.



4. Disconnect the USB cable that is connecting the F3 and the computer, smartphone or tablet.

# Making audio interface settings

Loop back and monitoring settings can be made when using the F3 as an audio interface.

## Enabling the loop back function



This function allows the playback sound from the computer, smartphone or tablet and the sound input to the F3 to be mixed and sent back to the computer, smartphone or tablet (loop back).

This function can be used to add narration to music played back from a computer and to record the mix or stream it on a computer, for example.

1. When connected as an audio interface, press  .  
This opens the Menu Screen.

2. Use  /  to select "Loop Back" and press  to confirm.





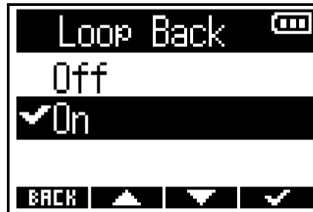

3. Use  /  to select "On" and press  to confirm.





## Enabling stereo monitoring

Use the Stereo Monitor setting to select a mono mix or stereo sound for monitoring Inputs 1 and 2.

1. When connected as an audio interface, press .  
This opens the Menu Screen.

2. Use  /  to select "Stereo Monitor" and press  to confirm.



3. Use  /  to select "Off (Mono Mix)" or "On (Stereo)" and press  to confirm.



Setting	Explanation
Off (Mono Mix)	The signals from Input 1 and 2 will be mixed in mono and can be monitored through the LINE OUT and PHONE OUT jacks.
On (Stereo)	The signals from Input 1 and 2 will be sent separately to left and right channels and can be monitored through the LINE OUT and PHONE OUT jacks.

# Controlling the F3 from a smartphone/tablet

By connecting a BTA-1 or other dedicated wireless adapter to the F3, it can be operated wirelessly from a smartphone or tablet using the dedicated F3 Control app.

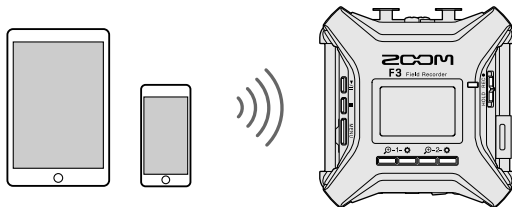

## NOTE:

- The dedicated F3 Control app must be installed on the smartphone/tablet beforehand. The F3 Control app can be downloaded from the App Store and Google play. For app setting and operation procedures, see the F3 Control app operation manual.
- The F3 cannot be controlled wirelessly from a smartphone/tablet when being used as an audio interface. (→ [Using as an audio interface](#))
- The F3 cannot be simultaneously connected to F3 Control and an UltraSync BLUE.

1. With the F3 power off, remove the REMOTE connector cover on the right side and connect a BTA-1 or other dedicated wireless adapter.

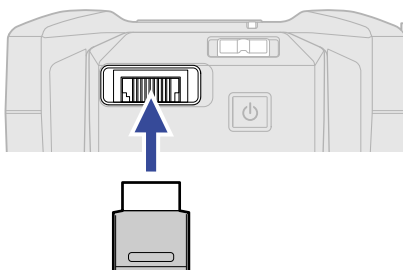

2. Press and hold  to turn the power on.

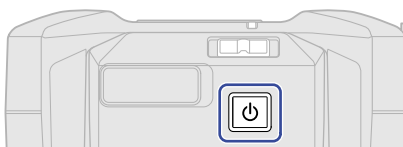

3. Use  /  to select "F3 Control" and press  to confirm.

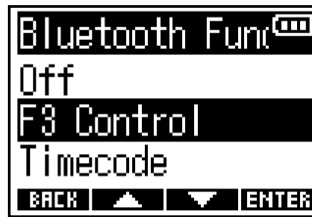

Searching for the connected device will begin and "Searching..." will appear on the display.



---

**HINT:**

- Searching can be canceled by pressing any button.
- Select  > System > Bluetooth Function > F3 Control to search for and connect with devices as well as to switch connected devices.

4. Launch the F3 Control app on the smartphone/tablet and conduct connection operations in the app. When connection completes, "F3 Control Connected!" will be shown.



For app setting and operation procedures, see the F3 Control app operation manual.

## Disconnecting from a smartphone/tablet

Quitting the app on the smartphone/tablet will end the connection.  
Disconnecting the BTA-1 will also end the connection between the F3 and F3 Control.



# Making various settings

## Setting the type of batteries used



Set the type of battery used in the F3 correctly so that the amount of remaining battery charge can be accurately displayed.

1. Press .

This opens the Menu Screen.

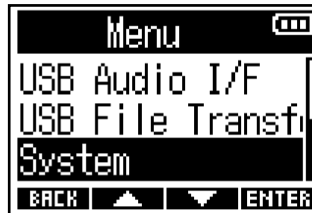
2. Use  /  to select "System" and press  to confirm.



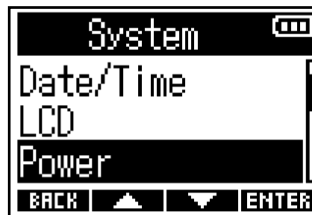

3. Use  /  to select "Power" and press  to confirm.

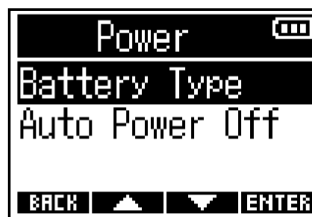

4. Use  /  to select "Battery Type" and press  to confirm.





5. Use  /  to select the battery type and press  to confirm.





Setting	Explanation
Alkaline	Alkaline batteries
Ni-MH	Nickel-metal hydride batteries
Lithium	Lithium batteries

# Setting the display backlight



To conserve energy, the display backlight can be set to turn off.

1. Press .

This opens the Menu Screen.

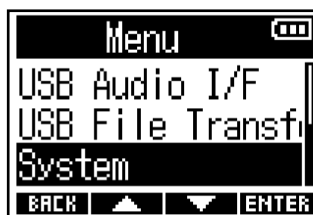
2. Use  /  to select "System" and press  to confirm.



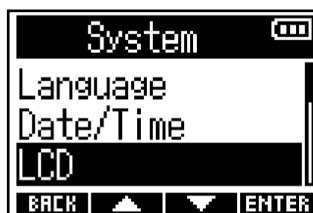

3. Use  /  to select "LCD" and press  to confirm.



4. Use  /  to select "Backlight" and press  to confirm.



5. Use  /  to select an item and press  to confirm.

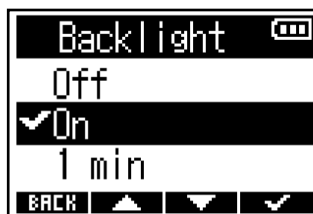



Setting	Explanation
Off	The display backlight always stays off.
On	The display backlight always stays on.
1 min	The display backlight will turn off after 1 minute elapses without operation.

# Setting the display contrast



If display content is difficult to see because it seems too bright or dark, adjust the contrast (display brightness level differences).

1. Press .

This opens the Menu Screen.

2. Use  /  to select "System" and press  to confirm.



3. Use  /  to select "LCD" and press  to confirm.

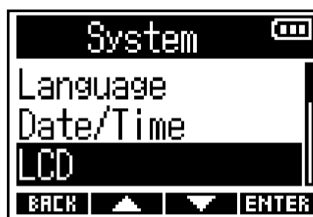

4. Use  /  to select "Contrast" and press  to confirm.



5. Use  /  to set the display contrast and press  to confirm.

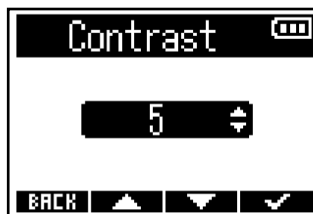

---

## HINT:

This can be set from 1 to 10.



---

# Setting the display language

The language used on F3 screens can be changed.

1. Press .

This opens the Menu Screen.

2. Use  /  to select "System" and press  to confirm.

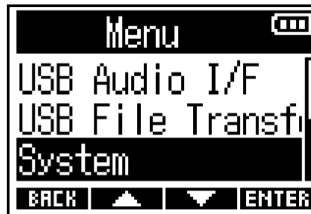

3. Use  /  to select "Language" and press  to confirm.



4. Use  and  to select the desired display language and press  to confirm.



---

## HINT:

This screen opens automatically the first time the power is turned on after purchase.

---

# Setting the date and time

The date and time added to recording files can be set.

When "Rec File Name" is set to "Date", the date when recording starts will be used for the file name.

(→ [Setting the recording file name format](#))

1. Press .

This opens the Menu Screen.

2. Use  /  to select "System" and press **ENTER** to confirm.

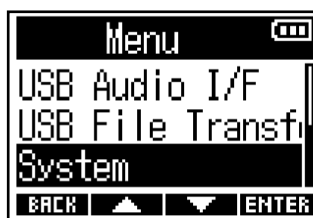

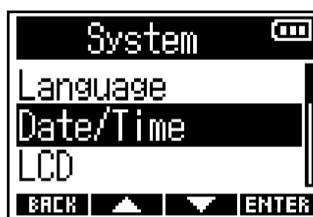

3. Use  /  to select "Date/Time" and press **ENTER** to confirm.



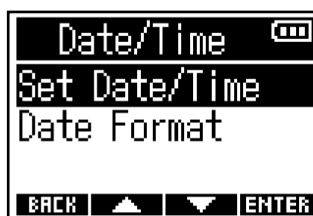

4. Use  /  to select "Set Date/Time" and press **ENTER** to confirm.

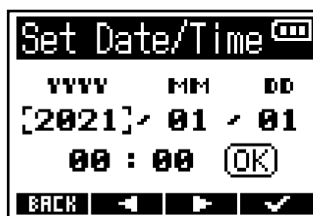

5. Use  and  to select the item to set and press  to confirm.



6. Use  and  to change the value and press **ENTER** to confirm.

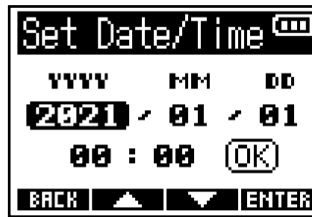

7. Repeat steps 5–6 to set the date and time.

8. After setting all items, use  and  to select **OK**, and press  to confirm.

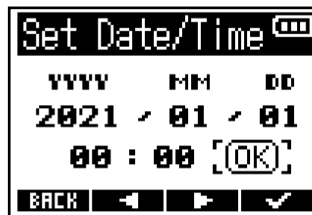

**NOTE:**

If the recording file name format is "Date" (→ [Setting the recording file name format](#)), the take number will be reset if the date is changed.

**HINT:**



This screen opens automatically after the language is set the first time the power is turned on after purchase.

# Setting the date format

The date format added to recording files can be changed.

1. Press .

This opens the Menu Screen.

2. Use  /  to select "System" and press  to confirm.

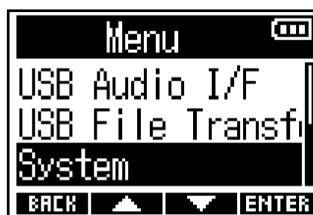

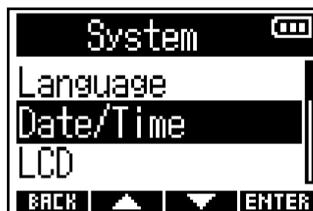

3. Use  /  to select "Date/Time" and press  to confirm.

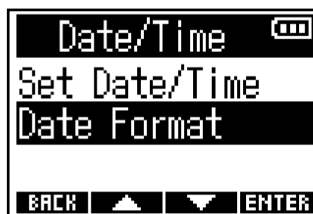

4. Use  /  to select "Date Format" and press  to confirm.



5. Use  /  to select the date format and press  to confirm.

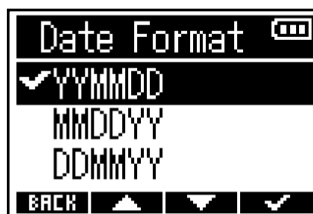

Setting	Explanation
YYMMDD	The date will be shown in year, month, day order.
MMDDYY	The date will be shown in month, day, year order.
DDMMYY	The date will be shown in day, month, year order.

**NOTE:**

If the recording file name format is "Date" (→ [Setting the recording file name format](#)), the take number will be reset if the date format is changed.





# Setting the time until the power turns off automatically



The F3 can be set to automatically turn its power off if it is not used for a set amount of time. To keep the power on at all times, set the automatic power saving function to "Off".

1. Press .

This opens the Menu Screen.

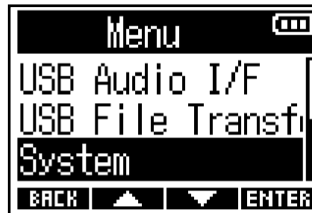
2. Use  /  to select "System" and press  to confirm.



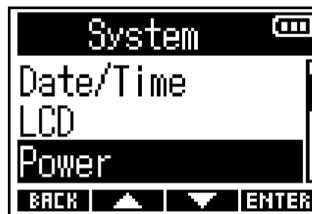

3. Use  /  to select "Power" and press  to confirm.

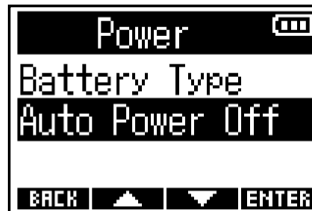

4. Use  /  to select "Auto Power Off" and press  to confirm.



5. Use  /  to select the time until the power turns off and press  to confirm.

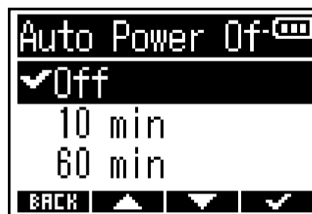

Setting	Explanation
Off	The power will not turn off automatically.
10 min	The power will automatically turn off if no operation occurs for 10 minutes.
60 min	The power will automatically turn off if no operation occurs for 60 minutes.

**NOTE:**

Regardless of the Auto Power Off setting, the power will not turn off automatically under the following conditions.

- When recording or playing
- When the F3 is being used as an audio interface
- When the F3 is being used as a card reader
- When a Bluetooth device is connected
- When a card is being tested
- When the firmware is being updated

# When using timecode

## Timecode overview

SMPT E timecode can be input to the F3 using an UltraSync BLUE made by Timecode Systems. Timecode is time information written to data when recording video and audio. It is used for video editing, control of other devices, and synchronization of audio and video, for example.

### NOTE:

- A Timecode Systems UltraSync BLUE cannot be used during audio interface operation. (→ [Using as an audio interface](#))
- The F3 cannot be simultaneously connected to F3 Control and an UltraSync BLUE.

## Using timecode for editing

If video and audio data both have recorded timecode, aligning them to a timeline and synchronizing them together is easy when using nonlinear editing software for editing.

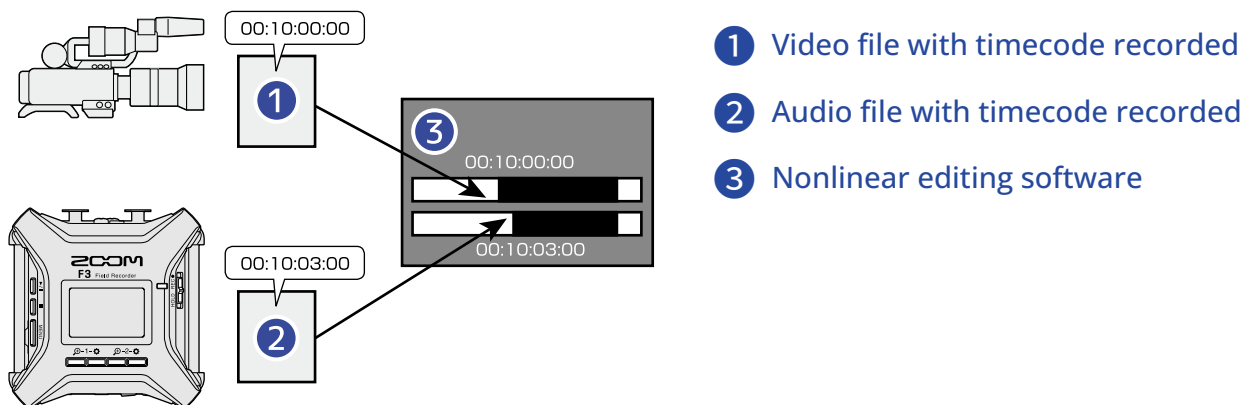

# Inputting timecode

By having the F3 and the video camera both receive timecode output by a Timecode Systems UltraSync BLUE, timecode can be recorded in both the audio data and the video data. The timecode is sent and received by Bluetooth.

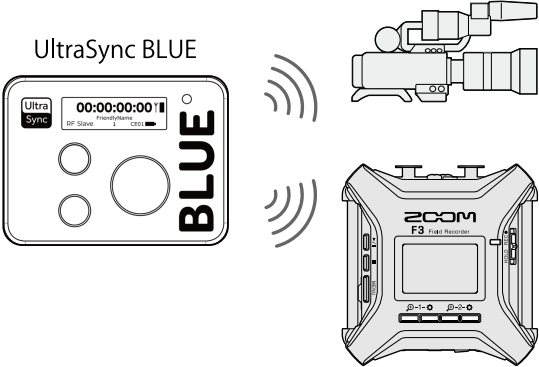

# Connecting with an UltraSync BLUE

The F3 can receive timecode from a connected UltraSync BLUE and record it in audio recording files. To connect an UltraSync BLUE, a BTA-1 or other dedicated wireless adapter must be connected to the F3, and the UltraSync BLUE and F3 must be paired.

1. With the F3 power off, remove the REMOTE connector cover on the right side and connect a BTA-1 or other dedicated wireless adapter.

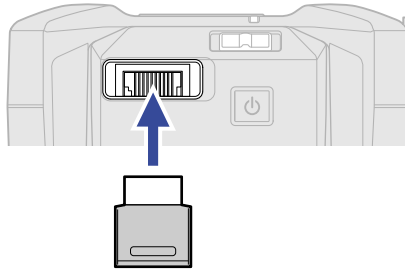

2. Press and hold  to turn the power on.

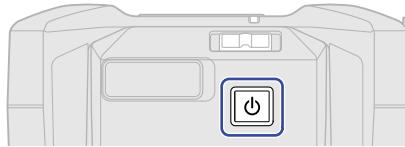

3. Use  /  to select "Timecode" and press **ENTER** to confirm.

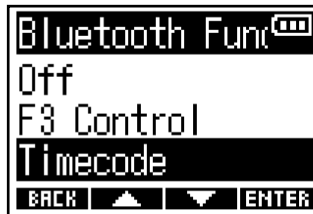

Searching for the connected device will begin and "Searching..." will appear on the display.



**NOTE:**

If the F3 and an UltraSync BLUE have been connected before, the following screen will appear where an option can be selected.

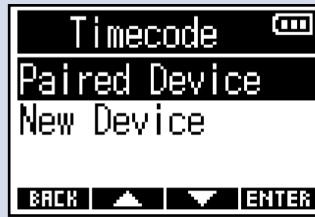

Setting	Explanation
Paired Device	Select this to connect with the previously connected UltraSync BLUE. In this case, the UltraSync BLUE will be connected and the operation on the UltraSync BLUE in step 4 becomes unnecessary.
New Device	Select this to connect to an UltraSync BLUE other than the one that was previously connected. If a new device is selected, previous device pairing data will be erased. In this case, proceed to step 4.

**HINT:**

- Searching can be canceled by pressing any button.
- Select  > System > Bluetooth Function > Timecode to search for and connect with devices as well as to switch connected devices.

#### 4. On the UltraSync BLUE, select the F3 as the connected device.

This starts pairing.

When pairing completes, "Timecode Device Connected!" will appear on the F3 display.

**HINT:**

- See the UltraSync BLUE manual for the procedures to select connected devices.
- Use the F3 and the UltraSync BLUE as close together as possible to make communication more reliable.
- If communication with the UltraSync BLUE is interrupted during recording, timecode data will not be added for the rest of the recording.

## Disconnecting from an UltraSync BLUE



Removing the BTA-1 will disconnect the F3 and the UltraSync BLUE and stop timecode recording. Pairing information will be retained even when disconnected.

## Checking timecode information

Information about the timecode being received from the UltraSync BLUE can be checked.

1. Press .

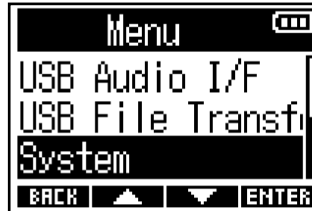

This opens the Menu Screen.

2. Use  /  to select "System" and press **ENTER** to confirm.

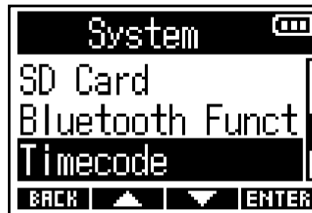

3. Use  /  to select "Timecode" and press **ENTER** to confirm.



4. Use  /  to select "Information" and press **ENTER** to confirm.

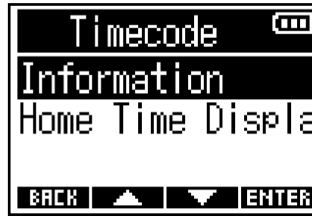

This shows information about the timecode.

The following types of information can be checked.

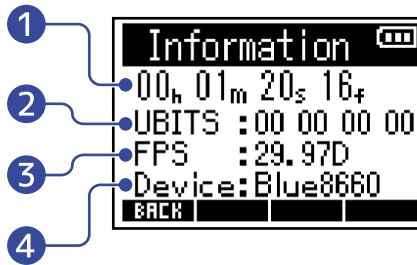



- 1 **Timecode**  
This shows the time in hours, minutes, seconds and frames.
- 2 **User bits (Ubits)**  
This shows the user bits set by the UltraSync BLUE.
- 3 **Frame rate (FPS)**  
This shows the frame rate.
- 4 **Device name (Device)**  
This shows the name of the UltraSync BLUE device.



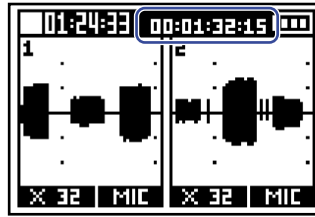

# Setting the time shown on the Home/Recording Screen

The display setting for timecode on the Home/Recording Screen can be changed. Timecode is shown in the position indicated below.



1. Press .  
This opens the Menu Screen.

2. Use  /  to select "System" and press **ENTER** to confirm.

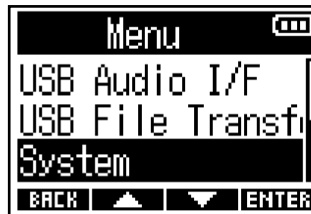

3. Use  /  to select "Timecode" and press **ENTER** to confirm.

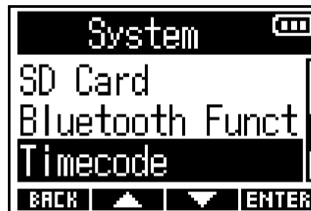

4. Use  /  to select "Home Time Display" and press **ENTER** to confirm.

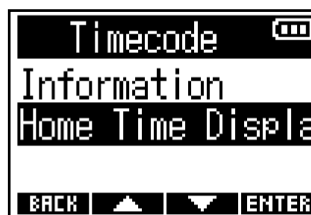

5. Use  /  to select the display setting and press  to confirm.

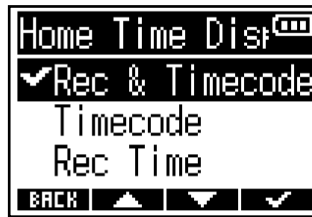

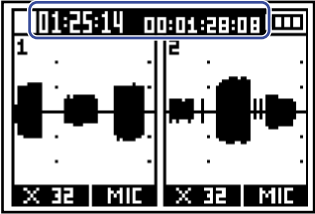
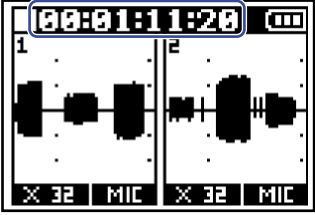
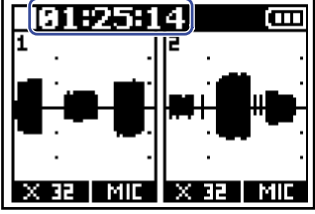
Setting	Explanation
Rec & Timecode	Both the recording time and the timecode will be shown. 
Timecode	Only the timecode will be shown. 
Recording time	Only the recording time will be shown. 

**NOTE:**



If an UltraSync BLUE is not connected, the timecode will be shown as "--:--:--".

# Exchanging data with computers

By connecting with a computer, data on the microSD card can be checked and copied.

1. Press .

This opens the Menu Screen.

2. Use  /  to select "USB File Transfer" and press **ENTER** to confirm.  
This opens the USB File Transfer Screen.

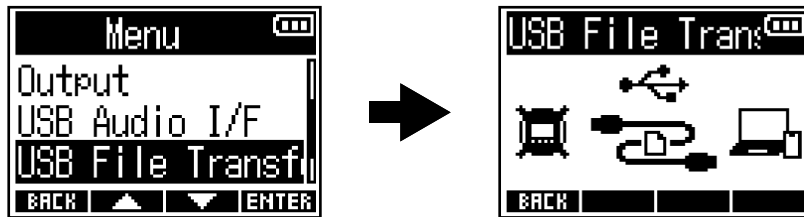

3. Use a USB (Type-C) cable to connect the F3 and the computer.

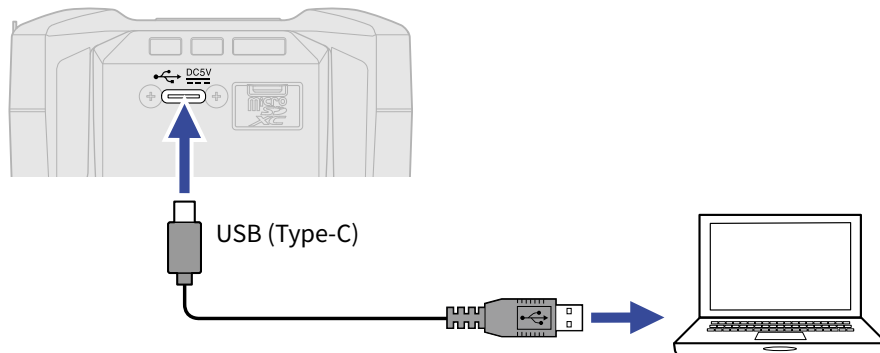

**NOTE:**

Use a USB (Type-C) cable that supports data transfer.

4. Use the computer to work with the files saved on the microSD card.

# Disconnecting a computer

## 1. Disconnect on the computer.

- Windows:  
Select the F3 with "Safely Remove Hardware".
- macOS:  
Drag the F3 icon to the Trash and drop it.

## 2. Disconnect the USB cable connecting the F3 with the computer.

**NOTE:**

Always conduct the removal procedure in step 1 before disconnecting the USB cable.

## 3. Press **BACK** to return to the Menu Screen.

# Testing microSD cards

---



You can test whether or not a microSD card can be used with the F3.

A basic test can be done quickly, while a full test examines the entire SD card.

## Conducting a quick test

1. Press .

This opens the Menu Screen.

2. Use  /  to select "System" and press **ENTER** to confirm.

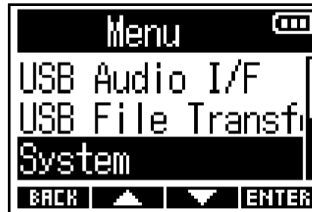

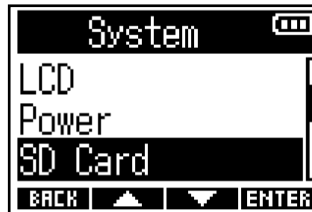

3. Use  /  to select "SD Card" and press **ENTER** to confirm.

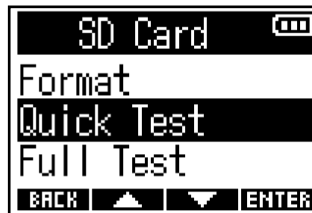

4. Use  /  to select "Quick Test" and press **ENTER** to confirm.



5. Use  /  to select "Execute" and press  to confirm.  
The card performance test will start.

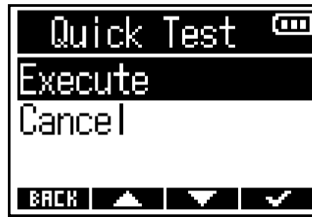

The result of the test will be shown when it completes.

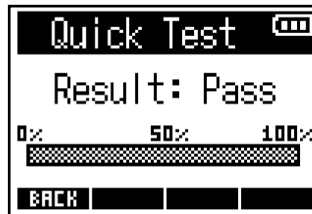

**NOTE:**

Even if a performance test result is "OK", there is no guarantee that writing errors will not occur. This information is just to provide guidance.



**HINT:**

A test can be canceled while in progress by pressing  .

# Conducting a full test

1. Press .

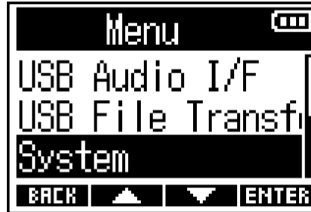

This opens the Menu Screen.

2. Use  /  to select "System" and press  to confirm.



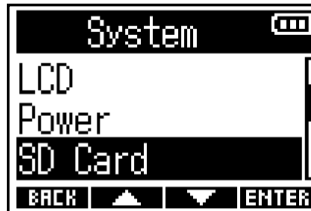

3. Use  /  to select "SD Card" and press  to confirm.

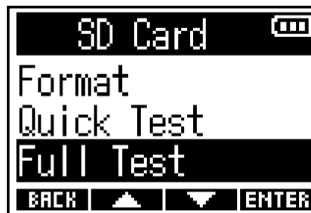

4. Use  /  to select "Full Test" and press  to confirm.



The amount of time required for the full test will be shown.

5. Use  /  to select "Execute" and press  to confirm.

The card performance test will start.



The result of the test will be shown when it completes.

If the access rate MAX reaches 100%, the card will fail.

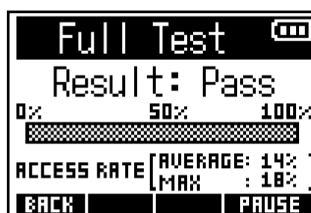

**NOTE:**

Even if a performance test result is "OK", there is no guarantee that writing errors will not occur. This information is just to provide guidance.

---

**HINT:**

The test can be paused by pressing **PAUSE** and resumed by pressing **RESTART** .

A test can be canceled while in progress by pressing **BACK** .

---



# Formatting microSD cards

To maximize the performance of a microSD card, use the F3 to format it.

1. Press .

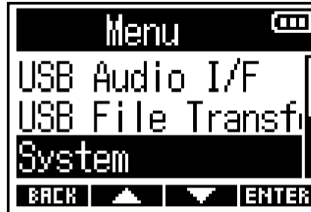

This opens the Menu Screen.

2. Use  /  to select "System" and press  to confirm.





3. Use  /  to select "SD Card" and press  to confirm.

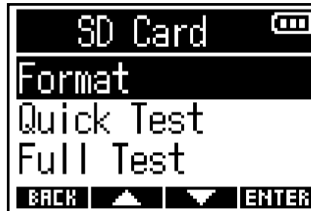

4. Use  /  to select "Format" and press  to confirm.



5. Use  /  to select "Execute" and press  to confirm.



This formats the microSD card.

## NOTE:

- Before using microSD cards that have just been purchased or that have been formatted on a computer, they must be formatted by the F3.
- Be aware that all data previously saved on the microSD card will be deleted when it is formatted.



# Restoring factory default settings

---

The F3 can be restored to factory default settings.

1. Press .

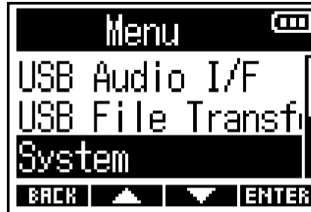

This opens the Menu Screen.

2. Use  /  to select "System" and press  to confirm.

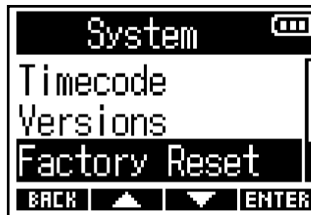

3. Use  /  to select "Factory Reset" and press  to confirm.



4. Use  /  to select "Execute" and press  to confirm.



After the F3 is restored to its factory default settings, the power will turn off.

**NOTE:**

Conducting a factory reset will overwrite all settings to their factory defaults. Be certain before using this function.

# Managing the firmware

## Checking the firmware versions

The firmware versions used by the F3 can be checked.

1. Press .

This opens the Menu Screen.

2. Use  /  to select "System" and press **ENTER** to confirm.

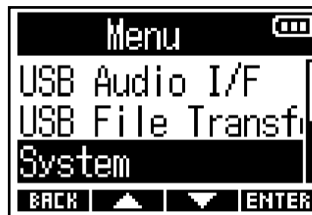

3. Use  /  to select "Versions" and press **ENTER** to confirm.

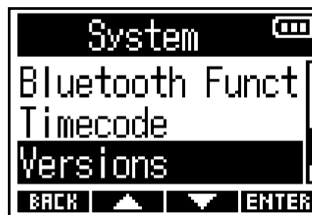

This shows the firmware versions.

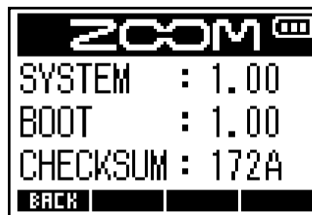

## Updating the firmware

The F3 firmware can be updated to the latest versions.

Files for the latest firmware updates can be downloaded from the ZOOM website ([zoomcorp.com](http://zoomcorp.com)).

Follow the instructions in the "F3 Firmware Update Guide" on the F3 download page.

# Appendix

---

## Troubleshooting

If you think that the F3 is operating strangely, check the following items first.

### Recording/playback trouble

---

#### There is no sound or output is very quiet

- Check the orientation of the mics or the volume settings of the connected equipment.
- Confirm that the headphone volume and line output level are not too low. (→ [Monitoring input/playback sounds](#), [Adjusting line output levels \(playing test tones\)](#))

#### Sound from connected equipment or inputs cannot be heard or is very quiet

- Increase the magnification of input signal waveforms to amplify their sound when monitoring. (→ [Waveforms shown when recording](#))
- If a CD player or other equipment is connected to an input jack, raise the output level of that device.
- Check the input signal monitoring settings. (→ [Monitoring input/playback sounds](#), [Adjusting line output levels \(playing test tones\)](#))
- Check the phantom power settings. (→ [Setting input sources](#), [Changing phantom power voltage](#))

#### Recording not possible

- Confirm that the REC LED is lit red. (→ [Recording](#))
- Confirm that the microSD card has open space. The time available for recording can be checked on the screen when recording is paused. (→ [Home Screen](#))
- Confirm that a microSD card is loaded properly in the card slot. (→ [Inserting microSD cards](#))
- Confirm that the input source setting is not "Off". (→ [Setting input sources](#))

#### Recorded sound cannot be heard or is very quiet

- Confirm that the input source setting is correct for the connected equipment. (→ [Setting input sources](#))

## Other trouble

---

### Power will not turn on

- Confirm that  has not been set to "HOLD". (→ [Preventing misoperation \(hold function\)](#))

### Computer does not recognize it even though it is connected to a USB port

- The operation mode must be set on the F3 to allow the computer to recognize it. (→ [Exchanging data with computers, Connecting computers, smartphones and tablets](#))

### Battery operation time is short

Making the following settings could increase the battery operation time.

- Set the battery type being used correctly. (→ [Setting the type of batteries used](#))
- Turn unnecessary inputs off. (→ [Turning inputs on/off](#))
- Set the phantom power voltage to 24 V. (→ [Changing phantom power voltage](#))
- Turn the display backlight off or set it to turn off after being unused for a certain amount of time. (→ [Setting the display backlight](#))
- Reduce the sample rate used to record files. (→ [Setting the sample rate](#))
- Disconnect unnecessary cables from the PHONE OUT and LINE OUT jacks.
- Due to their characteristics, using nickel metal hydride batteries (especially high-capacity ones) or lithium batteries should enable longer use than alkaline batteries when power consumption is high.

# Block diagram

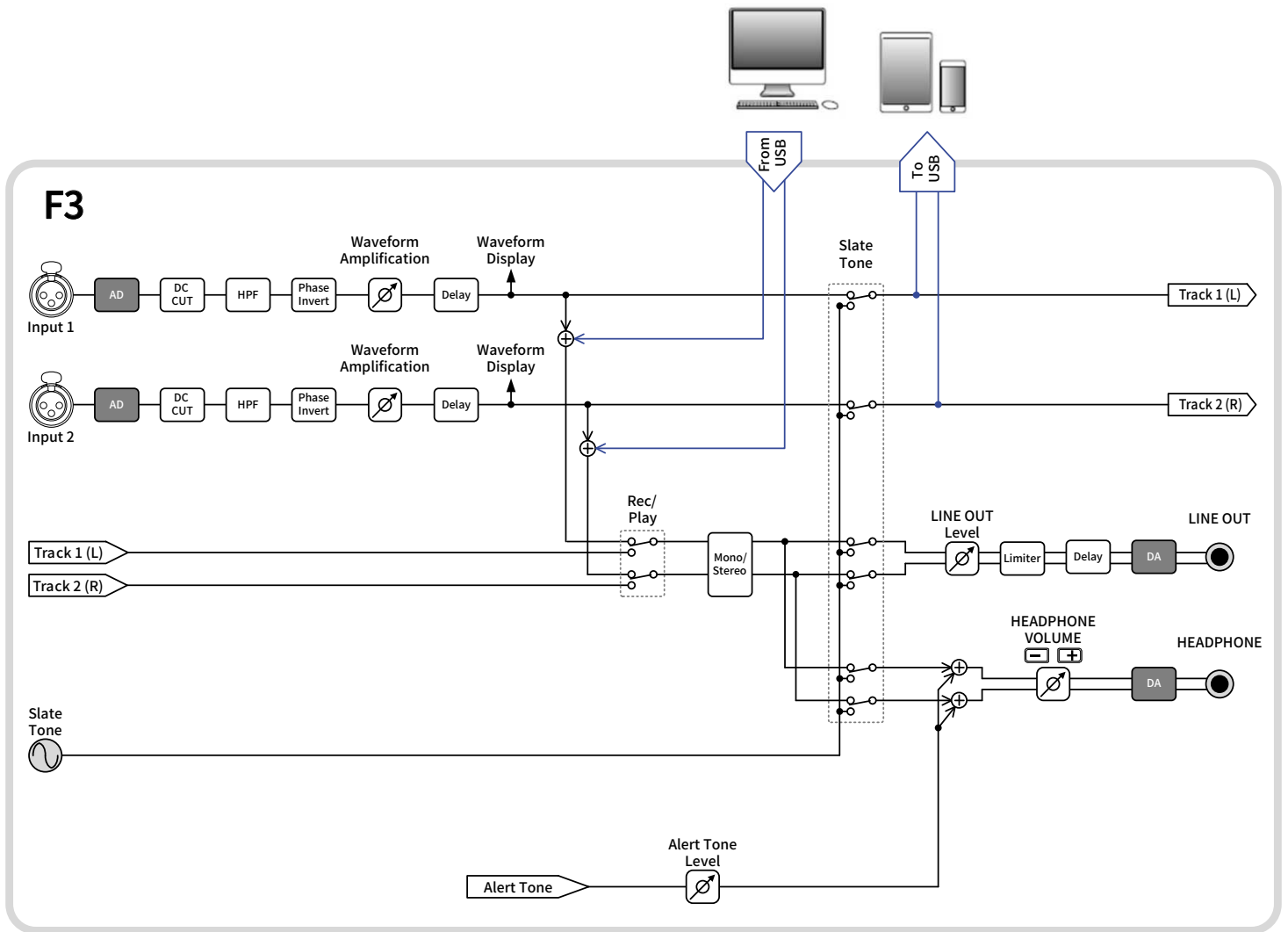

# Specifications

Input and output channels	Inputs	MIC/LINE (mono)	2
	Outputs	LINE OUT	1
		PHONE OUT	1
Inputs	MIC/LINE (mono)	Connectors	2 XLR (2: HOT)
		Input gain	Adjustment unnecessary (dual AD converter circuits used)
		Input impedance	MIC: 3 k $\Omega$ or more LINE: 3 k $\Omega$ or more
		Maximum input level	MIC: +4 dBu LINE: +24 dBu
		Phantom power	+24/48 V Combined channel total of 10 mA or less
		Equivalent input noise	-127 dBu or less (IHF-A) when waveform magnification is $\times 1024$ with 150 $\Omega$ input
		Outputs	LINE OUT
Maximum output level	+1 dBu		
Output impedance	100 $\Omega$ or less		
PHONE OUT	Connector		1 stereo mini jack
	Maximum output level		50 mW + 50 mW (into 32 $\Omega$ load)
	Output impedance		15 $\Omega$ or less
	Recorder		Maximum simultaneous recording tracks
Maximum simultaneous playback tracks		2	
Recording format		WAV 44.1/48/ 88.2/96/192 kHz, 32-bit float mono/stereo BWF and iXML formats supported	
Recording media		4 - 32 GB cards compatible with the microSDHC specification 64 GB - 1 TB cards compatible with the microSDXC specification	
Display	LCD with backlight (96 $\times$ 64 resolution)		

USB	Connector	USB Type-C • Use a USB cable that supports data transfer. USB bus power is supported.
	Audio interface operation	USB2.0 High Speed 44.1/48/88.2/96 kHz, 24-bit 2-in/2-out
	Mass storage operation	USB 2.0 High Speed
REMOTE		Dedicated wireless adapter (ZOOM BTA-1)
Power		2 AA batteries (alkaline, NiMH or lithium) AC adapter (ZOOM AD-17): DC 5 V/1 A • USB bus power is supported.
Estimated continuous operation time using batteries • The values are approximate. • Continuous battery operation times were determined using in-house testing methods. They will vary greatly according to use conditions.	48 kHz/32-bit float, 2ch recording to microSDHC card (without headphones, PHANTOM off, LCD Backlight off)	Alkaline batteries: about 8 hours NiMH batteries (1900 mAh): about 8.5 hours Lithium batteries: about 18 hours
	48 kHz/32-bit float, 2ch recording to microSDHC card (headphones into 32Ω load, PHANTOM at 48 V (5 mA), LCD Backlight off)	Alkaline batteries: about 2 hours NiMH batteries (1900 mAh): about 3 hours Lithium batteries: about 7.5 hours
Power consumption		5 W maximum
Dimensions		75.0 mm (W) × 77.3 mm (D) × 47.8 mm (H)
Weight (including batteries)		242 g

Note: 0 dBu = 0.775 Vrms





ZOOM CORPORATION

4-4-3 Kanda-surugadai, Chiyoda-ku, Tokyo 101-0062 Japan

[zoomcorp.com](https://zoomcorp.com)