

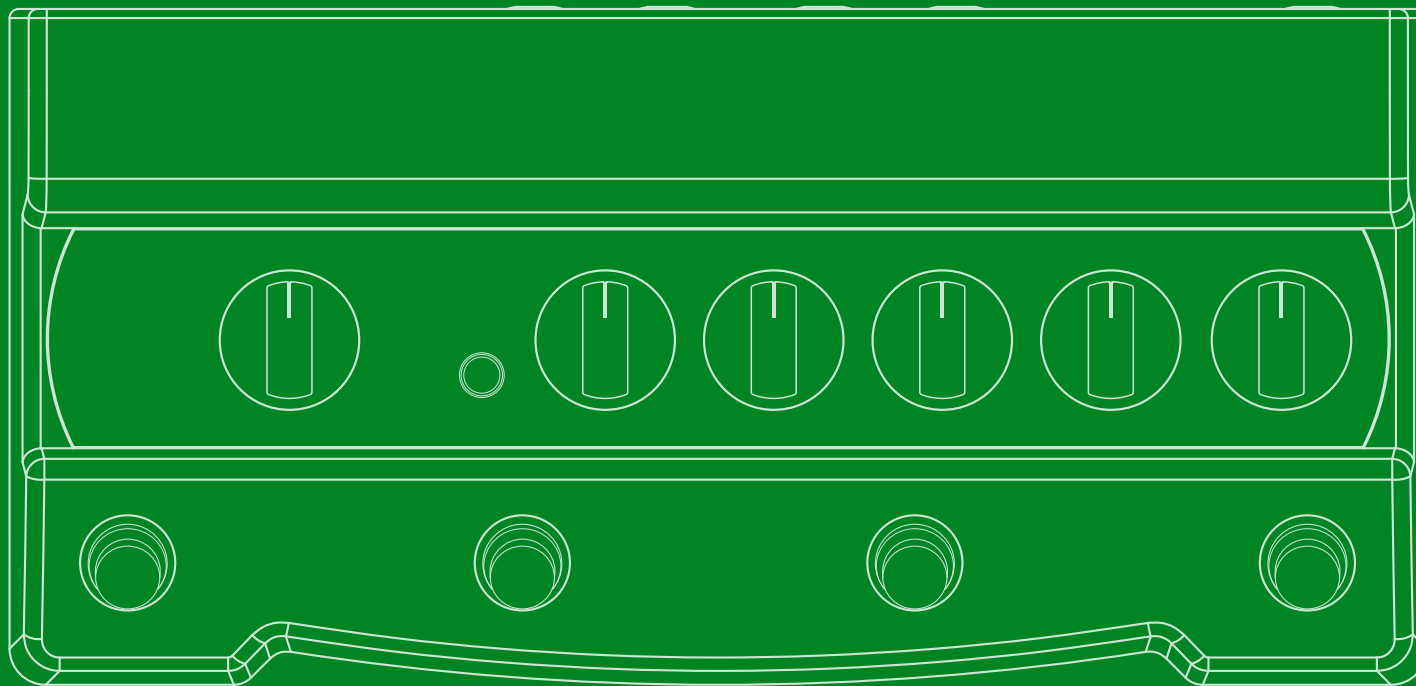

DL4 MKII



1.0 OWNER'S MANUAL >

Contents

Welcome to DL4 MkII	4
What's In the Box?	4
Features	4
Updating DL4 MkII Firmware	4
Top Panel	5
Rear Panel	7
Quick Start	8
Hooking It All Up	8
Basic Operation	10
Working with Presets	10
Loading Presets A, B, and C	10
Loading Presets D, E, and F	10
Loading Presets 1 - 128 via MIDI	10
Saving a Preset	11
Restoring Factory Presets	12
About Tap Tempo	12
Configuring Delay and Reverb Routing	13
Stereo vs. Mono Output	13
Setting up an Expression Pedal and Footswitches	14
Configuring One or More Parameters for Pedal Control	15
Configuring Footswitch Control Options	17
Controlling The Classic Looper Parameters	17
Using a Microphone	18
Using the Looper	19
"Should I Use the Classic Looper or the 1 Switch Looper?"	19
Using a microSD Card	20
Preparing your microSD Card for Use with DL4 MkII	20
Setting the Looper to Mono vs. Stereo	20
Configuring the Looper Pre/Post Effects	20
Using the Classic Looper	21
Using the 1 Switch Looper	23
More Tasty Looping Tidbits	24

Effects Models	25
MkII Delays List	25
Legacy Delays List	26
Secret Reverbs List and Controls	27
Model Gallery	29
MkII Delays	29
Legacy Delays	34
Secret Reverbs	39
U.S. Registered Trademarks	42
Global Settings	43
Accessing the Global Settings	43
Global Settings Table	44
MIDI	49
Using MIDI Clock for Tempo Sync	49
Accessing all 128 Presets	50
Controlling Parameters	51
Controlling the Looper	53
Additional Resources	54
Product Specifications	54
Online Resources	54

**Supplier's Declaration of Conformity
47 CFR § 2.1077 Compliance Information**

Unique Identifier: Line 6® DL4™ MkII

Responsible Party - U.S. Contact Information:

Yamaha Guitar Group, Inc.
26580 Agoura Road
Calabasas, CA 91302-1921
(818) 575-3600
<https://line6.com/>

FCC Compliance Statement:

This device complies with Part 15 of the FCC Rules. Operation is subject to the following two conditions: (1) This device may not cause harmful interference, and (2) this device must accept any interference received, including interference that may cause undesired operation.

© 2022 Yamaha Guitar Group, Inc. All rights reserved.

Line 6, the Line 6 logo, DL4, Helix, HX, and Powercab are trademarks or registered trademarks of Yamaha Guitar Group, Inc. in the U.S. and/or other jurisdictions. Mac is a trademark of Apple, Inc. registered in the U.S. and other countries. Apple is not responsible for the operation of this device or its compliance with safety and regulatory standards. Windows is a registered trademark of Microsoft Corporation in the United States and/or other countries.

Welcome to DL4 MkII

“I never read manuals!”

Yeah, we’ve heard that. Yet, despite our hurt feelings, we’ve tirelessly persisted to document all the glorious features, tips, and tricks for the Line 6® DL4™ MkII effects pedal. There are plenty of pictures, and even a [“Quick Start”](#) section to get you up and running (and don’t forget to read the printed *Cheat Sheet* that came with your device). If video is your preferred medium of choice, we’ve got something for you too!

Go here, line6.com/meet-dl4mkii:



What the heck did I just buy?

Thanks for your purchase, and congratulations on being the proud owner of a shiny new DL4 MkII effects pedal. We hope that your recent acquisition will make your creative life more fun, exciting, and bring you one step closer to achieving inner peace with your audio gear agglomeration.

If you’re savvy with the original, award-winning Line 6 DL4 Delay Modeler (wow, was that really over 20 years ago?), then you pretty much already know how to get going with this new green machine. But when it comes to features, you don’t know the half of it! We’ve packed in **all** the sonic goodies and functionality of the classic DL4, plus an entirely new set of MkII delays & reverbs, improved looping, mic input, MIDI control, and more! So, you’ll want to give this manual at least a quick look—Don’t worry, we’ll try and make it as painless as possible.

What’s In the Box?

- Line 6 DL4 MkII effects pedal
- Line 6 DC-1G power adapter
- USB cable
- *DL4 MkII Cheat Sheet* (read that one first!)
- Warranty card

Features

- 15 new MkII delay models
- 15 original DL4 delay models
- 15 “secret” reverb models
- An improved Looper, plus a new 1 Switch Looper option, offering 240 seconds mono or 120 seconds stereo record time—and much longer with a microSD™ card (not included)
- 128 customizable preset locations (6 via footswitches, and an additional 122 via MIDI)
- MIDI IN, OUT/THRU, and USB MIDI for preset, parameter, and Looper control
- Stereo in/Stereo out, via 1/4" (unbalanced) jacks
- True analog bypass, as well as options for DSP or Buffered bypass
- Tap Tempo and MIDI Clock tempo sync
- 4 on-board, multi-function footswitches with colored LED indicators
- External expression pedal + footswitch (or dual external footswitch) connectivity, configurable for preset, parameter, or Looper control
- XLR Mic In, with built-in preamp and input level adjustment
- USB C for external MIDI control and easy firmware updating

Updating DL4 MkII Firmware

If a newer firmware version becomes available for your DL4 MkII device, it is highly recommended to update, which can be accomplished easily using the free **Line 6 Updater** application!

First, install the latest Line 6 Updater software on your Mac or PC (available at line6.com/software), connect DL4 MkII to your computer’s USB port, and Line 6 Updater will check online and let you know if a newer firmware version is available. If so, the Line 6 Updater app will then walk you through performing a firmware update within minutes.

Top Panel

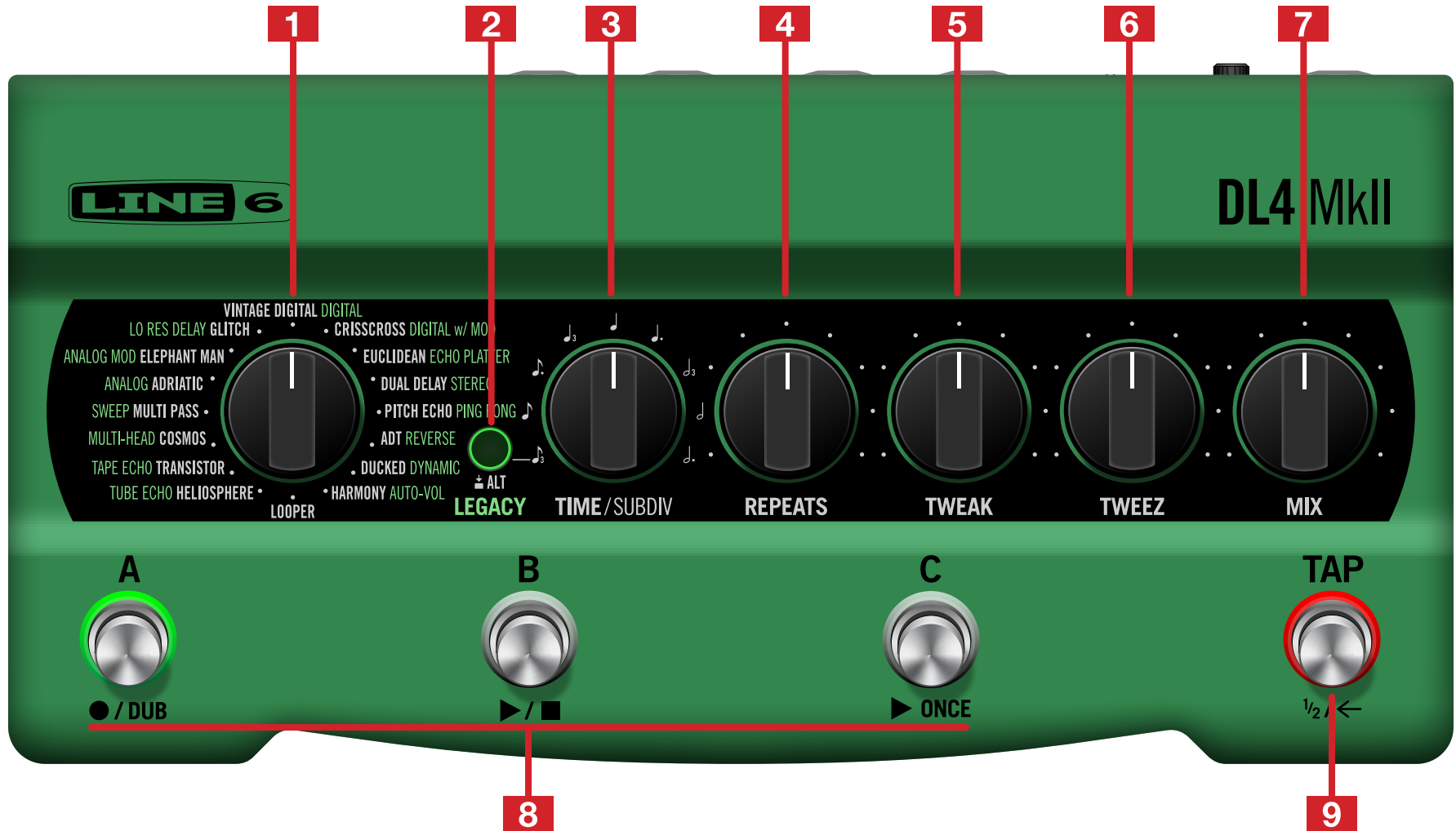

- 1. Model Selector** Turn to choose the desired delay, Classic Looper, or reverb model.

Toggle the ALT/LEGACY button to MkII (LED is not lit) and turn the knob to choose any MkII delay. The MkII delays are those labeled in white text. See "[MkII Delays on page 29](#)".

Toggle the ALT/LEGACY button to Legacy (LED is lit green) and turn the knob to choose any classic DL4 delay. The Legacy delays are those labeled in green text. See "[Legacy Delays on page 34](#)".

Press and hold the ALT/LEGACY button while turning the knob to choose any reverb. See "[" on page 26](#)".

- 2. ALT/LEGACY Button** As noted throughout this manual, you'll press or press-hold this button to modify the behavior of the knobs to access alternate functions, such as MkII vs. original DL4 delay models and parameters, secret reverb options, Looper functions, global settings, and more.

- 3. TIME/SUBDIV** Turn to choose the desired delay repeat time. Hold the ALT/LEGACY button while turning to choose a note subdivision value (from 1/8th note triplet to dotted 1/2 note) of the current Tap Tempo. Note that your TIME setting and Tempo are stored individually per saved preset (or your Tempo can be set as Global—see "[Global Settings on page 43](#)").

- 4. REPEATS** Turn to get the desired number of delay repeats, or press-hold the ALT/LEGACY button while turning to adjust the amount of decay time for the reverb.

For most delay models, you'll get a single repeat at the minimum setting, and infinite repeats at maximum for that runaway feedback effect (or "Squeal," as we like to call it), reminiscent of the tape echo machines of yore.*

For reverb models, you can adjust the decay from 0 ms at minimum, with the maximum decay time varying up to several seconds, depending on the specific reverb model you're using.

 ***TIP:** You can set a footswitch to "Squeal" to instantly toggle the infinite delay repeats setting to trigger it at will—see "[Global Settings on page 43](#)".

- 5. TWEAK** Turn to adjust the assigned delay model's parameter, or press-hold ALT/LEGACY and turn the knob to adjust the assigned reverb model's parameter. See "[Effects Models on page 25](#)" for the lists of TWEAK-assigned parameters per model).

When you have the Model Selector set to LOOPER, use the TWEAK knob to adjust the amount of modulation for the Classic Looper's built-in echo effect—also see "[Using the Classic Looper on page 21](#)".

- 6. TWEEZ** Turn to adjust the assigned delay model's parameter. See "[Effects Models on page 25](#)" for the lists of TWEEZ-assigned parameters per delay model).

Hold the ALT/LEGACY while turning to choose the signal routing for the delay and reverb effects. See "[" on page 12](#)".

When you have the Model Selector set to LOOPER, use this knob to adjust the volume of the repeats for the Classic Looper's echo effect, from 0 (essentially, echo is "off") to a 50/50 mix of dry signal/echo repeats. See "[Using the Looper on page 19](#)" for more details.

- 7. MIX** Turn to adjust the balance between the dry and delay-effected signal, or press and hold ALT/LEGACY to adjust the mix of the reverb-effected signal.

When using the Classic Looper, turn to adjust the playback level of your recorded loop.

- 8. Footswitches A, B, and C** Press these footswitches to recall and toggle presets A, B, or C, respectively.* You'll see the footswitch's LED lit green when the preset is active—press the lit footswitch to bypass the pedal. Press and hold the current footswitch until the LED flashes to save your current settings to its preset location.

When you have the Model Selector set to LOOPER, these switches perform the Looper functions as labeled below each switch: Record/Overdub, Play/Stop, and Play Once.

 ***NOTE:** Optionally, configure the TAP footswitch for **Presets DEF** to allow you to toggle footswitches A, B, C to access either presets A, B, and C **or** D, E, and F. See "[Global Settings on page 43](#)".

You can alternatively access 128 presets via external MIDI—see "[MIDI on page 49](#)".

- 9. TAP Footswitch** You'll see the red LED surrounding this footswitch flash to indicate the current rate for your delay repeats. Turn the TIME knob to change the rate from fast to slow. (The longest delay time varies among delay model types.)

Alternatively, stomp on this footswitch rhythmically to set a "tap tempo" to which the delay models can follow. Press-hold ALT/LEGACY and turn TIME to choose a note subdivision value for your delay repeats to follow. See "[About Tap Tempo on page 12](#)".

When you have the Model Selector set to LOOPER, toggling this switch changes the Looper between half and full speed, and double-pressing this switch changes between forward and reverse.

 **TIP:** You can alternatively configure the TAP footswitch to be a dedicated on/off switch for the 1 Switch Looper, or for other functions—see the Global Settings - "[TAP Footswitch Assign on page 44](#)".

Rear Panel

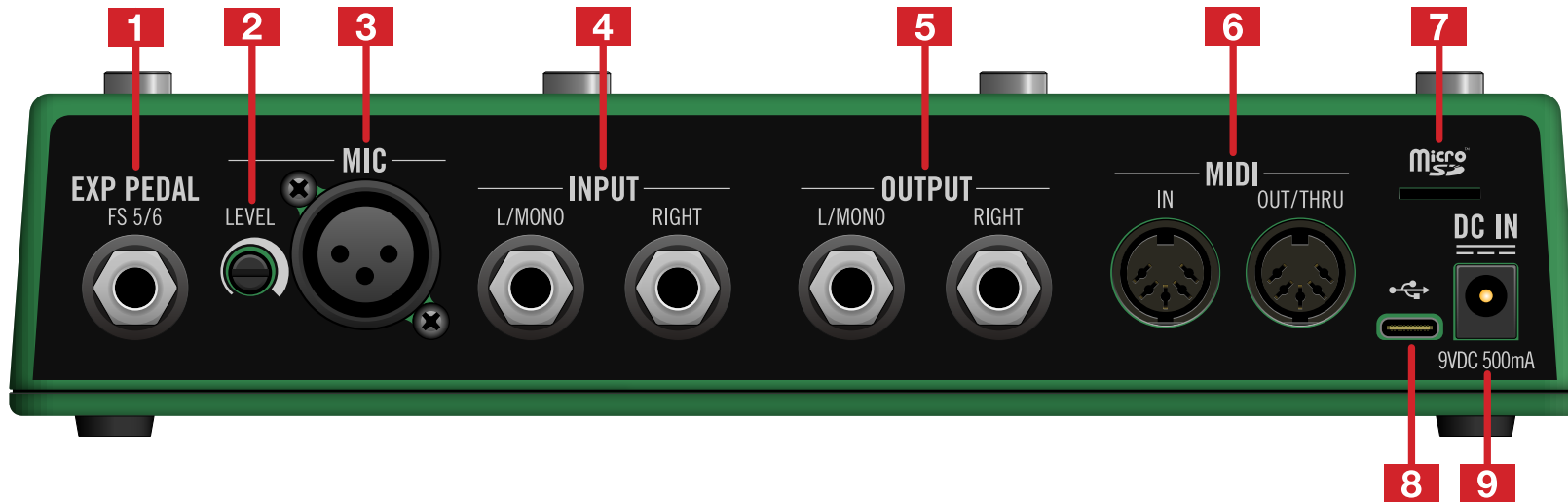

- 1. EXP PEDAL - FS 5/6** Connect an expression pedal here to adjust a wide variety of parameters. With a Y-cable adapter, you can connect an expression pedal plus a footswitch, or connect two footswitches, for even greater control! When purchasing external footswitches, you'll want to get the momentary (unlatched) type. See ["Setting up an Expression Pedal and Footswitches" on page 14](#) for details.
- 2. MIC LEVEL Knob** Adjust this trim knob to optimize the level for the signal coming into the XLR Mic Input. If you see the LED ring around the top panel's ALT/LEGACY button light up red, it indicates the signal is too hot—turn the LEVEL down to avoid clipping and unwanted distortion.
- 3. MIC Input** Plug your dynamic microphone into this XLR input, adjust the MIC LEVEL knob, and see just what DL4 MkII can do with some vocals—or anything else you want to mic up. See [" on page 17](#).
- 4. INPUT L/MONO, RIGHT** Connect your guitar, bass guitar, or mono pedals to the L/MONO input. Connect those fancy stereo pedals, keyboards, synths, or modelers to both the L/MONO and RIGHT inputs. See ["Hooking It All Up" on page 8](#).
- 5. OUTPUT L/MONO, RIGHT** Connect these 1/4" (unbalanced) outputs to connect to other pedals or directly to your guitar amp input. When connecting to a mono pedal or single amp, connect only the L/MONO 1/4" jack.
- 6. MIDI IN, OUT/THRU** Connect your MIDI gear to here to receive program changes, continuous controllers, MIDI Clock, and other MIDI messages. See ["MIDI" on page 49](#).
- 7. microSD** When you insert a 4 GB or larger microSD card into this slot, the Looper automatically uses the card's memory. This allows you to record a loop up to hours long, and retains your recorded loop even after you've powered DL4 MkII off.

! IMPORTANT! DL4 MKII requires that your microSD does not include any existing data (other than DL4 MkII Looper files), and be formatted with the FAT32 file system. See [" on page 19](#).
- 8. USB C** Connect to your Mac or Windows computer's USB port (USB 2.0 or higher) to use your MIDI software to control DL4 MkII's presets, parameters, tempo, and more. See ["MIDI" on page 49](#) for more information. The USB connection can also be used for any DL4 MkII firmware updates that may become available.
- 9. DC In** It is recommended to use the included Line 6 DC-1g AC adapter to power your DL4 MkII. The provided AC adapter serves as the power disconnect device.

Quick Start

Hooking It All Up

To follow we've provided several common setup examples for your DL4 MkII.

NOTE: DL4 MkII's Inputs and Outputs are Instrument Level.

Into Your Amp's Input

The simplest setup is to connect DL4 MkII in between your guitar output and amplifier input, as shown below. Optionally, you can connect other pedals in series, and DL4 MkII's form factor makes it quite pedalboard-friendly too.

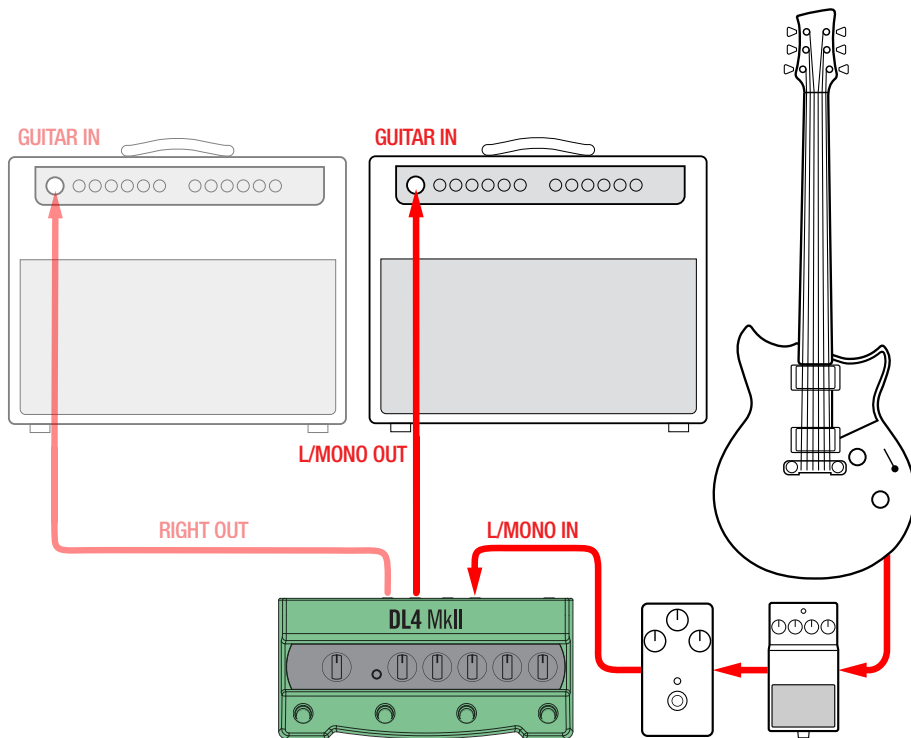

Into Your Amp's Effects Loop

When using an amplifier that includes an effects loop, it is often preferred to connect some effects (most often drives, distortions, wahs, and compressors) into the amp's front input (which places them before your amp's preamp), and time-based effects (like delays and reverbs) in the amp's effects loop. Placing DL4 MkII in your amp's effects loop can provide a smoother tone to the delay and reverb tails, especially with distorted tones.

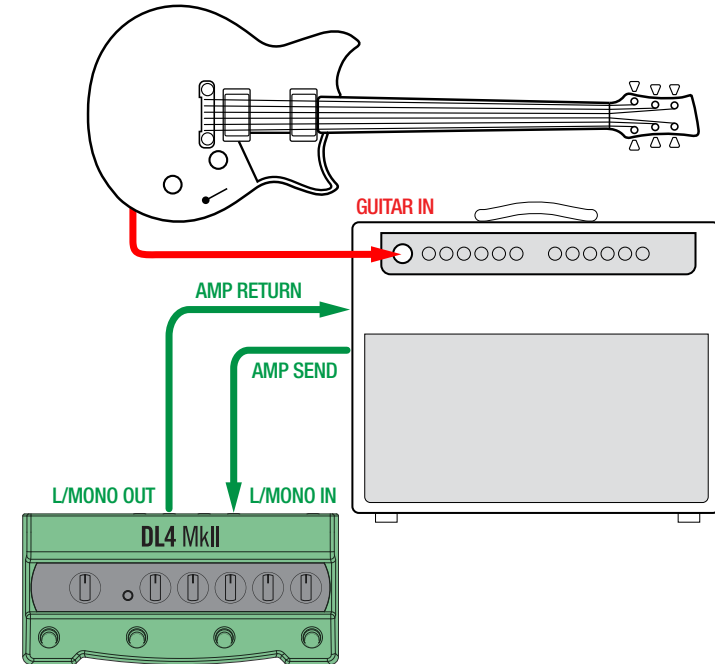

TIP: Optionally, you can also connect a MIDI 5-pin cable from the MIDI Out of another pedal or controller device into the DL4 MkII's MIDI In to control DL4 parameters, or to sync tempo via MIDI Clock — see ["Using MIDI Clock for Tempo Sync" on page 49](#).

DI into Mixer, Audio Interface, or Other Outboard Gear

There is no sense relegating DL4 MkII to your pedalboard! You can also put it into your signal chain when running D.I. into a mixer, audio interface, or other outboard gear to wreak havoc in other sonic domains. Connect your guitar, bass, or keyboard into the L/MONO IN. Or, connect your dynamic microphone into the XLR MIC IN. Then, run the output (L/MONO out for mono, or include the RIGHT OUT for stereo) directly into your line level device's inputs.

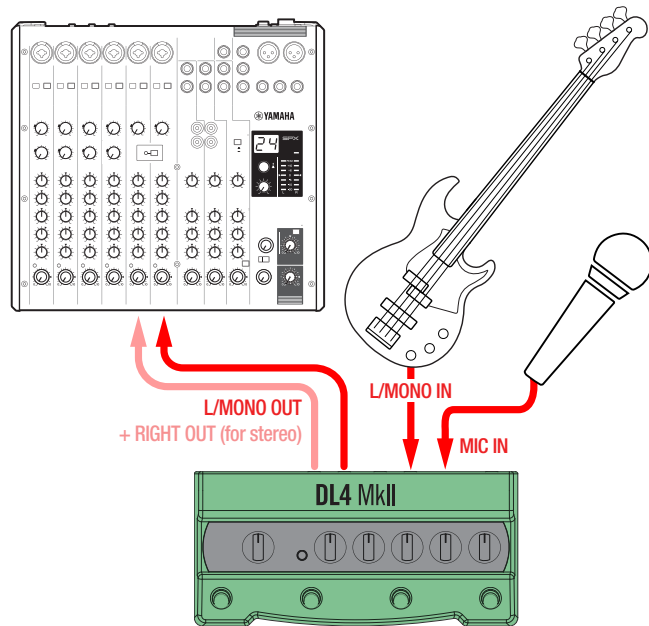

Using with a Modeler

If you happen to be using a modeler, such as a [Line 6 Helix®](#) or [HX®](#) device (or one from one of those *other* companies—we won't judge), and you've been wanting to squeeze even more tones out of it... You can now just patch DL4 MkII into the modeler's effects loop and let DL4 MkII handle the heavy lifting for your delay/reverb/looping. Optionally, you can also connect a "MIDI" cable to sync presets and/or tempi between the devices, and then run the whole rig out into a stereo amplifier (or even better, [Line 6 Powercab®](#) units!), for a super lean-and-mean setup. The following illustration shows you how.

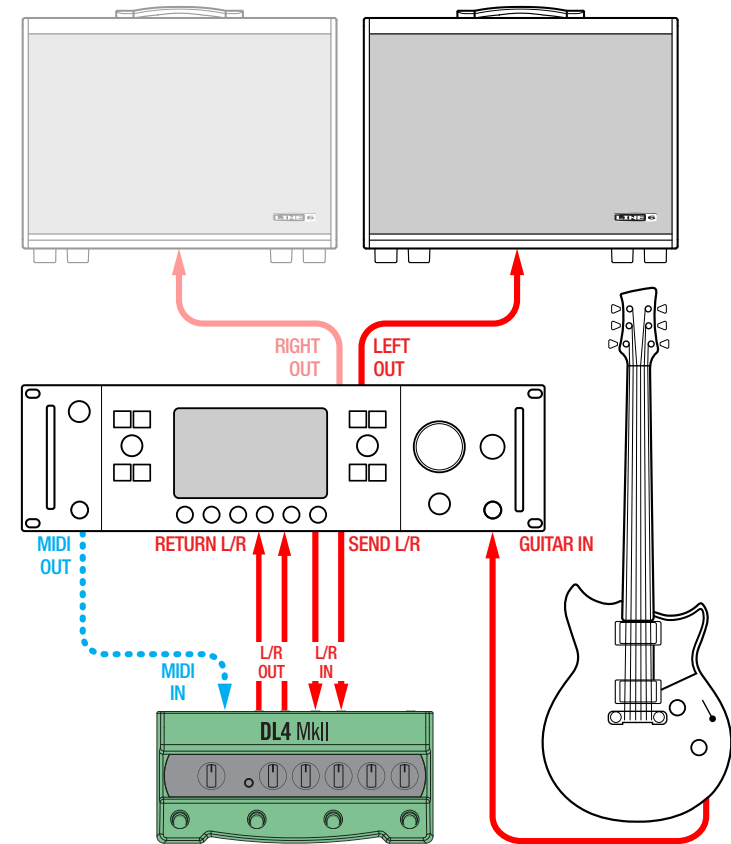

NOTE: If you're connecting to a modeler's mono FX Loop, you only need to connect the modeler's (mono) Send to the DL4 MkII L/MONO IN, and the modeler's (mono) Return to the DL4 MkII L/MONO OUT.

Basic Operation

Working with Presets

Being the clever operator you are, you've likely already deduced that you can simply press-release footswitch **A**, **B**, or **C** to toggle its respective preset between bypassed (lit dim green), versus active (lit bright green). We've pre-loaded these three locations with factory presets to get you started, which you can optionally replace with your own.



Figure 1: The A, B, and C switches indicate the Bypassed or Enabled state for the current preset

But there is more lurking below the surface... DL4 MkII includes an additional bank of three presets accessible from the device, as well as MIDI access to 128 presets individually!

NOTE: If you bypass the current preset and enable the same preset again, it remains in its edited state. If you load a *different* preset, your previously edited preset is recalled in its last-saved state the next time you stomp its footswitch to enable it again. In short—if you want to keep your modified preset settings, be sure to save it before loading another preset! See "[Saving a Preset](#)" on page 11.

Loading Presets A, B, and C

In its factory default state, DL4 MkII is set to access the Presets ABC Bank, which is pretty self-explanatory—toggling the **A**, **B**, or **C** labeled footswitch bypasses and enables preset A, B or C, respectively, as depicted above. These three preset locations come pre-loaded with factory presets to get you started, which you can modify as desired. To gain access to more presets, read on.

Loading Presets D, E, and F

In addition to the default bank of A, B, and C presets, also included is a second bank, which includes the D, E, and F presets, as well as 125 additional presets accessible strictly via MIDI that you can utilize for your own creations. These can be accessed as follows.

The Presets D, E, and F Bank

You can optionally re-purpose the **TAP** switch by choosing the **Presets DEF** Global Settings option—see "[TAP Footswitch Assign](#)" on page 44.* This allows you to toggle the device's **A**, **B**, and **C** labelled footswitches to access the default, first Presets ABC Bank (**TAP** is lit dim yellow) versus the second Presets DEF Bank (**TAP** is lit bright yellow). We've also pre-loaded the D, E, and F locations with factory presets, which you can optionally modify.

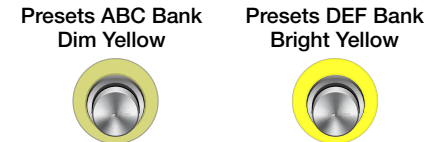

Figure 2: The TAP footswitch, when configured, selects and indicates the current preset bank

***TIP:** If you don't want to contemplate life without a dedicated TAP Tempo switch, you can optionally connect a footswitch to **FS 5/6** and configure its "[Global Settings](#)" for **TAP**.

Loading Presets 1 - 128 via MIDI

As covered in the preceding sections, the first six presets are arranged in banks of three (A,B,C and D, E, F), and can be accessed via DL4 MkII's footswitches. Alternatively, these first six presets can also be accessed individually by sending MIDI Program Change messages 000 through 005, respectively, to DL4 MkII.

The additional presets, 7 through 128, are not accessible from the DL4 MkII footswitches, but are accessed individually, strictly via MIDI Program Change messages 006 through 127. Please also see "[" on page 49](#)."

Note that, once you recall any preset via MIDI, its delegated DL4 MkII footswitch will light up, allowing you to toggle its bypass, or press and hold the footswitch to save your settings to the preset location. However, the current preset bank in use on DL4 MkII is not changed by MIDI preset loading. Thus, if you've configured the **TAP** switch for the (yellow) **Presets DEF** bank select option, note that pressing any *unlit* **A**, **B**, or **C** labelled DL4 MkII footswitch will still select the respective preset within the current bank, indicated by the TAP switch's dim yellow (Presets ABC Bank) or bright yellow (Presets DEF Bank) state, as shown in Figure 2 above.

Saving a Preset

When you see current preset footswitch's LED flashing approximately once every two seconds, this tells you that your loaded preset is edited from its last-saved state. Once you dial in that magical combination of settings, it's a great idea to **save** them to your current preset location. Saving captures the current delay and reverb, all knob settings, tempo, and any existing expression pedal or external footswitch parameter assignments. If you'd like to save your current settings, press and hold the currently-lit **A**, **B**, or **C** footswitch for three to four seconds until you see its green light flash four times rapidly, then release and your preset is saved, replacing the preset that previously occupied this slot.

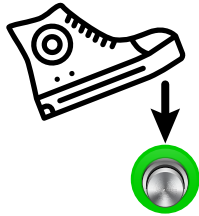

Press and hold the currently lit A, B, or C footswitch to save

Note that by performing the press-and-hold as described above, you'll always be saving to the specific preset location for the **currently loaded preset**. For example, if switch **A** is currently lit:

- When your footswitches are controlling the default presets A, B, and C bank (Global Settings - "Presets ABC" is selected), then press-hold switch **A** saves to the preset A location.
- When your footswitches are controlling the presets D, E, and F bank (Global Settings - "Presets DEF" is selected), then press-hold switch **A** saves to the preset D location.
- When you've recalled a preset via MIDI Program Change, the presets 1 through 128 are mapped to the A, B, C footswitches sequentially. Therefore, when loading preset 7 (via MIDI Program Change 006), you'll see switch **A** lit, for preset 8, you'll see switch **B** lit, for preset 10, you'll see switch **A** lit, etc.

Saved Parameter Value Indicator

When turning any of DL4 MkII's six knobs to edit your preset's selected delay model or parameters (or when holding ALT/LEGACY and turning knobs to edit your reverb model or parameters), you'll see the ALT/LEGACY button's LED temporarily light up bright white at specific locations on the knob. When you see this white LED, it indicates this as the parameter's value that is saved in the current preset. This makes it easy to tell which delay or reverb model, or to what value each knob is saved for the current preset. Note that you'll need to turn the knob fairly slowly to see where the LED lights up—and it will remain lit white only for a few seconds before returning to its previous state.

Hit the Trails?

One rather important consideration is how to configure the behavior for **Trails** (the repeats of your delay and decay of your reverb) when you bypass your preset. This option can be changed within the Global Settings—see ["Bypass Trails" on page 47](#).

Off - (The factory default setting) Bypassing your active preset abruptly silences the delay and reverb trails.

On - Your delay and reverb trails decay naturally once the preset is bypassed.

Your delay and reverb trails for the current preset are always silenced once you activate another preset, regardless of the Trails setting. The type of bypass you choose can be a sonic factor for your trails as well—see the next section.

What Type of Bypass?

When you bypass a preset, you're actually bypassing the entire DL4 MkII device, so a few decisions are in order for exactly how you prefer things to behave. You can choose one of the following options within the device's Global Settings > ["Bypass Type"](#)

True Bypass - Your input signal is sent directly through DL4 MkII with no A/D/A (Analog to Digital to Analog) conversion and all DSP is bypassed. This means that all Trails (if "On"), Looper playback, and the MIC IN are muted when you bypass the current preset.

NOTE: For the following three options, we're describing the audible behaviors assuming you have **Bypass Trails** set to **On** (see preceding section). If Trails is **Off**, you'll not hear any trails, regardless of the **Bypass Type** selected.

Buffered Bypass - (The factory default) Your input signal continues to be sent directly through DL4 MkII with no A/D/A conversion, its signal to the DSP is muted, and the DSP's existing delay and reverb trails are allowed to decay naturally.

DSP Bypass - Your input is sent through the DSP path, along the delay and reverb, but any further delay processing is bypassed. The DSP's existing trails decay naturally.

Dry Kill - Your input is completely muted, but any existing DSP's trails decay naturally. This behavior is akin to muting a mixer or effects loop send to a rack processor while the effects return is still active.

TIP: You can still tap in a tempo using your **TAP** (or other Tap-assigned) switch when DL4 MkII is bypassed. (You couldn't do that on the original DL4, so there's something to gloat about at that next after-gig party.)

Restoring Factory Presets

DL4 MkII is pre-programmed with a set of great factory presets at birth, containing six unique settings within the presets A~F locations. The MIDI-accessible preset locations, 7~128, include a common preset, which differs from the six A~F factory presets (also, see [" on page 16](#)). All factory presets are over-written with your custom settings whenever you perform a preset save. Should you ever wish to restore the factory presets—and **erase the sounds you might have saved in any of the 128 preset locations**—you can perform a Factory Restore.

1. **Press and hold both the A and TAP footswitches while connecting the power adapter to the DC IN.**
2. **Continue to hold the switches for approximately 8 seconds, until you see the green LEDs light up.**

Your DL4 MkII device is restored with all factory presets and original default global settings.

About Tap Tempo

As you’ve likely surmised by now, you can set a tempo on your DL4 MkII simply by "tapping" on the TAP footswitch rhythmically a few times—you’ll see the TAP light flash to indicate the current tempo. But you may be wondering what all this fuss is about "Tap Tempo" and "Note Subdivisions," and why you might want to use them.

In the early days, when tape and mechanical echo units first roamed the Earth, engineers in lab coats had to manually calculate the correct delay time for the tempo of a song by dividing 60,000 into the tempo to determine the 1/4 note delay value. From there they could calculate all of the wonderful possible rhythmic subdivisions, using a multiplier table like this:

1/4 Note Delay Time Multiplier Table			
Note Value	Multiplier	Note Value	Multiplier
Whole Note	4	Dotted 1/8	.75
Dotted 1/2	3	1/8 Note	.5
1/2 Note	2	Triplet 1/8	.333
Triplet 1/2	1.333	Dotted 1/16	.375
Dotted 1/4	1.5	1/16 Note	.25
1/4 Note	1	Triplet 1/16	.167
Triplet 1/4	.667		

When slathering your signal with spacious delay, it is often most pleasing to hear those repeats in sync with the song’s tempo—and perhaps at a specified note value subdivision (like the ubiquitous dotted 1/8th note salvo employed by The Edge).

Fortunately, no calculators or math are required with DL4 MkII. By default, all delay models are configured so that you’ll see the TAP switch’s LED flashing at 1/4 note subdivisions of the current Tap Tempo. If you stomp several times on the TAP switch, counting in 1/4 notes, this changes the current Tap Tempo and your repeats dutifully follow. When you change to a different delay model, you’ll see the tempo changes to the new model’s default delay time (unless you’ve set a note subdivision, or changed to the Global Tempo option—see the following sections for all about those topics).

Note Subdivisions

To change to a different note subdivision of the tempo, press-hold the ALT/LEGACY button while turning the TIME/SUBDIV knob to the selected note value on the knob label.

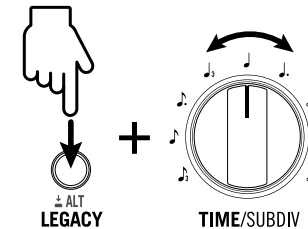

Press-hold ALT/LEGACY button and turn TIME/SUBDIV knob to choose a note subdivision

The red TAP light continues to flash at the 1/4 note of the current Tap Tempo for reference, but you’ll hear your delay repeats at the selected subdivision of the current tempo. Once you’ve set a note subdivision, your specific tempo and selected note subdivision will not change when selecting a different a different delay model within your current preset.

If you prefer to just return to just setting your tempo "by ear," simply turn the TIME/SUBDIV knob (without touching the LEGACY button) to exit the "note subdivision mode" and adjust your delay time manually. The red TAP light returns to flashing at 1/4 notes of your new tempo rate for reference.

Per Preset or Global Tempo

By default, the current Tap Tempo is stored and recalled individually **Per Preset**. If you prefer, you can change this behavior to **Global**, by way of the Global Settings > ["Tempo Preset/Global"](#) option, so that your Tap Tempo remains unfettered across preset changes, until you change it again manually.

Configuring Delay and Reverb Routing

Maybe this has kept you up at night pondering—is it better to "delay" your reverbs, "reverb" your delays, or neither? If delay follows reverb, the reverb's tail will have distinct echoes applied. If reverb follows delay, the delay's echoes will have a schmeer of reverb administered. Conversely, if the reverb and delay are on separate parallel paths, they won't affect one another, resulting in cleaner, more defined notes. Exploit these options as follows—your routing is saved and recalled individually, per preset (also see "" on page 26).

NOTE: No matter which of these routing options you choose, it never affects the stereo aspect of your signal—all delays and reverbs process in stereo. See the next section.

To Set the Reverb before the Delay - Press-hold the ALT/LEGACY button and turn TWEEZ to minimum.

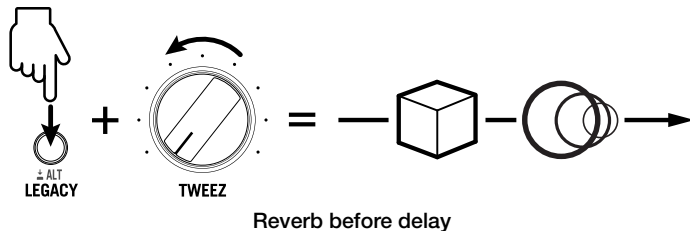

To Set the Delay and Reverb in Parallel - Press-hold the ALT/LEGACY button and turn TWEEZ to 50%.

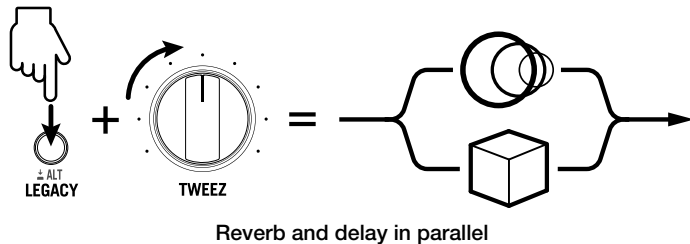

To Set the Reverb after the Delay - Press-hold the ALT/LEGACY button and turn TWEEZ to maximum.

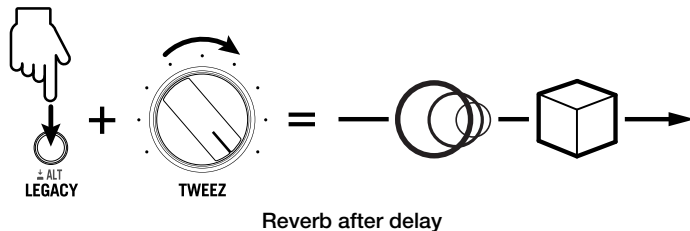

Stereo vs. Mono Output

For those of you that care to know about such details... Many models included on your DL4 MkII create a wide, wonderful stereo effect when you've connected both the L/MONO and RIGHT 1/4" outputs to a stereo amplifier setup or monitoring system. Here's the deal:

- If you connect a single, mono source into the L/MONO (or MIC IN), the source is fed into DL4 MkII's left and right audio channels and processed by these effects in stereo. As long as you utilize both the L/MONO and RIGHT outs, you'll hear all your DL4 MkII effects in stereo.
- If you connect a stereo sound source into the L/MONO and RIGHT inputs, the left and right sound sources are processed discretely, keeping your stereo signal intact throughout DL4 MkII's entire circuit (assuming you are also utilizing both the L/MONO and RIGHT outputs).

But the above then begs the question—what happens to these stereo effects when you're using only DL4 MkII's single L/MONO output? The answer is that the result is always going to be mono. DL4 MkII treats some stereo effects differently than others to provide the best sonic results in mono:

- The Harmony Delay, Stereo Delay, Dual Delay, Euclidian Delay, Crisscross, Ping Pong, and Multi Pass models all create distinct left and right echo outputs in stereo. Therefore, for these delay models we ever so gently fold both signals down to mono so you don't miss out on any of those coveted repeats.
- The models that include modulation typically have some left/right offset sweep for a widening impression. But folding these models' modulation down to a mono output can result in phasing or other irksome artifacts. Therefore, in most cases, DL4 MkII passes along only the left channel of these models as your mono signal for the most satisfying results.

NOTE: In the odd case where you might be connecting a stereo source into both DL4 MkII's LEFT and RIGHT inputs, but only using the L/MONO output, then some effects just aren't going to include your right input signal at all. The moral of the story here is, if you're wanting full stereo throughput in and out of DL4 MkII, you should utilize both the L/MONO and RIGHT outputs.

- The Classic Looper, as well as the 1 Switch Looper, can be configured as mono or stereo—see Global Settings - "[Setting the Looper to Mono vs. Stereo](#)" on [page 20](#). The factory default Looper setting is Stereo. Therefore, if you are using both the L/MONO and RIGHT inputs to feed a stereo signal into DL4 MkII, you'll want to keep the current Stereo setting to record and play back your loops that way.

Setting up an Expression Pedal and Footswitches

You can connect an expression pedal for dutiful foot control of one or more effect parameters while your hands are busy making music (or whatever your hands are busy doing—we don't care to know). Optionally, connect a footswitch (or two!) to toggle DL4 MkII's "Footswitch 5" and/or "Footswitch 6" selectable options. Note that it is also required that you adjust the device's Global Settings options for your specific pedal/footswitch configuration, as indicated within the following examples.

NOTE: You'll need to purchase an expression pedal and footswitch(es) separately to use with DL4 MkII:
The Line 6 EXP-1 pedal is a fine choice, or most 3rd party expression pedals will work as well.
For single or dual external footswitches, you'll want to get the "momentary" (unlatched) type.

It is possible to configure your expression pedal and/or footswitch(es) to control numerous parameters simultaneously for the preset's **current** delay and reverb model, and your assignments are stored with the current preset once you save it. Just remember that when you change the delay or reverb model within the preset, all existing assignments are cleared (and gone permanently if you then save the preset). The best practice is to load your preset, choose your preferred delay and reverb models and their settings, then perform the steps to configure your preferred delay and/or reverb parameter pedal or footswitch assignments, as provided in the following sections.

TS versus TRS Cable Types

First things first... In case you are not already familiar, you'll want to be able to identify the difference between these two types of 1/4" cable connections for your expression pedal or footswitches for our examples in this section:

- A Tip-Sleeve (TS) type cable consists of two conductors, the Tip (positive) and Sleeve (ground).
- A Tip-Ring-Sleeve (TRS) type cable consists of three conductors: the Tip (positive 1), Ring (positive 2), and Sleeve (common ground).

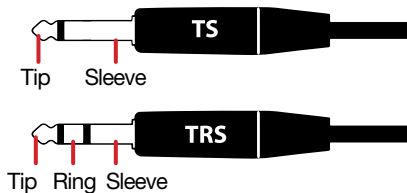

The EXP PEDAL jack on the rear of DL4 MkII is a TRS type jack, into which you can connect a single expression pedal or single footswitch using a TS cable, or a dual-footswitch using a TRS cable. It is also possible to connect an expression pedal with a TS cable and a footswitch with a TS simultaneously, provided you connect them into a dual TS-to-TRS splitter (or "Y" adapter). Please see the following hookup examples.

IMPORTANT! To avoid potentially triggering signals that could get loud through your amplifier or monitoring system, please reduce your volume before connecting anything into the DL4 MkII EXP PEDAL jack, and be sure to configure the Global Settings > "Pedal Jack Functionality" to the settings recommended in the following examples to match your specific setup.

Connecting an Expression Pedal

If you're connecting only an expression pedal, use a TS instrument cable and plug into the EXP PEDAL jack.

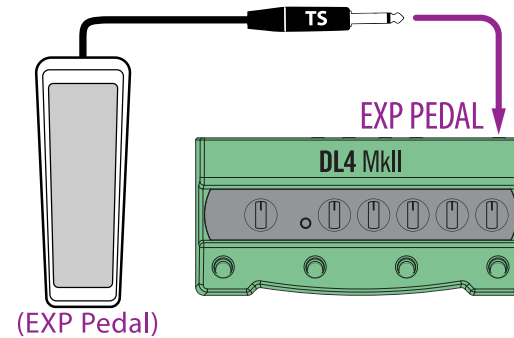

Connecting an expression pedal (TS cable connection)

For this expression pedal connection, you'll want to keep Global Settings > "Pedal Jack Functionality" on the default **EXP Pedal Only** option. To put your pedal to use, skip to "Configuring One or More Parameters for Pedal Control" on page 15.

Connecting a Single Footswitch

If you're connecting only a single footswitch, including the typical affixed TS cable, you can plug it into the EXP PEDAL jack.

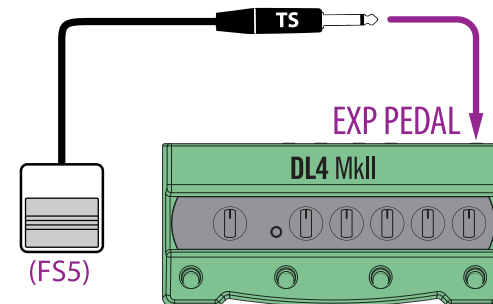

Connecting a single footswitch (TS cable connection)

For this type of single footswitch-TS connection, you'll need to change the Global Settings > "Pedal Jack Functionality" to the **Single Footswitch** option—The footswitch is then able to control the **FS5** function. To choose a different FS5 function, see "" on page 16.

Connecting an Expression Pedal and Footswitch

For this setup, use a dual TS-to-TRS splitter and plug into the EXP PEDAL jack. Your expression pedal should connect to the "Tip" and the footswitch to the "Ring" leads of the splitter.

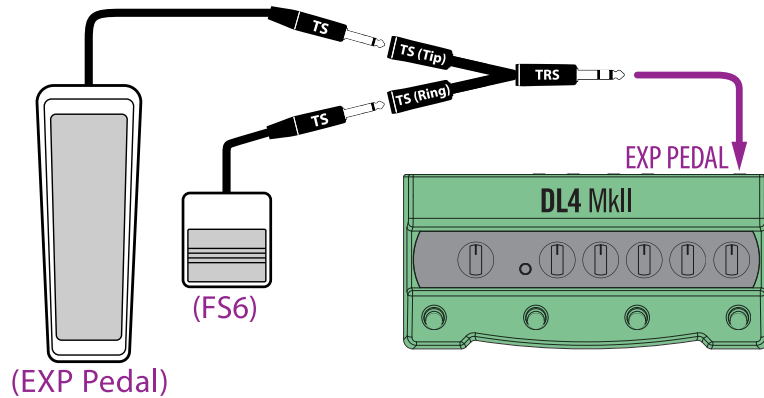

Connecting an expression pedal and footswitch (dual TS-to-TRS splitter connection)

You'll need to set the Global Settings > ["Pedal Jack Functionality"](#) to the **EXP Pedal + Footswitch** option. To put your pedal to use, see ["Configuring One or More Parameters for Pedal Control"](#) on page 15. The footswitch controls FS6 which, by default, triggers the "Squeal" delay repeats option—to change your footswitch's FS6 function, see [" on page 16.](#)

Connecting Two Footswitches

You can achieve this type of setup using either a dual-footswitch unit (which typically utilizes a TRS cable) or two individual footswitches (each of which typically utilizes a TS cable).

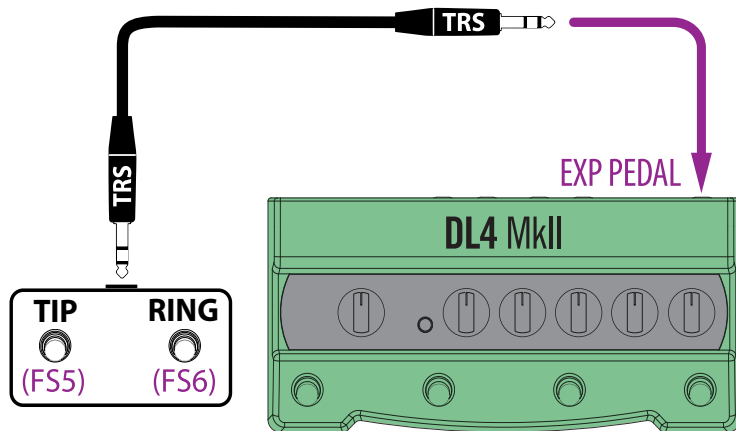

Connecting a dual-footswitch (TRS - TRS connection)

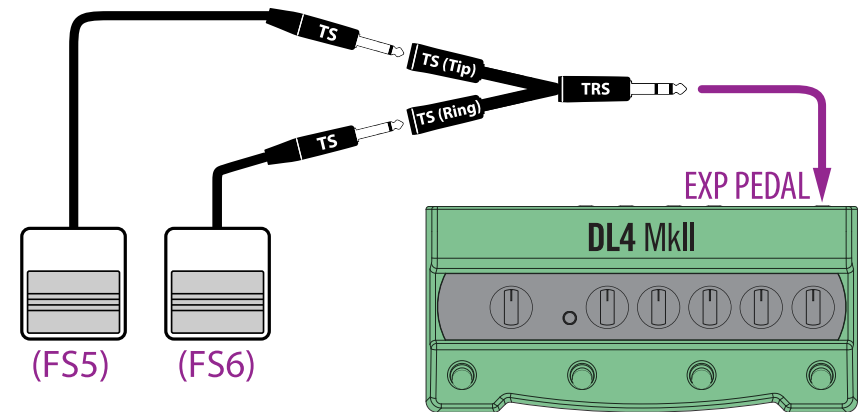

Connecting two individual footswitches (dual TS-to-TRS splitter connection)

For either of these footswitch connections, you'll need to configure Global Settings > ["Pedal Jack Functionality"](#) to the **Two Footswitches** option. By default, FS5 is set for "Expression Toggle" and FS6 for the "Squeal" delay repeats option—to change these functions, see [" on page 16.](#)

Configuring One or More Parameters for Pedal Control

TIP: The A~F factory presets already include pre-assigned parameters for an expression pedal—see [" on page 16.](#)

To create your own pedal assignments, operation is designed to be simple. For the following example, we'll configure the MIX knob for the current delay model of preset A to be controlled by an expression pedal.

1. **Load any preset on DL4 MkII, preferably one you're OK with editing and saving with your new changes.**
2. **Change the delay and/or reverb model and adjust their settings to your liking.**

Changing the models removes any existing pedal and footswitch assignments, and provides you with a clean start for creating your new assignments. (Optionally, you can leave the preset's models and your new assignments will be created in addition to any existing ones.)

3. **Plug your expression pedal into the EXP PEDAL jack.**
See the preceding illustrations for how to connect your pedal.
4. **Move your expression pedal to the full heel-down position.**

5. Turn the MIX knob to a very low setting.

This new MIX knob setting is stored for the pedal's minimum, heel-down value.

 **NOTE:** Optionally, you can adjust other parameters for the current delay to the pedal as well before proceeding to the next step. Just like with MIX, any knob you adjust—and the value you choose—will be assigned to the heel-down position of the pedal.

Remember that you are not limited to just controlling delay parameters—you can also press-hold the LEGACY button and turn the desired knobs to assign the current reverb effect's parameters!

6. Move your expression pedal forward to the fully toe-down position, and set the MIX knob to 50%.

This new MIX knob setting is stored for the pedal's maximum, toe-down value.

 **NOTE:** If you assigned additional parameters in the previous step, also adjust each to the value you wish to be assigned to the pedal's toe-down position.

7. Rock your expression pedal back and forth and you'll hear the MIX (and any additional assigned parameters) adjust accordingly.

Don't change your current delay or reverb model once you've created your pedal assignments—doing so will clear your assignments on each. (Of course, if you *want* to clear your assignments, you can change the models and go back to step 4.)

 **NOTE:** If your expression pedal happens to control parameters in the reverse direction, change the Global Settings > "[EXP/Switch Polarity](#)" option to **Inverted**.

8. Save the preset to store your new expression pedal assignment (see "[Saving a Preset](#)" on page 11).

Your pedal-assigned parameter(s) will be recalled at the specific values at which they are set when you save the preset.

 **TIP:** Once your pedal assignment(s) are configured for your preset, note that you can optionally connect a single footswitch in place of the expression pedal (via a TS cable), change the Global Settings > "[Pedal Jack Functionality](#)" to the **Footswitch Only** option and the footswitch will toggle the expression pedal-assigned parameters' min. and max. values!

Factory Presets - Existing Expression Pedal Assignments

The following expression pedal assignments are already configured within factory presets A~F. Just connect your pedal and give them a try!

 **TIP:** In most of the presets, where the expression pedal is set to control the delay's REPEATS, pushing your pedal to the maximum toe position will send the delay into "squeal" with infinite, runaway repeats!

Factory Presets: Models & Expression Pedal Assignments

Preset A: Adriatic Delay and Ganymede Reverb	
Pedal Assignments	Delay TIME, REPEATS, and TWEEZ (modulation depth)
Preset B: Cosmos Echo and Plate Reverb	
Pedal Assignments	Delay REPEATS and TWEEZ (wow & flutter)
Preset C: Multi-Pass Delay and Searchlights Reverb	
Pedal Assignments	Delay REPEATS and MIX
Preset D: Vintage Digital Delay and Hall Reverb	
Pedal Assignments	Delay REPEATS, FEEDBACK, and TWEAK (sample rate and bit depth)
Preset E: Glitch Delay and Particle Verb Reverb	
Pedal Assignments	Delay REPEATS, TWEAK (pitch), and TWEEZ (slice feedback, sequence drift, and shuffle)
Preset F: Transistor Tape Delay and Hot Springs Reverb	
Pedal Assignments	Delay TIME, REPEATS, and TWEEZ (wow and flutter)
Presets 7~128 (via MIDI*): Ping Pong Delay and Double Tank Reverb	
Pedal Assignments	None

*The **Preset 7~128** locations are accessible only via MIDI—see "[" on page 49](#).

 **NOTE:** Factory presets A~F each have a Reverb model loaded, as indicated in the above table, but with the Reverb - Mix set at 0% (dry). Hold ALT/LEGACY and turn the MIX knob to blend in some reverb to taste!

Configuring Footswitch Control Options

Your footswitches can be set up to each control the desired function by managing their Global Settings, as follows.

1. **Choose the preferred footswitch function for each, as described within the Global Settings table (Tap Tempo, Looper Mode, Expression Toggle, or Squelch).**

NOTE: The **TAP** footswitch offers the option to control the **1 Switch Looper** (see ["Using the 1 Switch Looper" on page 23](#)), and external footswitches 5 and 6 offer the option to enter/exit the Classic Looper mode.

The **TAP** footswitch also offers the additional option to control the **Presets DEF** bank (see ["Loading Presets D, E, and F" on page 10](#)).

- For the on-board **TAP** footswitch, go to the ["TAP Footswitch Assign"](#) option. The Factory default setting is **TAP Tempo**.
 - For **Footswitch 5**, go to the ["Footswitch 5 Assign"](#) option. The factory default setting is **Expression Toggle**.
 - For **Footswitch 6**, go to the ["Footswitch 6 Assign"](#) option. The factory default setting is **Squelch**.
2. **If choosing Expression Toggle, you can then configure the footswitch to control any parameter (or multiple parameters) per preset—much like is possible with an expression pedal, where the switch toggles between your two defined parameter values.**

To configure an Expression Toggle footswitch:

- Load a saved preset and choose the desired delay and reverb models and their settings.
- Press and release the footswitch once.
- Turn a DL4 MkII knob to the desired setting (for example, turn the MIX knob to a low value).
- Press and release the footswitch once again.
- Turn the same DL4 MkII knob to a different value (turn the MIX knob to a higher value).
- Optionally, repeat the above previous four steps on the current preset to assign another parameter for simultaneous control.
- Now when you toggle the Expression Toggle switch, it will toggle the current delay model's mix level (as well as any other configured parameter) between the two set values.
- Save the preset to retain your footswitch assignments (see ["Saving a Preset" on page 11](#)). You can repeat the steps on the same preset to update them to a different parameter—and configure other presets as well.

Controlling The Classic Looper Parameters

There is even more control to be had with your expression pedal and footswitches—you can also configure them to control the Classic Looper mode parameters. This allows you to perform feats such as manipulating the Looper's built-in echo parameters and the loop playback volume, all while actively using the Classic Looper!

TIP: If not yet familiar, it would probably be a good idea to read up on the Classic Looper before jumping into the following steps—see ["Using the Looper" on page 19](#).

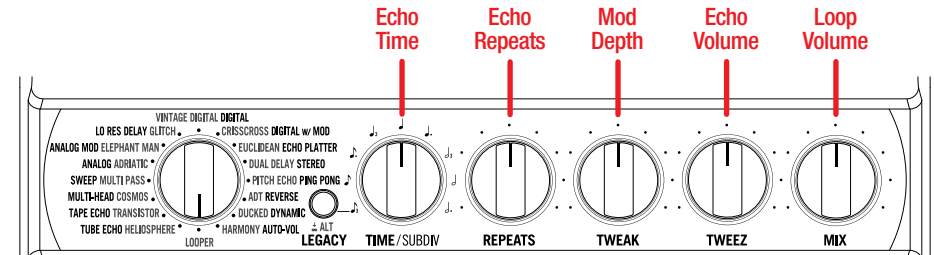

Functions of knobs while in Classic Looper mode

1. **Set the DL4 MkII's Selector knob to LOOPER to enter the Classic Looper mode.**
2. **With your expression pedal and/or footswitches connected, you can create an assignment to any (or more than one, for simultaneous control) of the Looper mode's TIME, REPEATS, TWEAK, TWEEZ, or MIX knobs.**

For creating expression pedal assignments to these knobs, see ["Configuring One or More Parameters for Pedal Control" on page 15](#).

For creating footswitch assignments to these knobs, see [" on page 16](#).

Once you've create pedal or footswitch assignments to these knobs, your assignments remain intact whenever you come back to the Classic Looper mode from any preset, and even after you've powered DL4 MkII off and back on again!

Using a Microphone

Yet another new addition to the DL4 MkII incarnation is the inclusion of a Mic input. This opens up a new world of possibilities for your new little green box! Not only can you now embellish your verses, choruses, and poetry readings, but imagine the potential looping creations with acoustic instruments and other mic'd up sources.

Connect your dynamic microphone into the XLR MIC IN jack and use the LEVEL trim knob to adjust the built-in preamp's input gain to optimize your signal.* If your Mic input signal is too hot, you'll see the ALT/LEGACY button light up red to indicate clipping—at which point you should apologize profusely, and turn the LEVEL knob to the left to reduce your input and avoid that nasty input distortion.

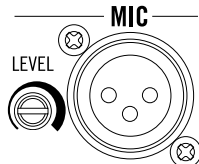

Use the **LEVEL** trim knob to adjust the mic input level



ALT
LEGACY

The **ALT/LEGACY** button lights red to indicate clipping

*NOTES:

The MIC IN does not include phantom power. If you're wanting to use a mic that requires phantom power, you'll need to first connect to a separate mic preamp or other unit that provides power to your mic, and then feed the audio signal into the DL4 MkII MIC IN.

The MIC IN preamp circuit requires DSP power to do its thing, so you'll need to avoid setting Global Settings > "Bypass Type" to the **True Bypass** option, which mutes the MIC IN. (By default, DL4 MkII is set to the **Buffered Bypass** option, so the MIC IN all works just dandy if you haven't messed with the Global Settings yet.)

Using the Looper

One of the coolest and most beloved features of the classic DL4 was its built-in "Loop Sampler," and indeed one of the reasons you still see that big, road-worn green box on so many players' pedalboards to this day! We've not only included all the features and fun of the original Loop Sampler, but we've also expanded loop times, added a microSD card slot for huge recording capacity, and even appended a new, simple 1 Switch Looper. We also changed the name to just "Looper" for simplicity (and because "Loop Sampler" is, well... so 1999).

The Looper offers up to 240 seconds of recording time in the internal memory, depending on your settings (see the table below).*

 ***NOTE:** Optionally, you can insert a **microSD** card—which increases the loop record time to hours! See [" " on page 19](#).

Model	Max. Loop Length	
	Half Speed	Full Speed
Looper (Mono)	240 seconds	120 seconds
1 Switch Looper (Mono)	N/A	120 seconds
Looper (Stereo)	120 seconds	60 seconds
1 Switch Looper (Stereo)	N/A	60 seconds

“Should I Use the Classic Looper or the 1 Switch Looper?”

Good question! There is only one Looper “mechanism” within DL4 MkII, but you can utilize either the Classic Looper Mode or the 1 Switch Looper as the interface to access it. Use either to record your loop to memory, and the loop remains in memory until you choose to delete it, or until you power DL4 MkII off. You can then use either the Classic Looper mode or the 1 Switch Looper to play/stop the loop, add overdubs, and more. See the handy tutorials within this chapter for details. Using the Classic or 1 Switch Looper each has its advantages—summarized as follows.

Classic Looper

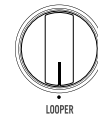

Turn the device's Selector knob to LOOPER. (Note that the ALT/LEGACY button always remains unlit when the LOOPER is selected.) This essentially places all the devices' knobs and footswitches over to a dedicated Looper mode, where they control Looper-specific functions and parameters. You'll see the LED for the Play/Stop ►/■ switch appear lit dim green to indicate when a loop is in memory.

When using the Classic Looper, one advantage is that you have the convenient, dedicated footswitches (and their LED indicators) to control Record/Overdub, Play/Stop, Play Once, 1/2 Speed, and Reverse. The Looper mode also includes a simple and effective, built-in echo effect that is controlled via the device's knobs (although, you won't hear any of your presets' MkII/Legacy delay and reverb effects applied to your input signal while within the Classic Looper mode).

 **TIP:** You can actually start out recording your loop using the Classic Looper and start playback, and then turn the Selector knob to switch out of the Classic Looper mode and your loop playback continues uninterrupted! This is a nice option if you want to exit Looper mode to load a preset with your preferred delay and reverb and have the effects applied to your input signal while jamming along. Just remember that you'll need to switch back into Classic Looper mode to stop loop playback (unless you've configured the TAP switch to access the 1 Switch Looper, in which case you can use the TAP switch stop and control your loop.

1 Switch Looper

 **TAP** To access the 1 Switch Looper, you'll need to configure the Global Settings > ["TAP Footswitch Assign"](#) to control the 1 Switch Looper. You can use the 1 Switch Looper to record or access a recorded loop while **not** in Classic Looper mode. You'll see the TAP switch's LED lit bright white to indicate when a loop is in memory.

The advantages of using the 1 Switch Looper are (since you are not in the dedicated Classic Looper mode) the current preset's delay and reverb effects are applied to your input signal, and you can continue to tweak the effects' settings. Having all Looper controls available on the one (TAP) switch also makes looping fast and simple (albeit without the added controls offered within the Classic Looper mode, such as dedicated playback level control, 1/2 Speed, and Reverse functions).

 **TIP:** You can actually start out recording your loop using the 1 Switch Looper and start playback, and then turn the Selector knob to switch into the Classic Looper mode and your loop playback continues uninterrupted! This is a nice option if you want to utilize the Classic Looper's enhanced switching and playback options.

Using a microSD Card



Once a microSD card is initially formatted for use with DL4 MkII (see next section), when you insert the card into the **microSD** slot on the rear of DL4 MkII, the Classic and 1 Switch Looper automatically use the card instead of the internal device memory for loop recording and playback, offering you greatly extend recording time for your loop masterpieces!

Preparing your microSD Card for Use with DL4 MkII

The microSD card must be either the SDHC or SDXC type, 4 GB or larger capacity, and initially formatted by DL4 MkII before it is functional with the Looper. Once formatted, your card must include no other existing files on it (other than DL4 MkII's own Looper-created data). The best idea is to just purchase or dedicate a microSD card exclusively for DL4 MkII use (and, since the Looper will only ever utilize 4 GB, it's not necessary to use a large capacity card). The process for doing the initial format of your microSD card is as follows.

IMPORTANT! The following process will permanently erase any files you may have stored on your microSD card.

1. **Power on and turn your DL4 MkII's Selector knob to LOOPER. Be sure the Looper is stopped (not actively recording or playing a loop).**
2. **Press and hold the ALT/LEGACY button while inserting your microSD card into the slot on the back of DL4 MkII.**

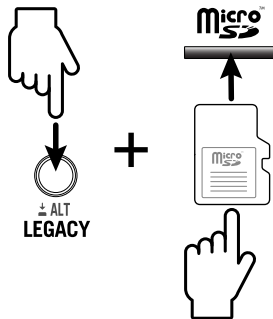

3. **Once the card is fully seated in the slot, release the ALT/LEGACY button when you see its LED start flashing through different colors. DO NOT power off or touch any controls on DL4 MkII while you see the LED flashing, which lasts only a few seconds.**
4. **When the ALT/LEGACY button's LED stops flashing, the formatting process is complete. You can then use your microSD card with the Classic Looper or 1 Switch Looper!**

To remove the microSD card, **push the card inward** to trigger the spring-loaded mechanism and the card will be ejected from the slot. When no microSD card is present in the DL4 MkII device, the internal memory is utilized for loop recording and playback.

IMPORTANT! To avoid loss of your recorded loop or potential damage to your card, do not eject the microSD card from DL4 MkII during looper recording or playback.

The big advantage to using a microSD card is that your loop recording memory is expanded to several GB of space, which allows you to record a loop that is a few hours in length (or even longer with the Looper set to mono)! Another benefit is that, unlike when recording your loop to the DL4 MkII internal memory, your last recorded loop remains accessible on the card—even after the card has been ejected or the device powered off. Just reinsert the microSD card and you'll see the ►/■ looper switch lit dim green when in the Classic Looper mode (or your TAP switch LED lit bright white when using the 1 Switch Looper), indicating your loop is there and ready to play.

Setting the Looper to Mono vs. Stereo

Go to Global Settings > "[Looper Mono/Stereo](#)" on page 46 to configure option to **Mono** or **Stereo** (the factory default). This option affects both the Classic Looper and 1 Switch Looper. As you can see in the Looper Record Time table at the start of this chapter, when set to Mono, this effectively doubles the loop recording time capacity. The trade-off, however, is that if you happen to be utilizing both the L/MONO and RIGHT inputs on DL4 MkII to input a stereo signal, the Looper will sum these inputs and your recorded loop will be folded down to mono.*

***NOTE:** Mono and stereo behaviors also depend upon whether you are using both the device's the Left and Right Input and Output jacks—see "[Looper Mono/Stereo](#)" on page 46 for the full details.

Configuring the Looper Pre/Post Effects

You'll probably want to consider your preferred option for the "[Looper Pre/Post Position](#)" global setting, since this affects the behavior of the loop recording and playback with respect to your delay and reverb effects. This Pre/Post setting affects both the Classic Looper and 1 Switch Looper.

NOTE: The Looper Pre/Post setting can also impact the Looper Mono/Stereo global setting—see "[Looper Mono/Stereo](#)" on page 46 for details.

- **Looper "Pre"** positions the Looper before the built-in echo (in Classic Looper mode), or delay/reverb models (when using the 1 Switch Looper), which means that you'll hear effects repeats applied to your input signal and to the playback of your recorded loops, but the effects are not captured within your loop recordings.
- **Looper "Post"** (the factory default) positions the Looper after the built-in echo (in Classic Looper mode), or delay/reverb models (when using the 1 Switch Looper), which results in those lovely effects that you hear on your input signal also being captured within your loop recordings.

Using the Classic Looper

Similar to the original DL4 device of yore, we've included a similar (but more powerful!) Looper, where you turn the Selector knob to LOOPER, and the device's knobs and switches change their job descriptions from handling model and preset settings to instead covering Looper duties. We've covered all the details here.

NOTE: As mentioned on the previous page, you can also utilize the 1 Switch Looper for loop recording, or for loop playback even if you've recorded your loop using the Classic Looper. Also see the section cleverly titled "[Using the 1 Switch Looper](#)" on page 23.

Using the Classic Looper's Built-in Echo

Let's face it, looping is more fun with some echo thrown into the mix! When you choose the classic LOOPER on the DL4 MkII Selector knob, you'll hear that a terrific little echo effect is built right in. You can utilize the re-purposed knobs to adjust this echo's time, repeats, modulation, and level (see "[Looper Knobs](#)" on page 22).

Looper Footswitches

You'll see that each of the four footswitches include a secondary label beneath—these pertain to their Classic Looper mode functions.

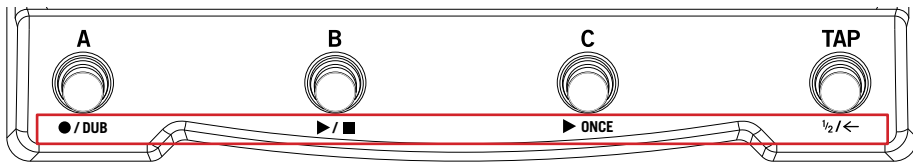

The Looper footswitch labels

● / DUB Record/Overdub

Press this switch start recording your loop. You'll see it light green while it is recording. To stop recording your loop, you can press either the ● / DUB or the ► / ■ switch:

- If you press ● / DUB while recording, this will automatically stop recording your loop and put you into Overdub recording mode, which will continue to cycle your loop, layering whatever you play as an additional overdub on each cycle. You'll see the switch flash to indicate Overdub mode.
- If you press ► / ■ while recording (or while in Overdub), this will immediately end recording and start playback of your recorded loop. You'll see the ● / DUB switch change to unlit to indicate recording has stopped, and the ► / ■ switch lit solid green to indicate playback is active.

You can also enter Overdub anytime once your original loop is recorded. While your loop is playing, press ● / DUB and play—its LED flashes to indicate Overdub mode is active. With each cycle in overdub mode, the already-recorded sound gets a little quieter, fading away entirely after many overdub passes.

NOTE: Any time you press ● / DUB while loop playback is *not* active, this will start recording a new loop and erase whatever was previously recorded.

► / ■ Play/Stop

Once you've recorded a loop you like, you can start and stop playback any time by toggling the Play/Stop switch—you'll see it light solid, bright green when playback is active. From Stop, playback starts from the beginning of the loop.

If you're currently in active playback or overdub mode, pressing this switch stops playback/overdub. You can also press this switch while recording to stop the recording and immediately start loop playback.

► ONCE Play Once

When playback or recording is stopped, press this switch for "one-shot" playback, where your recorded loop plays from the start for its full length and then stops automatically—you'll see both Play Once and Play/Stop light solid, bright green when Play Once is active.

From Record, press ► ONCE to stop recording and start a one-shot playback immediately.

If you're currently in loop playback, press this switch to immediately trigger a one-shot playback of your loop from its start. (You can achieve a dandy "stuttering" effect by repeatedly pressing ► ONCE.)

From Record, press ► ONCE to stop recording and start a one-shot playback immediately.

If you're currently in Overdub mode, press the switch to immediately terminate overdub recording and start Play Once playback, which will stop at the end of the loop.

1/2 / ← Half Speed/Reverse

This is a dual function switch—tap once to change to half speed, and a double-tap to change to reverse. You can even use both at the same time!

Half Speed

Hit this switch with a single tap to go into in half speed, or to return to normal speed. Once you've turned Half Speed on, it stays on until you turn it off, and you'll see it light solid green to indicate when active.

When a loop is playing forward and at normal speed, press this switch once and the loop drops down one octave and plays at half its originally recorded speed. Press this button a second time to return the loop to normal speed.

You can utilize Half Speed for recording as well. Before you start recording, tap this switch once to enable Half Speed and then record your loop. When you play your recorded loop, playback sounds normal (and you've effectively doubled the available loop record time for the device, as an added perk). For the loop you've recorded (and/or overdubbed) at Half Speed, if you tap the switch once again to return to Full Speed, your playback will commence at double the speed at which it was recorded, and pitched an octave higher. Let that sink in for a minute.

Reverse

Double-tap the switch to activate/deactivate Reverse. You'll see the switch's LED flash slowly when Reverse is active.

If you double-tap the switch while your loop is playing, it reverses playback. If you double-tap this the switch again, playback is returned to forward (normal).

It is not possible to toggle Reverse during recording—double-taps of the switch are ignored while record is active. However, once you've got a loop recorded, you can double-tap the switch to reverse your recorded loop's playback, and then record an overdub. Now, if you double-tap the $\frac{1}{2}$ / ← switch, you'll hear normal playback of your original loop, with your overdub reversed!

To really get creative, you can enable and use Half Speed and Reverse at the same time. You'll see the switch's LED flash quickly to indicate when both functions are active.

TIP: You can also access all the same Looper footswitch commands via an external MIDI controller. This opens up some wicked flexibility, considering that you can engage and manipulate Looper functions without needing to touch the device at all—and even trigger multiple functions simultaneously! See "[MIDI](#)" on [page 49](#).

Looper Knobs

When you set the Selector to LOOPER, the other five knobs on DL4 MkII are re-purposed to enhance your looping experience. Most offer control of the Looper's built-in echo, while the MIX knob controls the Looper playback volume (also see "[Using the Classic Looper's Built-in Echo](#)" on [page 21](#)).

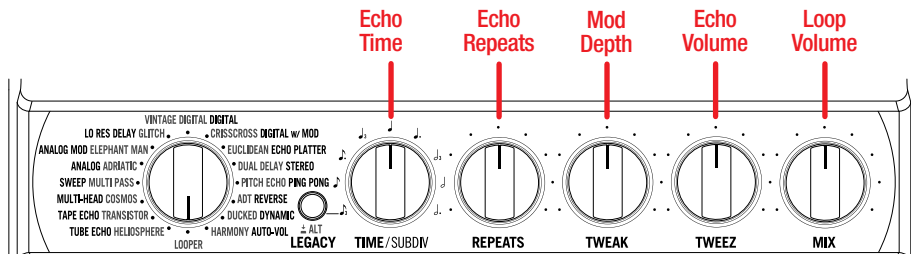

Functions of knobs while in Looper mode

***NOTE:** These alternate knob functions only apply to the Classic Looper, while the Selector knob is set to LOOPER—they do not apply to the 1 Switch Looper.

TIME/SUBDIV (Echo Time)

Twist this knob to set the time for the built-in echo's repeats.

REPEATS (Echo Repeats)

Turn to set the number of audible repeats for the built-in echo. You can set this to minimum to achieve a single repeat, or throw caution to the wind and max the knob to get into some runaway madness.

TWEAK (Mod Depth)

Use to add some swirly modulation to the echo repeats, from none to enough pitchy warble to make you dizzy.

TWEEZ (Echo Volume)

Twist to dial in just the right balance of echo to go along with your input signal. You can set this from all the way left to essentially turn the echo "off," where no echo effect is heard, to all the way right to achieve a 50/50 mix level.

MIX (Loop Volume)

Turn to adjust your loop's playback volume. Set the knob at 50% for unity gain with your input signal - or you might want to reduce this slightly when overdubbing layers to allow your input signal to be easily heard—such as when you're ready to rip into that majestic solo on top of your loop sound-scape.

Classic Looper Tutorial

To follow we've provided a real-world, step-by-step example for using the Classic Looper. Of course, the number of possibilities for how you combine and utilize all the features is practically endless, but you'll get the idea. For this example, we have our DL4 MkII's Global Settings set to their factory defaults (see [page 43](#)).

***NOTE:** Configuring the Global Settings' "Looper Mono/Stereo" and "Looper Pre/Post" options will determine whether your loop recordings are captured in mono, stereo, and with or without the built-in echo effect—see [page 46](#).

1. Set the Selector knob to LOOPER.
2. Turn TWEEZ to minimum to turn off the built-in echo effect, and set MIX to 50%.
3. Start strumming an up-tempo rhythm guitar part. Once you've got a groove, tap the ● / DUB (Record/Overdub) switch once at the downbeat of your measure to start recording your loop.
4. Record four measures of your rhythm, then stomp on the ▶ / ■ (Play/Stop) switch at the downbeat of what would be the fourth measure to stop recording.

Your loop now automatically starts playing back. If you didn't get your timing solid enough to create a good sounding loop, just tap ▶ / ■ to stop playback and repeat step 3 until you capture a worthy performance.

You've now recorded a loop that you can play along with to your heart's content. Turn the MIX knob to adjust the volume of the loop playback as desired. Go to the next step if you want to overdub some lead on top of your loop.

5. Optionally, turn up TWEEZ if you want some echo on your lead. DELAY, TIME, and REPEATS control the echoes, and TWEAK lets you add some modulation.

6. Press ►/■ to start your loop's playback. Once you're ready for your big moment, hit ●/DUB as the loop plays to enter Overdub mode and go wild for four bars.

If you're really feeling fancy, you can keep the overdub running after the first loop cycle and record a second layer for a doubled solo.

7. Hit ►/■ at the end of your four bars to turn off overdub, and your loop will keep playing—now featuring both your rhythm and solo parts.

You can keep repeating step 6 to add additional overdub layers as desired. See the next step for some more fun tricks to try with your loop.

8. Hit the ½/← (Half Speed/Reverse) switch once and you'll hear the whole thing at half speed. Then, double-tap this switch and you'll be playing backwards, and still at half speed.

As the loop plays, tap ●/DUB and lay down some more guitar. Hit ►/■ to stop the overdubbing and play the whole shebang, and then double-tap ½/←.

Now the loop is playing forward again, and the last part you recorded is backward in relation to everything else.

One more tap on ½/← and half speed turns off. You can imagine where a half hour of this kind of thing could get you.

Once you've recorded your loop, you can also access the loop using the 1 Switch Looper. This allows you to play and even add overdubs while not in the Classic Looper mode, where you'll be able to hear your presets' delay and reverb applied to your input signal as you play along with the loop. See the following "[Using the 1 Switch Looper](#)" section.

Using the 1 Switch Looper

All new for the DL4 MkII device, and independent of the afore described Classic Looper, we've included a simple 1 Switch Looper, that you can set up to be accessed easily by—you guessed it—a single switch (your TAP switch, in this case). There is no need to choose LOOPER via the Selector knob. Once you've configured your TAP switch, you can stomp that thing anytime inspiration strikes and indulge in instantaneous loop shenanigans.

When using the 1 Switch Looper, once you've recorded and started playing your loop, you'll continue to hear your current preset's delay and reverb effects applied to your input signal as you play along. All knobs and switches continue to control the delays, reverbs, and preset options.

 **NOTE:** Just as with the Classic Looper, configuring the Global Settings' **Looper Mono/Stereo** and **Looper Pre/Post** options will determine whether your loop recordings are captured in mono, stereo, and with or without your current delay and reverb—see [page 46](#).

1. Configure the Global Setting > TAP switch so that it controls the 1 Switch Looper (see "[TAP Footswitch Assign](#)" on page 44).

Once the TAP switch is configured, you'll see its LED lit dim white, indicating the switch is assigned to control the 1 Switch Looper and no loop is yet recorded.

2. Press the 1 Switch Looper (TAP) switch.

The LED lights bright red, indicating the loop is recording.

3. Press the 1 Switch Looper switch again.

The LED lights bright green, indicating the loop is playing back. You can now jam along endlessly with your loop. Note that you can also still choose and edit the settings for the delay and reverb that continues to be applied to your input signal.

 **TIP:** Note that the loop playback volume level follows the value set within the Classic Looper mode (via the MIX knob). If desired, you can switch to Classic Looper mode to adjust the playback level there and return the Selector to any delay model to continue using the 1 Switch Looper.

4. Press the 1 Switch Looper switch again.

The LED lights bright amber, indicating the loop is in overdub mode. Subsequent presses of the switch toggle between play and overdub mode.

5. While the Looper is in play or overdub mode, press and hold the switch for 1 second.

The most recent recording is undone. Holding the switch again will redo the recording.

6. Quickly double-press the 1 Switch Looper switch.

Playback/recording stops, and the LED lights bright white, indicating a loop is in memory.

7. While Looper playback/recording is stopped, press and hold the switch.

The recording is deleted, and the LED lights dim white.

Once you've recorded a loop, your loop remains in memory until you either manually delete it (as in step 7 above), or power your DL4 MkII off. Note that you can optionally access your current loop using the Classic Looper by turning the Selector knob to LOOPER. This allows you to utilize all the added features within the Classic Looper mode, such as playback level control, half speed, reverse, and more! Also see the "[Classic Looper Tutorial](#)" on page 22.

More Tasty Looping Tidbits

The fun doesn't stop yet—here are more things to explore when using either the Classic or 1 Switch Looper:

- Record some rhythmic muted strums or hits on your guitar to lay down a percussion “track,” over which you can record some overdubs.
- Try recording “volume swells” of guitar chords on an overdub or two for ambient pad backgrounds.
- Use the Mic In for vocals, acoustic instruments, or various bodily functions for some multifarious, layered compositions.
- The Half-Speed and Reverse loop playback options, once enabled within the Classic Looper mode, remain active for the 1 Switch Looper as well. You can temporarily switch the Selector knob to LOOPER to access these functions via the TAP switch, then exit Looper mode and use the 1 Switch Looper.
- Connect an external MIDI controller device to remotely trigger any of the Looper functions. There are even Undo and Redo commands available via MIDI. See ["Controlling the Looper" on page 53](#).
- You can control the Classic Looper knob parameters via expression pedal or footswitches—see ["Controlling The Classic Looper Parameters" on page 17](#).
- Remember that when you record your loop to the DL4 MkII's internal memory, your loop is discarded once you power the device off. But if you record your loop with a microSD card inserted, your last recorded loop remains on the card, even after ejecting and powering your DL4 MkII off.

Effects Models

To follow we've listed all the MkII and Legacy delay models, as well as all the "secret" reverb models, along with what the TWEAK and TWEEZ knobs control for each, within handy tables for quick reference. For more illustrious model and parameter details, please be sure to also see the ["Model Gallery" on page 29](#).

MkII Delays List

To choose one of the MkII delays as your active delay model, toggle the ALT/LEGACY button so that it is not lit, then turn the Selector knob to any of the delay model names that appear in white text.

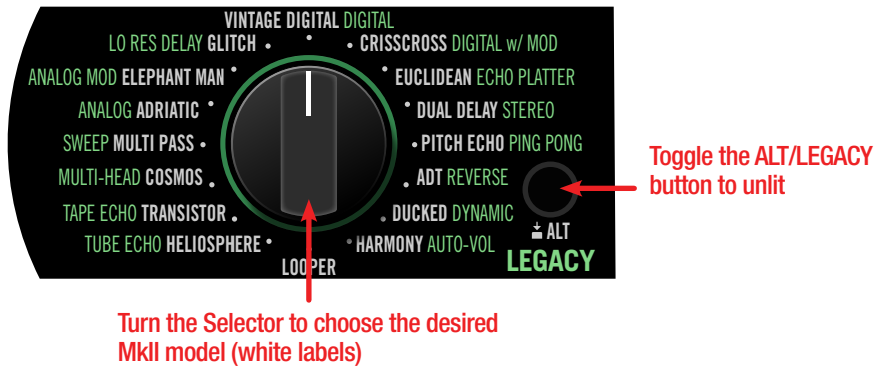

NOTE: The ALT/LEGACY button remains unlit when the Selector knob is set to LOOPER.

MkII Delay Models		
MODEL	TWEAK	TWEEZ
Vintage Digital	Bit Depth and Sample Rate	Mod Depth
Crisscross	Delay Time B	Cross Amount
Euclidean	Step Fill	Rotate
Dual Delay	Right Delay Time	Right Feedback
Pitch Echo	Pitch Interval (-13 to +13 semi-tones)	Pitch Cents (-50 to +50 cents)
ADT	Distortion Deck 2	Mod Depth
Ducked	Threshold	Ducking Amount
Harmony	Key (A — G#)	Pitch Modes
Looper	Echo Mod	Echo Volume
Heliosphere	Reverb Mix and Decay	Mod Depth
Transistor	Headroom	Wow & Flutter
Cosmos	Heads Select (1, 2, 3, 1+3, 2+3, 1+2+3)	Wow & Flutter (increases to right) Feedback Tone (decreases to right)
Multi Pass	Tap Pattern	Delay Mode
Adriatic	Mod Rate	Mod Depth
Elephant Man	Mod Depth	Mode (Chorus/Vibrato)
Glitch	Pitch	Slice Feedback, Sequence Drift, & Shuffle

Legacy Delays List

To choose one of the Legacy delays as your active delay model, toggle the ALT/LEGACY button so that it is lit green, then turn the Selector knob to the desired delay model name that appears in green text.

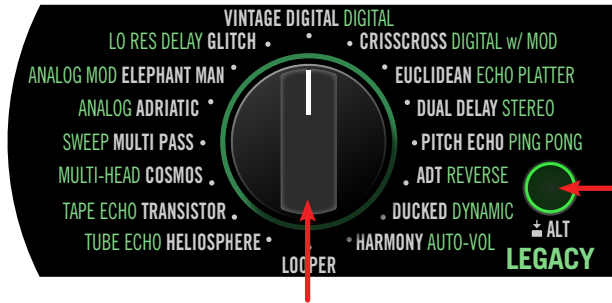

Turn the Selector to choose the desired Legacy model (green labels)

Toggle the ALT/LEGACY button to lit green

NOTE: The ALT/LEGACY button remains unlit when the Selector knob is set to LOOPER.

Legacy Delay Models		
MODEL	TWEAK	TWEEZ
DIGITAL	Bass	Treble
DIGITAL w/ MOD	Mod Rate	Mod Depth
ECHO PLATTER	Wow & Flutter	Drive
STEREO	Right Delay Time (as a % of Left Delay Time)	Right Repeats
PING PONG	Time Offset	Stereo Spread
REVERSE	Mod Rate	Mod Depth
DYNAMIC	Threshold	Ducking
AUTO-VOL	Mod Depth	Swell Time
LOOPER	Echo Mod	Echo Volume
TUBE ECHO	Wow and Flutter	Drive
TAPE ECHO	Bass	Treble
MULTI-HEAD	Heads 1/2 (1-2 off, 1 on, 1-2 on, 2 on)	Heads 3/4 (3-4 off, 3 on, 3-4 on, 4 on)
SWEEP	Sweep Rate	Sweep Depth
ANALOG	Bass	Treble
ANALOG MOD	Mod Rate	Mod Depth
LO RES DELAY	Tone	Resolution

Secret Reverbs List and Controls

The fifteen exquisite reverb models are not labeled on the Selector knob of your DL4 MkII (hence the “secret” nomenclature) but be assured, they are there, lurking within the depths of your device just waiting to be unleashed. You can use any reverb along with your currently active MkII or Legacy delay model—and who wouldn’t want a little bit of reverb along with their delays?

To select a reverb, press and hold the ALT/LEGACY button while turning the Selector knob to the position that corresponds to the desired model.

To follow, we’ve provided an illustration you can use as a “decoder ring” to see where each reverb model is plotted on the Selector dial. You can also reference the handy, printed **Cheat Sheet** that came with your DL4 MkII, or available [here](#).

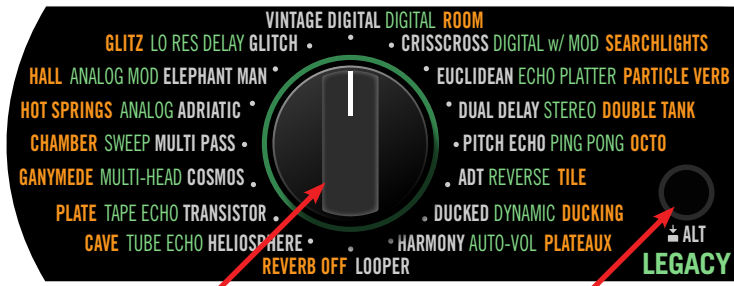

Selector Knob
Turn to choose the desired secret reverb model (added here as orange labels for reference)

ALT/LEGACY Button
Push and hold while turning the Selector knob

The reverbs’ parameters are a bit of a secret as well, but easy to access. Again, just **press and hold the ALT/LEGACY button while turning the knobs**, as shown below.

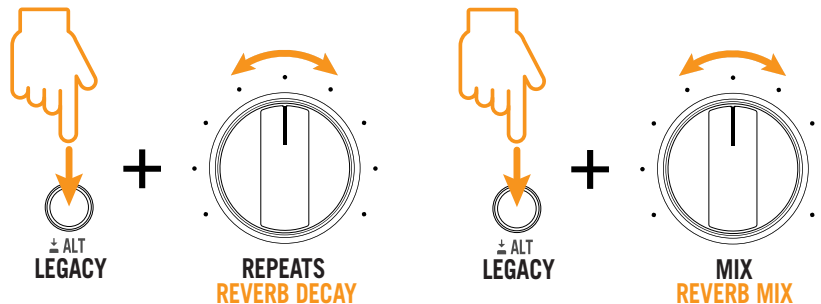

The REPEATS knob controls reverb decay

The MIX knob controls reverb mix

NOTE: The TIME/SUBDIV knob has no function for the reverb models.

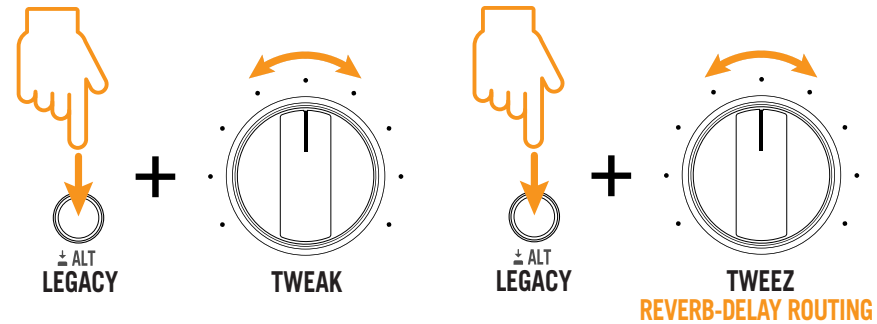

The TWEAK knob controls a different parameter for each reverb model

The TWEEZ knob controls the reverb-delay routing order

See the TWEAK and TWEEZ columns in the following table

Reverb Models		
MODEL	TWEAK	TWEEZ
ROOM	Predelay	When any model selected -
SEARCHLIGHTS	Mod Mix & Intensity	Reverb/Delay signal flow routing:
PARTICLE VERB	Condition	Knob at 0% = Reverb → Delay
DOUBLE TANK	Mod Depth	Knob at 50% = Delay and Reverb in parallel
OCTO	Intensity	Knob at 100% = Delay → Reverb
TILE	Predelay	Also see " on page 12
DUCKING	Predelay	
PLATEAUX	Pitch Modes (in semi-tones): 1 = -24 / -12 2 = -24 / +24 3 = -12 / +12 4 = +12 / +24 5 = -12 / -5 6 = -12 / +7 7 = -5 / +7 8 = +7 / +12	
REVERB OFF	N/A	
CAVE	Predelay	
PLATE	Predelay	
GANYMEDE	Mod Depth	
CHAMBER	Predelay	
HOT SPRINGS	Spring Count	
HALL	Predelay	
GLITZ	Mod Depth	

Common Delay and Reverb Parameters

As you'll see in the above tables, many delays and reverbs include several common parameters via the TWEAK and TWEEZ knobs. To follow are descriptions for these. See the ["Model Gallery" on page 29](#) for more about specific delay and reverb models' options.

 **NOTE:** The parameters controlled via the TWEAK and TWEEZ knobs typically affect only the sound of the delay's repeats or reverb's decay, and do not affect your dry input signal.

Parameter	Description
Time	For delays that offer a secondary channel echo (such as Dual and Stereo types), the TIME/SUBDIV knob adjusts the delay time for the left channel's delay repeats. You can use the TWEAK and TWEEZ knob to configure the right channel's delay repeats. Also see "About Tap Tempo" on page 12 for info on Note Subdivisions for your delay repeats.
Bass	Adjusts the amount of low frequency content. Reducing the bass can remove some boom or mud.
Treble	Adjusts the amount of high frequency content. Reducing the treble can make your repeats blend in and become more of a wash behind your dry signal.
Mod Rate	Adjusts the speed of the pitch modulation, with higher settings providing faster rates, applied to the delay or reverb trails.
Mod Depth	Adjusts the intensity of the pitch modulation. Higher settings result in more extreme pitch bending, wobble, or throb, depending on the model.
Wow & Flutter	Adjusts the amount of the pleasantly lo-fi warble, such as typically inherent with the old tape-based echo units.
Decay	Sets the length of time the reverb effect sustains.
Predelay	Determines the time before the reverb effect is heard. Higher settings emulate a larger space and usually provide a more evident "slap-back" reflection.

 **NOTE:** Be sure to Save your preset after adjusting you delay and reverb models and parameters to your liking—all settings will otherwise be lost once you load a different preset.

Model Gallery

Here we've posted all the delay and reverb models on display, including some historic tidbits covering what classic machines some of these are based on, as well as helpful details for each model's settings and abilities. You can tour the collection by category: ["MkII Delays"](#), ["Legacy Delays"](#), and ["Secret Reverbs"](#)

MkII Delays

This section includes all the MkII delay models included in DL4 MkII, as listed with white labels on your device's Selector knob.

VINTAGE DIGITAL



A Line 6 original.

What collection would be complete without a delay that harkens back to those exciting early 80s rack-mount digital wonders? The earliest digital units sported some pretty lo-fi bit and sample rate specs as compared to even the cheapest of today's gear. But sometimes that digital grit is just the character needed. Put down the hairspray and dial up some modulation to really capture that 80s vibe.

TWEAK adjusts the Bit Depth, from 6 bit to 24 bit, and Sample Rate, from 8 kHz to 48 kHz.

TWEEZ adjusts the Modulation Depth.

CRISSCROSS



A Line 6 original.

A combo of two digital delays (A and B) panned hard left and right, complete with a helping of lower bit/sample rate grunge for flavor. While the TIME/SUBDIV knob offers control of the delay A's time, the TWEAK knob offers delay B's time to be independently controlled. With the "Crossfeed" parameter (via the TWEEZ knob) set at zero, the two delays remain discrete. But things get more interesting as you increase TWEEZ—where the two delays interact and start creating clouds of sound in the middle of your stereo field. Try setting the two delay's times to mathematically unrelated values, and TWEEZ to about 75% for some pleasantly chaotic interaction.

TWEAK adjusts the Time independently for Delay B.*

TWEEZ adjusts the Crossfeed amount.



***NOTE:** As with other delay models, you can press-hold the ALT/LEGACY button and turn the TIME/SUBDIV knob to choose a note subdivision for the delay time to follow. Note that the Crisscross has two delays (A and B)—pressing-holding ALT/LEGACY and turning TIME/SUBDIV sets both delays times to the selected note subdivision value. Also see ["About Tap Tempo" on page 12](#).

**See ["U.S. Registered Trademarks" on page 42](#). All product names used in this document are trademarks of their respective owners and neither Yamaha Guitar Group nor Line 6 are associated or affiliated with them. These trademarks appear solely to identify products whose tones and sounds were studied by Line 6 during sound model development.*

EUCLIDEAN

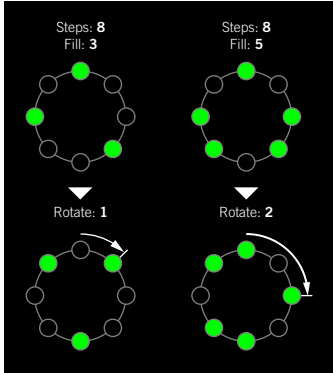

A Line 6 original.

Not just for the geeks in the room, this one is based on Euclidean rhythm algorithms which result in eight-step sequence patterns, as we've attempted to illustrate at the left. Full understanding requires complex diagrams, charts, and whatnot, but feel free to ignore all that and just dive in for some truly unique delay patterns.

REPEATS controls the overall number of repeats heard for the entire sequence. If you want to hear all fills in the sequence only once, set this to 0%.

TWEAK adjusts the Step Fill. Using Euclidean math, this evenly "fills" the sequence with repeats (1-8; see diagram at left).

TWEEZ adjusts Rotate, which fills forward within the sequence by the same amount (see diagram at left). Turn this knob to the right if you like the sound of the repeated pattern, but want the fills and gaps shifted forward.

DUAL DELAY



A Line 6 original.

Why settle for one delay, when you really want two? And why not have them completely discrete, each with their own controls, and panned hard left and right? We knew you'd ask, so that's exactly what this is. Use the TIME/SUBDIV and REPEATS for the Time and Repeats for the left delay, and use TWEAK and TWEEZ for the right.

TWEAK adjusts the Time for the right delay.*

TWEEZ adjusts the number of Repeats for the right delay.

***NOTE:** As with other delay models, you can press-hold the ALT/LEGACY button and turn the TIME/SUBDIV knob to choose a note subdivision for the delay time to follow. Note that the Dual Delay has two delays (Left and Right)—pressing-holding ALT/LEGACY and turning TIME/SUBDIV sets both delays times to the selected note subdivision value. Also see ["About Tap Tempo" on page 12](#).

PITCH ECHO



A Line 6 original.

If you're getting bored with the same old repeats, here's something different. Every time a repeat is heard, its pitch is altered by the semi-tone interval and/or cents that you define (via TWEAK and TWEEZ, respectively), resulting in an auditory ladder of ascending or descending trails. Start with the TIME/SUBDIV, REPEATS, and MIX, each at around 50%, then play around with TWEAK and TWEEZ to dial in the preferred pitch changes. Shift happens.

TWEAK adjusts the Pitch Interval, from -13 to +13 semi-tones.

TWEEZ adjusts the Pitch Cents, from -50 to +50 cents.

*See ["U.S. Registered Trademarks" on page 42](#). All product names used in this document are trademarks of their respective owners and neither Yamaha Guitar Group nor Line 6 are associated or affiliated with them. These trademarks appear solely to identify products whose tones and sounds were studied by Line 6 during sound model development.

ADT



A Line 6 original.

That stands for “Auto Double-Tracker” (or sometimes referred to as “Artificial Double Tracker”) in studio-speak. Early on, savvy recording engineers discovered they could “double-track” vocals and other instruments to fatten up the sound. Shortly after, some other clever studio cats figured out they could use two recording decks simultaneously to capture and playback the same part to “automatically” double-track. The magic would really happen when those old decks would distort a bit and flail in and out of sync ever so slightly. Now you can replicate this process automatically all with this one effect.

Inside DL4 MkII, your input signal is split into two virtual “tape decks,” with the MIX knob allowing you to blend between Deck 1 and Deck 2. You can introduce a bit of Delay Time (0 to 200 milliseconds) to Deck 2 by simply adjusting the TIME/SUBDIV knob to taste.* Additionally, you can try coloring the Deck 2 signal by adding some Wow & Flutter using REPEATS, tape machine Saturation & Distortion via TWEAK, and a bit of swirly Modulation with the TWEEZ knob.

REPEATS adjusts the Wow & Flutter.

TWEAK adjusts the tape Saturation & Distortion.

TWEEZ adjusts the Modulation Depth.

DUCKED



Based on* the TC Electronic® 2290 Dynamic Digital Delay.

We’ve added this new MkII revision of the original DL4’s Dynamic Delay (see [page 36](#)), where the new incarnation includes automatic Attack and Release of the ducking level. This is a sort of “smart” volume control for your delay effect’s echoes, which automatically sets the loudness of the delay repeats based on how hard you play. While you’re playing, the Ducking Delay keeps the volume of the repeats turned down, so that they don’t overwhelm what you’re doing. Then, when you stop playing for a moment, the volume level of the repeats turns up to allow the repeats to be heard.

The TWEAK knob sets the Threshold—as your input level is analyzed, the threshold is the breakpoint level where this automatic volume control stops working and lets the delay repeats through at full volume. The TWEEZ knob adjusts the speed at which the attack and release “ducks” (reduces) and restores the level of the repeats—lower TWEEZ knob settings provide faster attack & release speeds. Try setting TWEAK to approximately 50% and you’ll hear how the delay effect gets partially muted while you play, helping to avoid that unwanted “muddy” sound.

TWEAK adjusts the Threshold value.

TWEEZ adjusts the ducking’s Attack and Release together.

HELIOSPHERE



A Line 6 original.

This is like a tasty combo meal—not only is there a luscious stereo delay with some soft, chewy modulation, but we’ve also thrown in a long, tall reverb to wash it all down. The reverb is applied only to the delay repeats. Use the TIME, REPEATS, and MIX knobs to serve up these aspects of the delay, then use the TWEAK and TWEEZ to ladle on reverb and modulation and raise the calorie count.

TWEAK adjusts the reverb’s Mix and Decay, from none of either at minimum to 100% wet signal only and the longest decay length at maximum.

TWEEZ adjusts the Modulation Depth.

*See “U.S. Registered Trademarks” on [page 42](#). All product names used in this document are trademarks of their respective owners and neither Yamaha Guitar Group nor Line 6 are associated or affiliated with them. These trademarks appear solely to identify products whose tones and sounds were studied by Line 6 during sound model development.

TRANSISTOR



Based on* the Maestro® EP-3.

After introducing the tube-based EP-1 and EP-2 tape echo marvels, Maestro introduced the solid-state EP-3, with transistors instead of tubes for the sound electronics. The EP-3 uses the same basic mechanical design as the original Echoplex, including the looped 1/4" tape, but does not have the tube distortion sound of the EP-1. EP-3s contributed to many classic recordings of the 70s. Eddie Van Halen and Jimmy Page were both avid EP-3 users.

This MkII model incarnation includes enhanced realism, and offers up more of that coveted EP-3 tape saturation. As you reduce the TWEAK knob, the headroom drops, warming the tone up with some pleasant grit. Use the TWEEZ knob to dial in some tape wow & flutter.

TWEAK adjusts the Headroom. Range: -15.2dB to +8.8dB.

TWEEZ adjusts Treble cut or boost. Range: -15.2dB to +8.8dB.

COSMOS



Based on* the Roland® Space Echo RE-201

In 1974 Roland introduced its third iteration of the Space Echo, preceded by the RE-100 (see the "[MULTI-HEAD](#)" Legacy model) and the RE-200. This unit added a spring reverb and additional EQ to its uniquely quirky analog, motor-driven, multi-head design.

Use the TWEEZ knob to select the machine record heads 1 through 3 that are active, to create different tapped delay patterns. The TWEEZ knob does double-duty—your repeats are most clear set at minimum and as you turn the knob to the right, more wow & flutter is added and the feedback tone darkens.

TWEAK selects active Heads: 1, 2, 3, 1+3, 2+3, or 1+2+3.

TWEEZ adjusts both Wow & Flutter (increases to the right), and Feedback Tone (decreases to the right).

MULTI PASS



A Line 6 original.

This multi-tap style delay is infused with automatic filtering, for somewhat of a sweeping, synth type effect. There are eight different "tap patterns," selectable via the TWEAK knob. These patterns each yield different combinations of band pass frequency sweeps, which add interesting, angular rhythm movements to your playing. Use the TWEEZ knob to choose between two different sonic emulation Modes—Delay for a shiny digital character, or Echo for a bit darker, saturated tape vibe.

TWEAK chooses from among eight Tap Patterns.

TWEEZ adjusts the Mode between Delay or Echo.

*See "[U.S. Registered Trademarks](#)" on page 42. All product names used in this document are trademarks of their respective owners and neither Yamaha Guitar Group nor Line 6 are associated or affiliated with them. These trademarks appear solely to identify products whose tones and sounds were studied by Line 6 during sound model development.

ADRIATIC



Based on* the Boss® DM-2 Analog Delay, special Ben Adrian-modded version.

This one is a re-do of the original DL4's DM-2 Analog Delay, this time personally modified by Line 6's own audio architect, Ben Adrian. It features an increased delay time of up to 1.8 seconds, and some sweet modulation added for even more kicks. You'll find this one to be a warm and friendly example of a classic analog delay that really sits comfortably in the mix.

TWEAK adjusts the Modulation Rate.

TWEEZ adjusts the Modulation Depth.

ELEPHANT MAN



Based on* the Electro-Harmonix® Deluxe Memory Man.

As one of the most flavorful delay pedals ever modeled for the original DL4 (see the "[ANALOG MOD](#)" Legacy model), we chose to do this one again as a MkII offering, more authentically matched to the pedal specimen on hand.

The Deluxe Memory Man pedal utilized the warm-sounding "bucket brigade" electronics of other analog echoes of the day, and included a switchable Chorus/Vibrato circuit. Just like the original pedal, our model's delay time has a maximum of 500 milliseconds.

TWEAK adjusts Modulation Depth.

TWEEZ selects the Mode between Chorus or Vibrato.

GLITCH



A Line 6 original.

This twisted brainchild of the Line 6 audio team is a delay that is almost an instrument in itself, where it slices up your input signal and then allows you to repeat the slices as a sequence, with octave and reverse effects applied and shuffled in different repeating variations. This one warrants some more parameter details, which we've provided below—or, as with all delay models, feel free to just twist the knobs and experiment!

TWEAK determines how Octaves are applied to your repeats, with none at minimum and lots of low and high octaves at maximum.

TWEEZ adjusts the Slice Feedback, Sequence Drift, and Shuffle in tandem, with more of each applied as you turn the knob to the right.

Slice Feedback controls the number of repeats heard for individual slices. At higher values, you could call this "Super Chaotic Feedback." (Note that you can also use the REPEATS knob to control the overall number of repeats for the entire sequence.)

Sequence Drift determines the likelihood of the entire sequence changing every time it loops around. When at minimum, the same sequence loops forever.

Shuffle determines the likelihood of repeats shuffling/reordering, with things getting more wonderfully random at higher values.

*See "[U.S. Registered Trademarks](#)" on page 42. All product names used in this document are trademarks of their respective owners and neither Yamaha Guitar Group nor Line 6 are associated or affiliated with them. These trademarks appear solely to identify products whose tones and sounds were studied by Line 6 during sound model development.

Legacy Delays

This section includes all the Legacy DL4 delay models included in DL4 MkII, as listed with green labels on your device's Selector knob.

DIGITAL



A Line 6 original.

This model is a straight-forward digital delay with bass and treble tone controls. The excellent processing quality and true stereo audio path of the DL4 MkII make it one of the best digital delays you'll find.

TWEAK adjusts Bass from -15.2dB to +8.8dB.

TWEEZ adjusts Treble from -15.2dB to +8.8dB.

DIGITAL w/ MOD



A Line 6 original.

Choose this model to add some lush chorus effect to your digital delays. Like the chorus of the Analog Delay w/ Mod, this modulation is applied to the delay repeats only, leaving your direct sound unaffected.

TWEAK adjusts Modulation Speed from 0.05 to 9.40 Hz.

TWEEZ adjusts Modulation Depth from 0% to 100%

ECHO PLATTER



Based on* the Binson® EchoRec®

The Echo Platter was inspired by magnetic platter echo units similar to the Binson EchoRec used by psychedelli-clinicians like Pink Floyd. At the heart of these units is a spinning metal platter and a record/playback head that floated on the platter (kind of like a primitive hard drive!).

This delay is straddles the line between the tube and solid-state Echoplexes in tone, with a very hip Wow and Flutter that you can dial up to suit your mood. Turn up the Drive to dirty things up a bit. See you on the dark side of the moon...

TWEAK adjusts Wow and Flutter from 0% to 100%.

TWEEZ adjusts Drive from 0% to 100%.

*See "U.S. Registered Trademarks" on page 42. All product names used in this document are trademarks of their respective owners and neither Yamaha Guitar Group nor Line 6 are associated or affiliated with them. These trademarks appear solely to identify products whose tones and sounds were studied by Line 6 during sound model development.

STEREO



A Line 6 original.

Stereo delays, my friend... It's one of the secrets of the “Big L.A. Solo” sound of the late 80s. Set one side as a fast echo with many repeats, and the other as a slow delay with just a few repeats. Voila, you're famous!

This model highlights one of the features of your DL4 MkII—the true stereo nature of both the direct path and the delay processing. When you connect and send signals into both the Left and Right Inputs, the signals are kept discrete, processed separately, and passed individually to the Left and Right Outputs (for a mono in/out hookup, left and right delays are both sent to the left/mono out). Thus, your stereo signals that you process with your DL4 MkII will retain their stereo separation, rather than collapsing to mono, as happens with some of those lesser effect units (we're not mentioning any names here).

TIME/SUBDIV sets the Delay Time for the left channel.*

REPEATS sets number of Repeats for the left channel.

TWEAK sets the Delay Time for the right channel.*

TWEEZ sets the number of Repeats for the right channel.



***NOTE:** As with other delay models, you can press-hold the ALT/LEGACY button and turn the TIME/SUBDIV knob to choose a note subdivision for the delay time to follow. Note that the Stereo Delay has two delays (Left and Right)—pressing-holding ALT/LEGACY and turning TIME/SUBDIV sets both delays times to the selected note subdivision value. Also see ["About Tap Tempo" on page 12.](#)

PING PONG



A Line 6 original.

The Ping Pong Delay has two separate channels of delay, with the output of each flowing into the other, going back and forth like an auditory game of ping pong. The TIME/SUBDIV knob sets the overall delay time, and the TWEAK knob sets the time differential between the left and right channels' delays as a percentage value.

If that all sounds a bit too technical, just turn TIME/SUBDIV to set the longer delay's time and turn TWEAK to adjust the shorter delay's time. If you set TWEEZ straight up at 12 o'clock, your delays are panned evenly left and right. As you might guess, this one sounds quite a bit more fun in stereo—but if you're utilizing just the L/MONO output of your device, you'll hear the two delay paths interacting in mono.

TWEAK adjusts the Offset between the two delays from 0% - 98%

TWEEZ adjusts the Stereo Spread from 0% to 100% (at 0%, the signal is mono).

REVERSE



A Line 6 original.

IseltaeB eht dna xirdneH imiJ tsuJ. Take a step back in time with your cool reverse delay. Whatever you play in comes back at you backward, delayed by the time you set with the TIME/SUBDIV knob. To use this little wonder most effectively, try playing a legato lick. Longer licks can translate into very cool reverse phrases. When using Reverse, try setting MIX fully-clockwise (100% wet) so all you hear is the reversed sound— instant backward guitar solo fun.

If you have an expression pedal connected (see ["Setting up an Expression Pedal and Footswitches" on page 14](#)), try setting the pedal's toe-down position to a very short delay time —this will give you a weird “resonant filter” effect. Set the heel-down position to a nice long reverse time. Then start playing and sweep the pedal back from for the hippest time warp ever available for guitar.

TWEAK adjusts Modulation Speed from 0.05 Hz to 9.40 Hz.

TWEEZ adjusts Modulation Depth from 0% to 100%

*See ["U.S. Registered Trademarks" on page 42](#). All product names used in this document are trademarks of their respective owners and neither Yamaha Guitar Group nor Line 6 are associated or affiliated with them. These trademarks appear solely to identify products whose tones and sounds were studied by Line 6 during sound model development.

DYNAMIC



Based on* the TC Electronic 2290 Dynamic Digital Delay.

This is a sort of “smart” volume control for your delay effect’s echoes, which automatically sets the loudness of the delay repeats based on how hard you play. While you’re playing, the Dynamic Delay keeps the volume of the repeats turned down, so that they don’t overwhelm what you’re doing. Then, when you stop playing for a moment, the volume level of the repeats turns up to allow the repeats to be heard.

The TWEAK knob sets the Threshold—as your input signal is analyzed, this is the breakpoint where this automatic volume control stops working and lets the delay repeats through at full volume. The TWEEZ knob adjusts the level of the “ducked” repeats—higher settings will reduce the delay level down more aggressively. Try setting TWEAK and TWEEZ to around 50%, and hear how the delay effect gets partially muted while you play, helping to avoid that unwanted “muddy” sound.

TWEAK adjusts the Threshold from -20dB to -60dB.

TWEEZ adjusts the Ducking from 0 to -138dB

AUTO VOL



A Line 6 original.

This model gives you two effects in one. The Auto-Volume part of the equation is a volume fade-in swell, like the attack time on a synthesizer’s envelope generator. Since, unlike other effects in DL4 MkII, the swell affects your dry signal, this can be used for a bowing effect, like the one you get by turning the volume knob on your guitar quickly up from zero just after you pick a note. Higher settings for the TWEEZ knob will give you a longer swell time, so that the sound slowly fades in, like a wave.

The other effect is an echo, complete with tape-style wow & flutter modulation goodness, adjustable via the TWEAK knob.

TWEAK sets Modulation Depth from 0% to 100%.

TWEEZ sets Ramp Time for the auto-volume swell. Range: 0.030-1.900 seconds

TUBE ECHO



Based on* the 1963 Maestro EP-1

This Maestro unit was the first of a series of “Echoplex” designs distributed by the company and made by Harris-Teller in Chicago. As touted in a Maestro advertisement, the Echoplex’s “...special effects range all the way from a controlled high speed reverberation to a full, throbbing echo!”

The Echoplex design centers on a special cartridge of looped 1/4" tape that wraps past separate record and playback heads. The position of the playback head can be moved to adjust the delay time from 60 to 650 milliseconds. Your DL4 MkII’s Tube Echo emulates the classic Echoplex tone with the extra advantage of up to 2.57 seconds of delay time (and you’ll never need to buy new tape cartridges!).

TWEAK adjusts the emulated tape’s Wow and Flutter from 0-100%

TWEEZ adjusts Drive, which is the amount of distortion created by the unit’s tube electronics and tape saturation.

*See "U.S. Registered Trademarks" on page 42. All product names used in this document are trademarks of their respective owners and neither Yamaha Guitar Group nor Line 6 are associated or affiliated with them. These trademarks appear solely to identify products whose tones and sounds were studied by Line 6 during sound model development.

TAPE ECHO



Based on* the Maestro EP-3.

After the tube-based EP-1 and EP-2, Maestro introduced the solid-state EP-3, with transistors instead of tubes for its preamp electronics. The EP-3 uses the same basic mechanical design as the original Echoplex, including the looped 1/4" tape, but does not have the tube distortion sound of the EP-1.

EP-3s contributed to many classic recordings of the 70s. Eddie Van Halen and Jimmy Page were both avid EP-3 users. Unlike the Tube Echo model based on the EP-1, which gives you control of wow, flutter and distortion, our EP-3 emulation is designed to give you a tape saturation emulation with adjustable tone controls.

TWEAK adjusts Bass response. Range: -15.2dB to +8.8dB.

TWEEZ adjusts Treble. Range: -15.2dB to +8.8dB.

MULTI-HEAD



Based on* the Roland RE-101 Space Echo.

Long before Boss® pedals, the Space Echo was Roland's first venture into the world of effects processing. Instead of having one movable play-back head (like the Echoplex) this machine has multiple stationary heads. You change delay times by switching amongst these heads, and then fine-tune delay time with a motor speed control. The groovy part is that you can play back on multiple heads at the same time to get multi-tap delay effects.

The Multi-Head model has a maximum delay length of 2.57 seconds, with the delay time divided evenly between the 4 heads.

TWEAK turns Heads 1 & 2 off and on.

TWEEZ turns Heads 3 & 4 off and on.

SWEEP



A Line 6 Original.

Starting with the basic tone of our "[TUBE ECHO](#)" EP-1 tape delay emulation, we added a sweeping filter effect to the delay repeats to give you unique new creative possibilities for adjusting the tone of your delays. In technical terms, the TWEAK and TWEEZ knobs adjust the speed and depth of a sine wave used to modulate the tone of the tape emulation. You can use these controls to create and explore your own shifting landscape of tonal possibilities. .

Things get really interesting when you play with the sweep's depth (via the TWEEZ knob, or even better, via an expression pedal!) where you can go from zero to extreme.

TWEAK adjusts the Sweep Speed from 0.1 to 20 Hz.

TWEEZ adjusts the Sweep Depth from 0% to 100%.

*See "[U.S. Registered Trademarks](#)" on page 42. All product names used in this document are trademarks of their respective owners and neither Yamaha Guitar Group nor Line 6 are associated or affiliated with them. These trademarks appear solely to identify products whose tones and sounds were studied by Line 6 during sound model development.

ANALOG



Based on* the Boss DM-2 Delay.

Analog units like the DM-2 Delay were designed as "improvements" over the tape echoes that preceded them, using "bucket brigade" electronics to give guitarists echo units that were more reliable than the tape-based delays, with the added advantage of a low-power circuit that could be run on batteries.

Analog delays are treasured for the warm, distorted tones they produce, and are also great for creating more experimental sounds. Try this, for instance; set the TIME/SUBDIV to 1 second and the REPEATS knob to max and play in some guitar, so the delay circuit "overloads." Now spin the TIME/SUBDIV knob quickly to get something like the sound of a space-aged speeding race car imploding on itself.

TWEAK adjusts the Bass from -15.2dB to +8.8dB.

TWEEZ adjusts the Treble from -15.2dB to +8.8dB.

ANALOG MOD



Based on* the Electro-Harmonix® Deluxe Memory Man.

This pedal uses the "bucket brigade" electronics of other analog echoes, and adds a chorus circuit. This adjustable chorus is applied to the echoes only, leaving the direct sound unaffected. This popular pedal, with its warm, distorted tone and swimming echoes, became an important tool for many guitarists, and was an essential part of the guitar sounds for the first U2 album.

Part of the "Deluxe" in the Deluxe Memory Man was the increased delay time of 500 milliseconds. Your DL4 MkII emulates classic Memory Man tone with the added advantage of 2.5 seconds of delay time.

TWEAK adjusts Modulation Speed from 0.05 to 9.40 Hz.

TWEEZ adjusts Modulation Depth from 0% to 100%.

LO RES DELAY



A Line 6 original.

The first digital delay units were introduced in the early 80s. These pedals and rack units took advantage of emerging digital technology to provide guitarists with longer delay times. Unlike the 16 bit digital format of CDs, and the even higher resolution provided by today's audio gear, these early digital units generally had only 8 bit resolution. Low bit resolution can create a unique sort of grunge and noise that is sometimes just the sound you're looking for, and that's why these old delays are still employed to give a particular shape to the sounds that are run through them.

Try this model on a low resolution setting to get that characteristic digital grunge. Use the TWEEZ knob to adjust its processing anywhere from its normal 24 bit resolution, down to as little as 6 bits. Your direct sound, of course, will not be affected. Tone control of the delay is also provided, via the TWEAK knob.

TWEAK adjusts tone with a Low-Pass Filter ranging from 0.3kHz to 12.0kHz

TWEEZ adjusts digital Resolution from 6 bit (lo-fi) up to 24 bit (hi-fi).

*See "U.S. Registered Trademarks" on page 42. All product names used in this document are trademarks of their respective owners and neither Yamaha Guitar Group nor Line 6 are associated or affiliated with them. These trademarks appear solely to identify products whose tones and sounds were studied by Line 6 during sound model development.

Secret Reverbs

This section includes all the reverb models included on the device, which are accessed by pressing and holding the ALT/LEGACY button while turning the Selector knob. Remember to press and hold the ALT/LEGACY button while turning the REPEATS, TWEAK, TWEEZ, and MIX knobs to adjust the Reverb parameters.

ROOM



A Line 6 original.

This reverb is a more subtle one. As its name suggests, it adds a bit of ambience and the feel of a reflective small room space. It can be a great choice to add some liveliness to your overall sound.

TWEAK sets the Predelay from 0 to 200 milliseconds.

SEARCHLIGHTS



A Line 6 original.

There is nothing subtle about this one—a spacious reverb that sounds like you’re soaring through the clouds. Try turning up the TWEAK to add a dense wash of modulation to the decay.

TWEAK sets Modulation Mix and Intensity from 0% to 100%.

PARTICLE VERB



A Line 6 original.

A big lush ‘verb that additionally layers on some pitch effects for creating dreamy sound-scapes. Try some volume swells from your guitar to create big sustaining pad effects, and switch through the three Conditions via the TWEAK knob to go from smooth to chaotic pitch shifts.

TWEAK sets the Condition: 0-33% = Stable, 34-66% = Critical, 67-100% Hazard.

DOUBLE TANK



A Line 6 original.

The masterminds at Line 6 took advantage of virtual development for this creation, combining the smooth reflections of a plate style reverb with an extra “tank” component as used in our Cave model. The result is a bigger plate with added bounce and texture. You can also turn up the TWEAK knob to create a liquid wash of modulation over the decay.

TWEAK sets Modulation Depth from 0% to 100%.

OCTO



A Line 6 original.

If you’re after an expansive celestial effect to add to your chords, the Octo delivers. It offers a super sized reverb with the added “shimmer” of harmonized tones, reminiscent of an angelic choir singing up above.

TWEAK sets the Intensity from 0% to 100%.

TILE



A Line 6 original.

Way back in the day, some recording studios went to the expense of building a tiled room for capturing natural sound reflections to add some liveliness to the instruments. Now you can add a bright, reflective reverb effect with just the twist of the Selector knob.

TWEAK sets Predelay from 0 to 200 milliseconds.

DUCKING



A Line 6 original.

If you've ever wished that big reverb tail would just get out of the way while you're picking, this one is for you. Much like the ["DUCKED"](#) delay, this Ducking reverb automatically adjusts its mix based on your input signal. While you're playing, it politely stays quieter, and once it detects your playing level drops down, it ramps up its level so the reverb decay is heard on the end of your phrase.

TWEAK sets Predelay from 0 to 200 milliseconds.

PLATEAUX



A Line 6 original.

Plate reverbs were mechanical units consisting essentially of a metal sheet (or "plate") in a box that sound was played into, for which a transducer then picked up and amplified its reflections. Due to the density of the metal plate, the resulting reverberations are very full sounding, with softer reflections and a smooth tail. As a bonus, our Plateaux plate reverb adds two pitch-shifted overtones your signal with a bit of modulation to add color and atmosphere. The **TWEAK** knob offers several different modes for these added pitch shifts. Here's another tip—if you love the sound of the Plateaux reverb, but don't want the added pitch shift embellishments, check out the ["GANYMEDE"](#) (it's essentially the same reverb without the pitch shifting).

TWEAK chooses the Pitch Mode, There are two pitches per Mode (pitches are listed in positive or negative, semi-tone intervals):

Mode 1 = -24 / -12	Mode 5 = -12 / -5
Mode 2 = -24 / +24	Mode 6 = -12 / +7
Mode 3 = -12 / +12	Mode 7 = -5 / +7
Mode 4 = +12 / +24	Mode 8 = +7 / +12

REVERB OFF

If you really just don't care about all that effort we put into the nice reverb models, set the Selector knob to this option to bypass the reverb completely.

CAVE



A Line 6 original.

History tells us that nine out of ten audibly discriminating Neanderthals agreed that nothing was better at enhancing yells and percussive performances than a large subterranean space. Now you can experience what the ancestors did by placing your DL4 MkII tones in the depths of a cavern, figuratively speaking.

TWEAK sets Predelay from 0 to 200 milliseconds.

PLATE



A Line 6 original.

As described for the "[PLATEAUX](#)" model, plate reverbs are regarded as the most smooth and versatile types around. Use the REPEATS (for decay) and MIX to add a little or a lot as needed to burnish just about any type of signal.

TWEAK sets Predelay from 0 to 200 milliseconds.

GANYMEDE



A Line 6 original.

Yet another fine plate-style reverb. This one goes deeper than the Plate model above, with added richness and modulation on tap to really expand your senses. Essentially, the Ganymede is very similar to the "[PLATEAUX](#)" model, but without pitch shifting enhancements.

TWEAK sets Modulation Depth from 0% to 100%.

CHAMBER



A Line 6 original.

In the golden days of R&B and early Rock & Roll, studios often utilized a specially built, reflective chamber to pump music into, which was then re-mixed to capture and add ambience to those classic hits. This model has a slightly warmer texture than other early reverbs and adds a nice retro vibe.

TWEAK sets Predelay from 0 to 200 milliseconds.

HOT SPRINGS



A Line 6 original.

Spring reverbs units were one of the early portable and cost-effective solutions for integrating reverb into those great old tube guitar amps, like your daddy-o has in the basement. They offer a bright, bouncy character that was heavily used in the rockabilly and surf guitar genres, as well as other vintage styles. Our Hot Springs reverb is a bigger and badder incarnation, where you can use the TWEAK knob put up to 3 spring units into action for greater depth.

TWEAK sets the number of Springs in use, from 1 to 3 (and any fractional amount in between).

HALL



A Line 6 original.

This one emulates a large concert hall environment, for when only that grandiose, classical character will do. Turn up the REPEATS knob to see how huge you can make it.

TWEAK sets Predelay from 0 to 200 milliseconds.

GLITZ



A Line 6 original.

In attempts by some sound engineers to soften reverb tails, diffusers were added to reduce reflections. This sometimes also resulted in a “blooming” effect, where the reverberations would feedback on themselves and expand in a unique way. The Glitz reverb has bloom generation built right in—increase the MIX knob to get more of the bloom, and use the TWEAK knob to add modulation for some murky swirl.

TWEAK sets Modulation Depth from 0% to 100%.

U.S. Registered Trademarks

All product names used in this document are trademarks of their respective owners and neither Yamaha Guitar Group nor Line 6 are associated or affiliated with them. These trademarks appear solely to identify products whose tones and sounds were studied by Line 6 during sound model development.

Binson is a registered trademarks of Universal Audio, Inc.

BOSS and Roland are registered trademarks of Roland Corporation U.S.

EchoRec is a registered trademark of Nicholas Harris.

Electro-Harmonix is a registered trademark of New Sensor Corp.

Maestro is a registered trademark of Gibson Guitar Corp.

TC Electronic is a registered trademark of MUSIC Group IP Ltd.

Global Settings

The DL4 MkII Global Settings include parameters that apply to all presets, such as input and output levels, pedal and footswitch behaviors, MIDI options, and more. It's a good idea to review these options listed here since they allow you to customize many aspects of the device to work best for your particular setup.

Accessing the Global Settings

To enter the Global Settings mode on your device, use the following steps:

1. **Press and hold the ALT/LEGACY button, press the TAP footswitch, and then release both.**

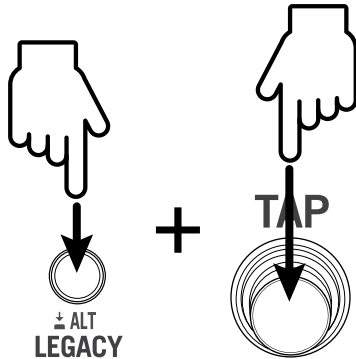

You'll see all footswitch LEDs go dark and the ALT/LEGACY button's LED lit with a color other than green to indicate you have entered the Global Settings. Note that the ALT/LEGACY button's LED color is an important indicator for referencing your selected options, as you'll see in the following steps.

2. **Referring to the Global Settings table on the next page, turn the device's Selector knob to choose the specific Global option you wish to configure.**

For example, as documented within the ["Global Settings Table" on page 44](#):

To configure the **Tempo Preset/Global** option, turn the Selector knob to **VINTAGE DIGITAL/DIGITAL**. Or...

To configure the **TAP Footswitch Assign**, turn the Selector knob to **CRISSCROSS/DIGITAL w/MOD**, etc.

3. **Consult the table once again, this time referring to the "Values - ALT/LEGACY LED Color" column for the Global Setting you selected in the previous step. Push and release the ALT/LEGACY button repeatedly to cycle through the colored LED options to choose the one you prefer.**

For example, if you've selected the **Tempo Preset/Global** setting in the previous step, you have two choices: **Per Preset** (indicated by a red colored LED ●) or **Global** (indicated by a white colored LED ●).

For this **Tempo Preset/Global** setting, the button's LED is initially lit red, since **Per Preset** is the factory default.* If you want to keep this default setting, keep the ALT/LEGACY button set to red. To change to **Global**, press the button to where it is lit white.

***NOTE:** Within the Global Settings table, the **factory default** option is indicated for each setting with the ✓ symbol.

As you can see in the table, some Global Settings have several options, for which each will be indicated by one of five different LED colors: red ●, white ●, blue ●, orange ●, or yellow ●.

4. **Repeat steps 2 and 3 to configure any additional Global Settings.**
5. **Once you've made all the desired changes, press any footswitch to exit Global Settings and your changes are automatically retained.**

You can repeat these steps anytime to edit your Global Settings.

Global Settings Table

Global Settings			
Setting	Selector Knob Position	Values ALT/LEGACY LED Color	Description
<p>✔ Indicates the factory default value for each global setting.</p>			
Tempo Preset/Global	VINTAGE DIGITAL DIGITAL	<input type="radio"/> Per Preset (red) ✔ <input type="radio"/> Global (white)	<p>Set the behavior for the device's Tap Tempo to be either per preset or global:</p> <ul style="list-style-type: none"> – Tempo is saved and recalled individually, per preset. – Tempo is applied globally to all presets. Choose this option if you prefer the tempo does not change until you manually change it.
TAP Footswitch Assign	CRISSCROSS DIGITAL w/MOD	<input type="radio"/> Tap Tempo (red) ✔ <input type="radio"/> 1 Switch Looper (white) <input type="radio"/> Expression Toggle (blue) <input type="radio"/> Squeal (orange) <input type="radio"/> Preset DEF (yellow)	<p>Configure the desired function for the TAP Footswitch:</p> <ul style="list-style-type: none"> – Stomp the switch several times to "tap" in a tempo. The switch LED flashes red to indicate the current tempo. – Use the switch to access and control the 1 Switch Looper. The LED lights dim white (see "Using the 1 Switch Looper" on page 23). – When configured to control a parameter, the switch toggles between two values, emulating the "heel" and "toe" positions of an expression pedal controller. The LED lights dim blue to indicate heel position, and bright blue for toe position. – Pressing and holding the switch momentarily sets the delay's REPEATS parameter to 100%, allowing you to get the infinite delay repeats effect on demand! Releasing the switch returns the REPEATS to its previous setting. The switch LED lights dim orange, and appears bright orange while held. – Pressing the switch changes between the preset banks "ABC" (the LED lights dim yellow) and "DEF" (the LED lights bright yellow).
Footswitch 5 Assign	EUCLIDEAN ECHO PLATTER	<input type="radio"/> Tap Tempo (red) <input type="radio"/> Looper On/Off (white) <input type="radio"/> Expression Toggle (blue) ✔ <input type="radio"/> Squeal (orange)	<p>Configure the desired function for the optional Footswitch 5: (Note that you'll additionally need to configure the "EXP Pedal - FS 5/6 Jack Assign" global setting as "FS 5/6" for a connected FS 5 to be functional.)</p> <ul style="list-style-type: none"> – Stomp the switch several times to "tap" in a tempo. – Use the switch to toggle between the currently-loaded preset and the Classic Looper. – When configured to control a parameter (such as Delay - Mix), the switch toggles between two values, much like the "heel" and "toe" positions of an expression pedal controller. – Pressing and holding the switch momentarily sets the delay's REPEATS parameter to 100%, allowing you to get the infinite delay repeats effect on demand! Releasing the switch returns the REPEATS to its previous setting.

Global Settings

Setting	Selector Knob Position	Values ALT/LEGACY LED Color	Description
✔ Indicates the factory default value for each global setting.			
Footswitch 6 Assign	DUAL DELAY STEREO	<input type="radio"/> Tap Tempo (red) <input type="radio"/> Looper On/Off (white) <input type="radio"/> Expression Toggle (blue) <input checked="" type="radio"/> Squeal (orange) ✔	Configure the desired function for optional Footswitch 6: – Stomp the switch several times to “tap” in a tempo. – Use the switch to toggle between the currently-loaded preset and the Classic Looper. – When configured to control a parameter (such as Delay - Mix), the switch toggles between two values, much like the “heel” and “toe” positions of an expression pedal controller. – Pressing and holding the switch momentarily sets the delay’s REPEATS parameter to 100%, allowing you to get the infinite delay repeats effect on demand! Releasing the switch returns the REPEATS to its previous setting.
N/A	PITCH ECHO PING PONG		(Reserved for potential future Global Setting.)
Pedal Jack Functionality	ADT REVERSE	<input type="radio"/> EXP Pedal Only (red) ✔ <input type="radio"/> Single Footswitch (white) <input type="radio"/> EXP Pedal + Footswitch (blue) <input type="radio"/> Two Footswitches (orange)	Configure the EXP PEDAL - FS 5/6 jack for either pedal + switch or dual switch functionality (see "Setting up an Expression Pedal and Footswitches" on page 14): – Accommodates a single expression pedal, connected using a TS cable. – Accommodates a single footswitch, connected using a TS cable. [The footswitch triggers FS5] – Accommodates an expression pedal and a single footswitch, connected using a Y cable (two TS to a TRS). [The footswitch triggers FS6] – Accommodates two footswitches, connected either as a dual footswitch using a TRS cable, or two individual footswitches using a Y cable (to TS to a TRS). [FS5=Tip, FS6=Ring]
EXP/Switch Polarity	DUCKED DYNAMIC	<input type="radio"/> Normal (red) ✔ <input type="radio"/> Inverted (white)	Configure the +/- polarity for your connected EXP PEDAL and footswitches. If your pedal or footswitch is controlling parameters backward, try changing this setting. – Pedal jack accommodates a Line 6 or Mission expression pedal. – Pedal jack accommodates a Yamaha or similar expression pedal. Note that this setting also inverts the polarity for Footswitches 5 and 6.

Global Settings

Setting	Selector Knob Position	Values ALT/LEGACY LED Color	Description
✔ Indicates the factory default value for each global setting.			
Looper Mono/ Stereo	HARMONY AUTO-VOL	<input type="radio"/> Mono (red) <input checked="" type="radio"/> Stereo (white) ✔	<p>Configure the Looper as mono or stereo.* This setting applies to both the classic and 1 Switch Looper:</p> <ul style="list-style-type: none"> – The Looper records in mono. – The Looper records in stereo. <p>*Note that mono and stereo behaviors also depend upon the following “Looper Pre/Post Position” global setting:</p> <p>When Looper is set to “Pre,” the mono/stereo behavior follows the Input jack’s sensing:</p> <ul style="list-style-type: none"> • If the Right Input is connected, a newly recorded loop can be mono or stereo, depending on the Mono/Stereo setting. • If the Right Input is not connected, a newly recorded loop is mono, regardless of the Mono/Stereo setting. <p>When Looper is set to “Post” (the factory default), the mono/stereo behavior follows the Output jack’s sensing:</p> <ul style="list-style-type: none"> • If the Right Output is connected, a newly recorded loop can be mono or stereo, depending on the Mono/Stereo setting. • If the Right Output is not connected, a newly recorded loop is mono, regardless of the Mono/Stereo setting.
Looper Pre/ Post Position	LOOPER	<input type="radio"/> Pre (red) <input checked="" type="radio"/> Post (white) ✔	<p>Configure how you prefer the Looper to be positioned in respect to the effects within the signal flow. This setting applies to both the Classic and 1 Switch Loopers. Note that this Pre/Post setting also impacts the Looper Mono/Stereo global setting—see previous item.</p> <ul style="list-style-type: none"> – The Looper is positioned before the delay and reverb effects. (Delay and reverb effects are heard on your input signal, but not captured in loop recordings.) – The Looper is positioned after the delay and reverb effects. (Delay and reverb effects are heard on your input signal and captured in loop recordings.)
Dry Path	TUBE ECHO HELIOSHPERE	<input type="radio"/> Analog (red) <input checked="" type="radio"/> DSP (white) ✔	<p>Configure the properties of your non-effected, “Dry Path” signal through the device:</p> <ul style="list-style-type: none"> – The dry signal is sent through the device without any digital conversion. The MIX knob controls the blend of the dry (analog) and the wet (digital) signals. – The dry signal is converted to digital and the combined wet/dry signal is controlled via the MIX knob.

Global Settings

Setting	Selector Knob Position	Values ALT/LEGACY LED Color	Description
✔ Indicates the factory default value for each global setting.			
Bypass Trails	TAPE ECHO TRANSISTOR	<input type="radio"/> Off (red) ✔ <input type="radio"/> On (white)	Set whether the "trails" of your current delay and reverb effects are heard when you bypass DL4 MkII: – The delay and/or reverb's trails are abruptly muted when you press the active A, B, or C preset footswitch to bypass DL4 MkII. – The current delay and/or reverb trails decay naturally when you press the active preset footswitch to bypass DL4 MkII.
Bypass Type	MULTI-HEAD COSMOS	<input type="radio"/> True (red) <input checked="" type="radio"/> Buffered (white) ✔ [Bypass Trails on] <input type="radio"/> DSP (blue) [Bypass Trails On] <input type="radio"/> Dry Kill (orange) [Bypass Trails on]	Select your preferred Bypass behavior for DL4 MkII (also see "What Type of Bypass?" on page 11): – Your input signal continues to be sent directly through DL4 MkII with no A/D/A conversion, and all DSP is bypassed. (MIC IN is muted when bypassed in this mode.) – Your input continues to be sent directly through DL4 MkII with no A/D/A conversion, its signal to the DSP is muted, and the DSP's existing delay/reverb trails are allowed to decay naturally. – Your input is sent through the DSP path along with delay/reverb, but any further delay/reverb processing is bypassed. Any existing delay/reverb trails are allowed to decay naturally. – All input is completely muted, but the DSP's echoes decay naturally.
MIDI Channel	SWEEP MULTI PASS	<input checked="" type="radio"/> Channel 1 (red) ✔ <input type="radio"/> Channel 2 (white) <input type="radio"/> Channel 3 (blue) <input type="radio"/> Channel 4 (orange) <input type="radio"/> Assigned based on next received PC message (yellow)	Choose the MIDI Channel the DL4 MkII uses for MIDI In and Out. Once the ALT/LEGACY button is set to yellow, DL4 MkII will listen for a Program Change message sent on any MIDI Channel 1 - 16. DL4 MkII will then "learn" the received MIDI Channel and set it as the new MIDI Channel for sending and receiving.
MIDI THRU	ANALOG ADRIATIC	<input type="radio"/> Off (red) <input checked="" type="radio"/> On (white) ✔	Choose whether DL4 MkII's MIDI THRU is active or not: Does not send incoming MIDI messages out the MIDI OUT/THRU or USB MIDI ports. Sends incoming MIDI messages out the MIDI OUT/THRU and USB MIDI ports.

Global Settings

Setting	Selector Knob Position	Values ALT/LEGACY LED Color	Description
✔ Indicates the factory default value for each global setting.			
Receive MIDI Clock	ANALOG MOD ELEPHANT MAN	<input type="radio"/> Off (red) <input type="radio"/> On (white) <input checked="" type="radio"/> Auto (blue) ✔	Choose whether DL4 MkII receives and syncs to incoming MIDI Clock messages. See "Using MIDI Clock for Tempo Sync" on page 49. – DL4 MkII uses only its internal tempo and ignores any incoming MIDI Clock messages. Note that incoming MIDI Clock is still routed to MIDI THRU. – DL4 MkII automatically syncs to incoming MIDI Clock. You cannot enter your own tempo manually via the DL4 MkII TAP switch. – DL4 MkII automatically syncs to incoming MIDI Clock tempo, and allows you to still enter your own tempo via the DL4 MkII TAP switch.
N/A	LO RES DELAY GLITCH		(Reserved for potential future Global Setting.)

MIDI

With great power comes great responsibility—therefore, we did the responsible thing and provided robust MIDI external control for you to take command of your DL4 MkII's presets, parameters, looping, tempo, and more.

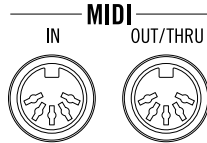

- Connect the MIDI output of your external MIDI controller device to the DL4 MkII MIDI IN, and DL4 MkII will respond to MIDI Program Change (PC), Note On, MIDI CC, and MIDI Clock messages, as covered within this chapter.
-  When connected to your computer, DL4 MkII also receives and transmits the same MIDI messages via USB (with the exception of MIDI Clock messages, which can only be received for sync and routed to MIDI THRU).
- Connect DL4 MkII's MIDI OUT/THRU to your other MIDI gear (or connect USB to your computer) to optionally pass any incoming MIDI messages "THRU" to another device or computer app.
 - DL4 MkII does not transmit MIDI messages for any of its own actions, but will pass incoming MIDI out via its MIDI OUT/THRU and USB MIDI ports.

 **NOTE:** To disable MIDI THRU, configure the Global Settings - "[MIDI THRU](#)" on page 47 option to **Off** (it is **On** as the factory default setting).

- All MIDI control is global, meaning, all commands listed in this chapter will control their respective DL4 MkII functions regardless of the currently loaded preset.

 **NOTE:** DL4 MkII uses MIDI channel 1 as the factory default, but this can be changed via the Global Settings - "[MIDI Channel](#)" on page 47.

Using MIDI Clock for Tempo Sync

DL4 MkII can receive MIDI Clock via its MIDI IN, as well as via USB MIDI, to allow you to sync the tempo from other effects devices and computer applications. Use the Global Settings - "[Receive MIDI Clock](#)" option to set the desired MIDI clock option:

- **Off** - DL4 MkII ignores MIDI Clock messages received.* The tempo can be set manually by tapping on the TAP footswitch.

 ***NOTE:** Whenever MIDI Clock is sent to DL4 MkII, even if the Receive MIDI Clock option is set to Off, the MIDI Clock data is routed "THRU," out DL4 MkII's MIDI OUT/THRU and USB MIDI ports, allowing other connected devices to follow the MIDI Clock for tempo sync. Use the Global Settings - "[MIDI THRU](#)" on page 47 option to disable it if desired.

- **On** - DL4 MkII syncs to incoming MIDI Clock messages. While set to On, presses of the TAP footswitch are ignored.
- **Auto** - DL4 MkII syncs to incoming MIDI Clock messages. The TAP switch's LED flashes blue once MIDI Clock sync is established. While set to Auto, tempo can optionally be set manually by tapping on the TAP footswitch.

 **NOTE:** If you manually tap a tempo on DL4 MkII with MIDI Clock set to Auto, the TAP switch LED flashes at your new tempo while remaining blue.

Once you've selected the preferred **Auto** or **On** option described above, use the following steps to sync DL4 MkII to your source MIDI Clock device's tempo.

1. **Connect your source MIDI Clock device's MIDI OUT to DL4 MkII's MIDI IN port. Or, USB-connect DL4 MkII to your computer and select the DL4 MkII USB MIDI port within your MIDI/DAW software.**
2. **On the source device, set the desired tempo rate and start the MIDI Clock send.**
3. **Once DL4 MkII receives the MIDI Clock "start" command, you'll see DL4 MkII's TAP switch LED change to flashing blue to indicate it is actively following the received MIDI Clock tempo rate.**

When MIDI Clock is stopped on the source device, you'll see the TAP switch LED return to flashing red, and the tempo remains at the last synced tempo rate.

If the Global Settings > "[Tempo Preset/Global](#)" is set to **Per Preset** (the default option), when changing to a different preset, the TAP Tempo rate will change to the new preset's saved tempo rate. You'll see the TAP switch LED flashing blue at the new rate.

Accessing all 128 Presets

As covered on [page 10](#), you can recall the first six presets (A-F) via the devices on-board footswitches. But with the power of **MIDI Program Change (PC)** messages, you can individually access any of the 128 preset locations that reside within your device. Configure your MIDI controller to send PC messages as shown in the following table. Please also see "[Loading Presets 1 - 128 via MIDI](#)" on [page 10](#).

Preset Change - MIDI Program Change Messages

Message	Function
PC 000	Preset A
PC 001	Preset B
PC 002	Preset C
PC 003	Preset D
PC 004	Preset E
PC 005	Preset F
PC 006 ~ 127	Presets 7 ~128
	NOTE: Presets 7 through 128 are not accessible on the DL4 MkII device itself—only via MIDI!

 **NOTE:** In the table above, we're listing the Program Change message values as ranging from "000" to "127," which follows the MIDI Specification. Within the software or hardware displays of some MIDI controllers, however, the range can be shown as "001" to "128." If your MIDI controller happens to display 001 - 128, just know that you'll need to send "PC 001" for DL4 MkII preset A, "PC 002" for preset B, "PC 006" for preset 7, etc.

Controlling Parameters

If you really want to get into some serious real-time, remote control, MIDI CCs are the ticket! Configure your MIDI controller device to send the following CCs to DL4 MkII, and the corresponding parameters will respond accordingly. As indicated in the following table's **Device Responds In:** titled column, the device will respond to some MIDI commands only while in Preset Mode, only in Classic Looper mode, or in both modes.

Parameter Control - MIDI CC Messages			
CC	Parameter or Function	CC Value	Device Responds In:
CC1	Delay Model Select	MkII Delays: 0 = Vintage Digital 1 = Crisscross 2 = Euclidean 3 = Dual Delay 4 = Pitch Echo 5 = ADT 6 = Ducked 7 = Harmony 8 = Heliosphere 9 = Transistor 10 = Cosmos 11 = Multi Pass 12 = Adriatic 13 = Elephant Man 14 = Glitch Legacy Delays: 15 = Digital 16 = Digital w/ Mod 17 = Echo Platter 18 = Stereo 19 = Ping Pong 20 = Reverse 21 = Dynamic 22 = Auto-Vol 23 = Tube Echo 24 = Tape Echo 25 = Multi-Head 26 = Sweep 27 = Analog 28 = Analog Mod 29 = Lo Res Delay	Preset mode
CC2	Reverb Model Select	Reverbs: 0 = Room 1 = Searchlights 2 = Particle Verb 3 = Double Tank 4 = Octo 5 = Tile 6 = Ducking 7 = Plateaux 8 = Cave 9 = Plate 10 = Ganymede 11 = Chamber 12 = Hot Springs 13 = Hall 14 = Glitz 15 = Reverb Off	Preset mode
CC3	Emulates expression pedal	0-127	Preset and Classic Looper modes
CC4	Preset Bypass (same as pressing the active preset switch)	0-63: Enables preset (Bypass Off); 64-127: Bypasses preset (Bypass On)	Preset mode
CC9	Classic Looper Mode On/Off	0-63: Classic Looper mode Off; 64-127: Classic Looper mode On	Preset and Classic Looper modes

Parameter Control - MIDI CC Messages

CC	Parameter or Function	CC Value	Device Responds In:
CC11	Delay Time	0-127 = 0-100%	Preset and Classic Looper modes
CC12	Time Subdivisions - Note Values	0 = 1/8 Triplet 1 = 1/8 2 = 1/8 Dotted 3 = 1/4 Triplet 4 = 1/4 5 = 1/4 Dotted 6 = 1/2 Triplet 7 = 1/2 8 = 1/2 Dotted	Preset mode
CC13	Delay Repeats (Feedback)	0-127	Preset and Classic Looper modes
CC14	Delay Tweak	0-127	Preset and Classic Looper modes
CC15	Delay Tweez	0-127	Preset and Classic Looper modes
CC16	Delay/Looper Mix knob	0-127	Preset and Classic Looper modes
CC17	Reverb Decay	0-127	Preset mode
CC18	Reverb Predelay/Diffusion	0-127	Preset mode
CC19	Reverb-Delay Routing	0 = Reverb before delay 1 = Reverb and delay in parallel 2 = Reverb after delay	Preset mode
CC20	Reverb Mix (DSP Dry Path) / Reverb Level (Analog Dry Path)	0-127	Preset mode
CC64	TAP Tempo	64-127	Preset and Classic Looper modes

Controlling the Looper

With the use of either **MIDI Note On** or **MIDI CC** messages, you can control all aspects of the Looper. Be sure to read through ["Using the Looper" on page 19](#) to get familiar with all functions, then try sending the following MIDI messages to DL4 MkII for your looping performance. Incidentally, Line 6 follows Yamaha's MIDI note spec, where middle C is "C3" (unlike some other gear manufacturers that prefer to say middle C is "C4").

 **NOTE:** DL4 MkII will respond to the following MIDI Looper commands regardless if the device is currently in the Classic Looper mode or not. However, you won't see any switch LED indication of the current Looper function (record, play, overdub, etc.) unless you turn the Classic Looper Mode on, or have the Global Settings > TAP switch configured to control the 1 Switch Looper.

Looper Control - MIDI Note On Messages

Message	Function
Note C -1	Toggles on each press between Record and Overdub
Note D -1	Toggles on each press between Play and Stop
Note E -1	Play Once
Note F -1	Record
Note F# -1	Toggles on each press between Undo and Redo, for overdub recordings
Note G -1	Overdub
Note G# -1	Toggles on each press between Forward and Reverse
Note A -1	Play
Note A# -1	Toggles on each press between Half Speed and Full Speed
Note B -1	Stop

Looper Control - MIDI CC Messages

CC	Value	Function
0	0-63: Off 64-127: On	Classic Looper Mode On/Off
60	0-63: Overdub 64-127: Record	Record/Overdub
61	0-63: Stop; 64-127: Play	Play/Stop
62	64-127	Play Once
63	0-63: Undo; 64-127: Redo	Undo/Redo overdub recordings
65	0-63: Forward 64-127: Reverse	Forward/Reverse
66	0-63: Full; 64-127: Half	Full Speed/Half Speed

 **TIP:** You can also utilize MIDI CCs to control the Classic Looper's built-in Echo parameters while in Classic Looper mode—see the table within ["Controlling Parameters" on page 51](#).

Additional Resources

Product Specifications

DL4 MkII Specifications	
Delays	30
Reverbs	15
Looper	Yes, with both a 4-Switch and 1-Switch Looper user interface
Mono/Stereo	Mono or stereo input and output
USB	USB-C port - for potential future firmware updates and USB MIDI control via computer
SD Card	1 x microSD card slot - for expanded Looper memory
Audio Inputs	2 x 1/4" unbalanced Left (mono) and Right, Instrument level, Impedance = 1 M Ω , Max input level = +11.25 dBu (8Vpp) 1 x XLR Mic In, with preamp
Audio Outputs	2 x 1/4" unbalanced Left (mono) and Right, Instrument level, Impedance = 100 Ohms
MIDI	MIDI 5-pin IN and OUT/THRU USB MIDI In and OUT/THRU - for use via computer applications
Power Requirements	9VDC, 500mA, center pin negative, 2.1 mm. It is recommended to use the included Line 6 DC-1g power adapter
Dimensions (H x W x D)	2 x 9.25 x 4.5 inches / 5.1 x 23.5 x 11.4 cm
Weight	2.03 lbs. / .92 kg

Online Resources

Looking for more info? We've got plenty of online resources, just a click away:

- See our DL4 MkII tutorial videos at line6.com/meet-dl4mkii.
- Download additional Help documentation covering DL4 MkII and all other Line 6 gear at [Line 6 Product Manuals](#)
- Check out the [Line 6 Support](#) page for access to helpful tips, videos, discussion forums, or to contact Line 6 Technical Support
- Can't get enough Line 6 Gear & accessories? Head on over to the [Line 6 Store](#)

